



2017

Bushes - Metallic

Your Search Ends Here

Included in This Catalogue:

- Flanged and unflanged
- Aluminium
- Sintered Bronze
- Solid Bronze
- Steel with PTFE lining



Also Available Not in This Catalogue:

- Sintered bronze bar and tube
- Spherical OD sintered bushes
- Sintered Bronze Washers

To find and order parts online, simply type the part number from this catalogue into the search box on any web page.

Prefixes and Suffixes

B F 00953 - 01270 - 01905 - BS

1 2 3 4 5 6

Bush Designation:
1 B: Bush

Nominal Length:
5 Two decimal place indication of nominal length in mm - eg 01905 = 19.05 Long
(refer size listing and tolerances for accuracy)

Configuration:
2 F: Flanged
P: Plain
SP: Spherical OD (not listed in catalogue)

Material:
6 AF: Solid Aluminium - PTFE Lined
BC9: Solid Bronze C93200 Grade
BFG: Sintered Bronze Food Grade ECO841
BLG: Solid Bronze LG2 Grade
BS: Sintered Bronze
BSO: Oilite Brand Sintered Bronze
DU: PTFE Lined Split Steel Bush
DP4: Split Bush for Oil Pumps
DUB: Bronze Backed Split Bush
SS6: PTFE Lined Stainless Split Bush

3 Nominal Inside Dia.
Two decimal place indication of nominal inside diameter in mm - eg 00953 = 9.53 ID
(refer size listing and tolerances for accuracy)

4 Nominal Outside Dia.:
4 Two decimal place indication of nominal outside diameter in mm - eg 01270 = 12.70 OD
(refer size listing and tolerances for accuracy)

These are just some of the most commonly used suffixes. Please refer to MBA for information on suffixes not listed.

Diagrams

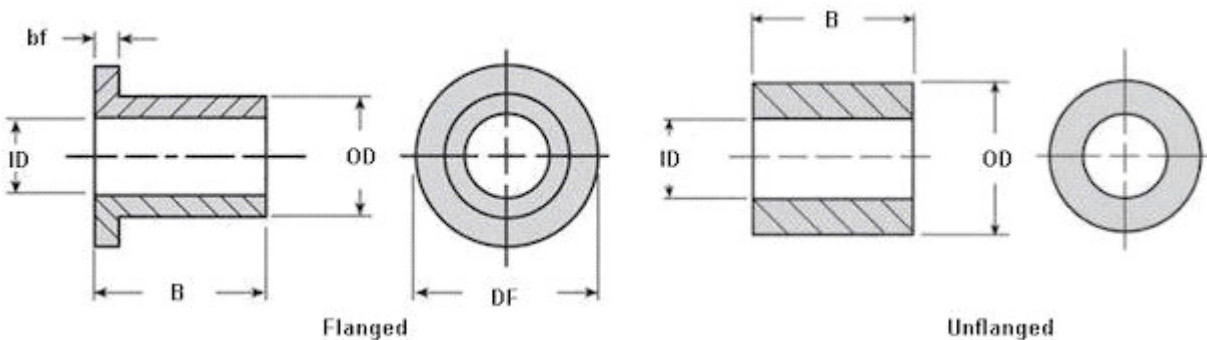

Only the most common diagrams are shown. Other types are also listed in this catalogue.

ID	OD	B	DF	bf	Part Number	Type
1.191 x 3.969 mm (0.047 x 0.156 in.)						
1.191 +0.005/-0.005	3.969 +0.001/-0.004	1.588 +0/-0.127			BP00119-00397-00159-BS	Bushes - Bronze - Sintered - Unflanged
1.191 +0.005/-0.005	3.969 +0.001/-0.012	1.588 +0/-0.127	5.16	0.33	BF00119-00397-00159-BS	Bushes - Bronze - Sintered - Flanged
1.191 +0.005/-0.005	3.969 +0.001/-0.004	2.380 +0/-0.127			BP00119-00397-00238-BS	Bushes - Bronze - Sintered - Unflanged
1.191 +0.005/-0.005	3.969 +0.001/-0.012	2.380 +0/-0.127	5.16	0.79	BF00119-00397-00238-BS	Bushes - Bronze - Sintered - Flanged
1.191 x 4.763 mm (0.047 x 0.188 in.)						
1.191 +0.200/+0.210	4.763 +0.003/-0.002	1.984 +0/-0.127			BP00119-00476-00198-BS	Bushes - Bronze - Sintered - Unflanged
1.191 +0.200/+0.210	4.763 +0.003/-0.010	1.984 +0/-0.127	5.94	0.58	BF00119-00476-00198-BS	Bushes - Bronze - Sintered - Flanged
1.191 +0.200/+0.210	4.763 +0.003/-0.002	2.779 +0/-0.127			BP00119-00476-00278-BS	Bushes - Bronze - Sintered - Unflanged
1.191 +0.200/+0.210	4.763 +0.003/-0.010	2.779 +0/-0.127	5.94	0.79	BF00119-00476-00278-BS	Bushes - Bronze - Sintered - Flanged
1.588 x 4.763 mm (0.063 x 0.188 in.)						
1.588 +0.007/-0.003	4.763 +0.003/-0.002	2.380 +0/-0.127			BP00159-00476-00238-BS	Bushes - Bronze - Sintered - Unflanged
1.588 +0.007/-0.003	4.763 +0.003/-0.010	2.779 +0/-0.127	5.94	0.79	BF00159-00476-00278-BS	Bushes - Bronze - Sintered - Flanged
1.588 x 6.350 mm (0.063 x 0.250 in.)						
1.588 +0.007/-0.003	6.350 +0.003/-0.002	2.380 +0/-0.127			BP00159-00635-00238-BS	Bushes - Bronze - Sintered - Unflanged
1.588 +0.007/-0.003	6.350 +0.003/-0.010	2.380 +0/-0.127	7.52	0.79	BF00159-00635-00238-BS	Bushes - Bronze - Sintered - Flanged
1.984 x 6.350 mm (0.078 x 0.250 in.)						
1.984 +0.010/-0	6.350 +0.003/-0.002	2.380 +0/-0.127			BP00198-00635-00238-BS	Bushes - Bronze - Sintered - Unflanged
1.984 +0.010/-0	6.350 +0.003/-0.010	2.380 +0/-0.127	7.52	0.58	BF00198-00635-00238-BS	Bushes - Bronze - Sintered - Flanged
1.984 +0.010/-0	6.350 +0.003/-0.002	3.571 +0/-0.127			BP00198-00635-00357-BS	Bushes - Bronze - Sintered - Unflanged
1.984 +0.010/-0	6.350 +0.003/-0.010	3.571 +0/-0.127	7.52	0.79	BF00198-00635-00357-BS	Bushes - Bronze - Sintered - Flanged
2.000 x 3.500 mm (0.079 x 0.138 in.)						
2.000 -0.000/-0.006	3.500 +0.008/-0.000	3.000 +0.25/-0.25			BP00200-00350-00300-DUB	Bushes - Steel - DUB - Split - Unflanged
2.000 -0.000/-0.006	3.500 +0.008/-0.000	3.000 +0.25/-0.25			BP00200-00350-00300-DP4	Bushes - Steel - DP4 - Split - Unflanged
2.000 -0.000/-0.006	3.500 +0.008/-0.000	3.000 +0.25/-0.25			BP00200-00350-00300-DU	Bushes - Steel - DU - Split - Unflanged
2.000 -0.000/-0.006	3.500 +0.008/-0.000	5.000 +0.25/-0.25			BP00200-00350-00500-DUB	Bushes - Steel - DUB - Split - Unflanged
2.000 -0.000/-0.006	3.500 +0.008/-0.000	5.000 +0.25/-0.25			BP00200-00350-00500-DU	Bushes - Steel - DU - Split - Unflanged
2.000 x 4.000 mm (0.079 x 0.157 in.)						
2.000 +0.014/+0.024	4.000 +0.015/+0.027	3.000 +0/-0.200			BP00200-00400-00300-BS	Bushes - Bronze - Sintered - Unflanged
2.000 +0.014/+0.024	4.000 +0.015/+0.027	4.000 +0/-0.200			BP00200-00400-00400-BS	Bushes - Bronze - Sintered - Unflanged
2.000 +0.014/+0.024	4.000 +0.015/+0.027	4.000 +0/-0.200	6.00	1.50	BF00200-00400-00400-BS	Bushes - Bronze - Sintered - Flanged
2.000 x 5.000 mm (0.079 x 0.197 in.)						
2.000 +0.002/+0.012	5.000 +0.019/+0.031	2.000 +/-0.070			BP00200-00500-00200-BSO	Bushes - Bronze - Sintered - Unflanged - Oilite
2.000 +0.014/+0.024	5.000 +0.015/+0.027	3.000 +0/-0.200			BP00200-00500-00300-BS	Bushes - Bronze - Sintered - Unflanged
2.000 +0.002/+0.012	5.000 +0.019/+0.031	3.000 +/-0.070			BP00200-00500-00300-BSO	Bushes - Bronze - Sintered - Unflanged - Oilite
2.000 +0.002/+0.012	5.000 +0.019/+0.031	3.000 +/-0.070	8.00	2.00	BF00200-00500-00300-BSO	Bushes - Bronze - Sintered - Flanged - Oilite
2.381 x 4.763 mm (0.094 x 0.188 in.)						
2.381 +0.010/-0	4.763 +0.003/-0.002	1.588 +0/-0.127			BP00238-00476-00159-BS	Bushes - Bronze - Sintered - Unflanged
2.381 +0.010/-0	4.763 +0.003/-0.010	1.588 +0/-0.127	5.94	0.46	BF00238-00476-00159-BS	Bushes - Bronze - Sintered - Flanged

Stocked or Short Delivery

Usually Available

Long delivery or not in current production

ID	OD	B	DF	bf	Part Number	Type
2.381 x 4.763 mm (0.094 x 0.188 in.)						
2.381 +0.010/-0	4.763 +0.003/-0.002	2.380 +0/-0.127			BP00238-00476-00238-BS	Bushes - Bronze - Sintered - Unflanged
2.381 +0.010/-0	4.763 +0.003/-0.010	2.380 +0/-0.127	5.94	0.79	BF00238-00476-00238-BS	Bushes - Bronze - Sintered - Flanged
2.381 x 6.350 mm (0.094 x 0.250 in.)						
2.381 +0.010/-0	6.350 +0.003/-0.002	1.588 +0/-0.127			BP00238-00635-00159-BS	Bushes - Bronze - Sintered - Unflanged
2.381 x 7.938 mm (0.094 x 0.313 in.)						
2.381 +0.010/-0	7.938 +0.003/-0.002	2.779 +0/-0.127			BP00238-00794-00278-BS	Bushes - Bronze - Sintered - Unflanged
2.381 +0.010/-0	7.938 +0.003/-0.010	2.779 +0/-0.127	9.12	0.58	BF00238-00794-00278-BSN	Bushes - Bronze - Sintered - Flanged
2.381 +0.010/-0	7.938 +0.003/-0.010	2.779 +0/-0.127	9.12	0.79	BF00238-00794-00278-BS	Bushes - Bronze - Sintered - Flanged
2.381 +0.010/-0	7.938 +0.003/-0.002	3.571 +0/-0.127			BP00238-00794-00357-BS	Bushes - Bronze - Sintered - Unflanged
2.381 +0.010/-0	7.938 +0.003/-0.010	3.571 +0/-0.127	9.12	0.79	BF00238-00794-00357-BS	Bushes - Bronze - Sintered - Flanged
2.500 x 6.000 mm (0.098 x 0.236 in.)						
2.500 +0.014/+0.024	6.000 +0.015/+0.027	3.000 +0/-0.200	9.00	1.50	BF00250-00600-00300-BS	Bushes - Bronze - Sintered - Flanged
3.000 x 4.500 mm (0.118 x 0.177 in.)						
3.000 -0.000/-0.006	4.500 +0.008/-0.000	3.000 +0.25/-0.25			BP00300-00450-00300-DP4	Bushes - Steel - DP4 - Split - Unflanged
3.000 -0.000/-0.006	4.500 +0.008/-0.000	3.000 +0.25/-0.25			BP00300-00450-00300-DU	Bushes - Steel - DU - Split - Unflanged
3.000 -0.000/-0.006	4.500 +0.008/-0.000	4.000 +0.25/-0.25	7.00	0.70	BF00300-00450-00400-DUB	Bushes - Steel - DUB - Split - Flanged
3.000 -0.000/-0.006	4.500 +0.008/-0.000	4.000 +0.25/-0.25	7.00	1.00	BF00300-00450-00400-DU	Bushes - Steel - DU - Split - Flanged
3.000 -0.000/-0.006	4.500 +0.008/-0.000	4.000 +0.25/-0.25	7.00	1.00	BF00300-00450-00400-DP4	Bushes - Steel - DP4 - Split - Flanged
3.000 -0.000/-0.006	4.500 +0.008/-0.000	5.000 +0.25/-0.25			BP00300-00450-00500-DU	Bushes - Steel - DU - Split - Unflanged
3.000 -0.000/-0.006	4.500 +0.008/-0.000	6.000 +0.25/-0.25			BP00300-00450-00600-DU	Bushes - Steel - DU - Split - Unflanged
3.000 -0.000/-0.006	4.500 +0.008/-0.000	6.000 +0.25/-0.25			BP00300-00450-00600-DUB	Bushes - Steel - DUB - Split - Unflanged
3.000 -0.000/-0.006	4.500 +0.008/-0.000	6.000 +0.25/-0.25			BP00300-00450-00600-DP4	Bushes - Steel - DP4 - Split - Unflanged
3.000 x 5.000 mm (0.118 x 0.197 in.)						
3.000 +0.014/+0.024	5.000 +0.015/+0.027	3.000 +0/-0.200			BP00300-00500-00300-BS	Bushes - Bronze - Sintered - Unflanged
3.000 +0.002/+0.012	5.000 +0.019/+0.031	3.000 +/-0.070			BP00300-00500-00300-BSO	Bushes - Bronze - Sintered - Unflanged - Oilite
3.000 +0.014/+0.024	5.000 +0.015/+0.027	4.000 +0/-0.200			BP00300-00500-00400-BS	Bushes - Bronze - Sintered - Unflanged
3.000 +0.002/+0.012	5.000 +0.019/+0.031	4.000 +/-0.090			BP00300-00500-00400-BSO	Bushes - Bronze - Sintered - Unflanged - Oilite
3.000 +0.014/+0.024	5.000 +0.015/+0.027	4.000 +0/-0.200	8.00	1.50	BF00300-00500-00400-BS	Bushes - Bronze - Sintered - Flanged
3.000 +0.014/+0.024	5.000 +0.015/+0.027	6.000 +0/-0.200			BP00300-00500-00600-BS	Bushes - Bronze - Sintered - Unflanged
3.000 +0.002/+0.012	5.000 +0.019/+0.031	6.000 +/-0.090			BP00300-00500-00600-BSO	Bushes - Bronze - Sintered - Unflanged - Oilite
3.000 x 6.000 mm (0.118 x 0.236 in.)						
3.000 +0.010/-0	6.000 +0/-0.008	2.500 +0/-0.170			BP00300-00600-00250-BS	Bushes - Bronze - Sintered - Unflanged
3.000 +0.010/-0	6.000 +0/-0.008	2.500 +0/-0.178	8.00	0.50	BF00300-00600-00250-BS	Bushes - Bronze - Sintered - Flanged
3.000 +0.002/+0.012	6.000 +0.019/+0.031	3.000 +/-0.070			BP00300-00600-00300-BSO	Bushes - Bronze - Sintered - Unflanged - Oilite
3.000 +0.002/+0.012	6.000 +0.019/+0.031	4.000 +/-0.090			BP00300-00600-00400-BSO	Bushes - Bronze - Sintered - Unflanged - Oilite
3.000 +0.014/+0.024	6.000 +0.015/+0.027	4.000 +0/-0.200	9.00	1.50	BF00300-00600-00400-BS	Bushes - Bronze - Sintered - Flanged
3.000 +0.002/+0.012	6.000 +0.019/+0.031	4.000 +/-0.090	9.00	2.00	BF00300-00600-00400-BSO	Bushes - Bronze - Sintered - Flanged - Oilite
3.000 x 8.000 mm (0.118 x 0.315 in.)						
3.000 +0.010/-0	8.000 +0/-0.009	3.000 +0/-0.170			BP00300-00800-00300-BS	Bushes - Bronze - Sintered - Unflanged

Stocked or Short Delivery

Usually Available

Long delivery or not in current production

ID	OD	B	DF	bf	Part Number	Type
3.000 x 8.000 mm (0.118 x 0.315 in.)						
3.000 +0.010/-0	8.000 +0/-0.009	3.000 +0/-0.178	10.00	0.50	BF00300-00800-00300-BS	Bushes - Bronze - Sintered - Flanged
3.000 x 10.000 mm (0.118 x 0.394 in.)						
3.000 +0.010/-0	10.000 +0/-0.009	4.000 +0/-0.170			BP00300-01000-00400-BS	Bushes - Bronze - Sintered - Unflanged
3.000 +0.010/-0	10.000 +0/-0.009	4.000 +0/-0.178	12.00	1.00	BF00300-01000-00400-BS	Bushes - Bronze - Sintered - Flanged
3.175 x 4.763 mm (0.125 x 0.188 in.)						
3.175 -0.018/-0.036	4.763 +0.076/-0.051	3.175 +0.25/-0.25			BP00318-00476-00318-DU	Bushes - Steel - DU - Split - Unflanged
3.175 +0.025/+0.050	4.763 +0.052/+0.077	3.175 +/-0.127			BP00318-00476-00318-BS	Bushes - Bronze - Sintered - Unflanged
3.175 -0.018/-0.036	4.763 +0.076/-0.051	3.175 +0.25/-0.25			BP00318-00476-00318-SS6	Bushes - Stainless Steel and PTFE - Unflanged
3.175 -0.018/-0.036	4.763 +0.076/-0.051	3.175 +0.25/-0.25			BP00318-00476-00318-DP4	Bushes - Steel - DP4 - Split - Unflanged
3.175 -0.018/-0.036	4.763 +0.076/-0.051	4.763 +0.25/-0.25			BP00318-00476-00476-SS6	Bushes - Stainless Steel and PTFE - Unflanged
3.175 -0.018/-0.036	4.763 +0.076/-0.051	4.763 +0.25/-0.25			BP00318-00476-00476-DP4	Bushes - Steel - DP4 - Split - Unflanged
3.175 -0.018/-0.036	4.763 +0.076/-0.051	4.763 +0.25/-0.25			BP00318-00476-00476-DU	Bushes - Steel - DU - Split - Unflanged
3.175 +0.025/+0.050	4.763 +0.039/+0.064	5.791 +0/-0.305	6.35	0.89	BF00318-00476-00579-BS	Bushes - Bronze - Sintered - Flanged
3.175 +0.025/+0.050	4.763 +0.052/+0.077	6.350 +/-0.127			BP00318-00476-00635-BS	Bushes - Bronze - Sintered - Unflanged
3.175 x 5.556 mm (0.125 x 0.219 in.)						
3.175 +0.013/-0.013	5.556 +0.045/+0.070	3.099 +0/-0.178	8.64	1.27	BF00318-00556-00310-BS	Bushes - Bronze - Sintered - Flanged
3.175 +0.025/+0.051	5.556 +0.045/+0.070	3.759 +0/-0.178	8.76	1.55	BF00318-00556-00376-BS	Bushes - Bronze - Sintered - Flanged
3.175 x 6.350 mm (0.125 x 0.250 in.)						
3.175 +0.010/-0	6.350 +0.003/-0.002	2.380 +0/-0.127			BP00318-00635-00238-BS	Bushes - Bronze - Sintered - Unflanged
3.175 +0.010/-0	6.350 +0.003/-0.010	2.380 +0/-0.127	7.52	0.58	BF00318-00635-00238-BS	Bushes - Bronze - Sintered - Flanged
3.175 +0.010/-0	6.350 +0.003/-0.002	2.779 +0/-0.127			BP00318-00635-00278-BS	Bushes - Bronze - Sintered - Unflanged
3.175 +0.010/-0	6.350 +0.003/-0.010	2.779 +0/-0.127	7.52	0.79	BF00318-00635-00278-BS	Bushes - Bronze - Sintered - Flanged
3.175 +0.0254/+0.0508	6.350 +0.0508/+0.0762	3.175 +0.127/-0.127			BP00318-00635-00318-BS	Bushes - Bronze - Sintered - Unflanged
3.175 +0.0254/+0.0508	6.350 +0.0508/+0.0762	3.175 +0.127/-0.127			BP00318-00635-00318-BFG	Bushes - Bronze - Sintered - ECO841 Food Grade - Unflanged
3.175 +0.025/+0.051	6.350 +0.026/+0.051	3.175 +/-0.127	9.14	1.19	BF00318-00635-00318-BS	Bushes - Bronze - Sintered - Flanged
3.175 +0.025/+0.051	6.350 +0.026/+0.051	6.350 +/-0.127			BP00318-00635-00635-BS05	Bushes - Bronze - Sintered - Unflanged
3.175 +0.025/+0.050	6.350 +0.051/+0.076	6.350 +0/-0.152			BP00318-00635-00635-BS06	Bushes - Bronze - Sintered - Unflanged
3.175 +0.0254/+0.0508	6.350 +0.0508/+0.0762	6.350 +0.127/-0.127			BP00318-00635-00635-BFG	Bushes - Bronze - Sintered - ECO841 Food Grade - Unflanged
3.175 +0.025/+0.051	6.350 +0.026/+0.051	6.350 +/-0.127	9.14	1.19	BF00318-00635-00635-BS	Bushes - Bronze - Sintered - Flanged
3.175 +0.0254/+0.0508	6.350 +0.0508/+0.0762	9.525 +0.127/-0.127			BP00318-00635-00953-BS	Bushes - Bronze - Sintered - Unflanged
3.175 +0.0254/+0.0508	6.350 +0.0508/+0.0762	9.525 +0.127/-0.127			BP00318-00635-00953-BFG	Bushes - Bronze - Sintered - ECO841 Food Grade - Unflanged
3.175 +0.025/+0.051	6.350 +0.026/+0.051	9.525 +/-0.127	9.14	1.19	BF00318-00635-00953-BS	Bushes - Bronze - Sintered - Flanged
3.175 +0.025/+0.050	6.350 +0.051/+0.076	10.516 +0/-0.102			BP00318-00635-01052-BS	Bushes - Bronze - Sintered - Unflanged
3.175 x 7.938 mm (0.125 x 0.313 in.)						
3.175 +0.010/-0	7.938 +0.003/-0.010	2.779 +0/-0.127	9.12	0.58	BF00318-00794-00278-BS	Bushes - Bronze - Sintered - Flanged
3.175 +0.010/-0	7.938 +0.003/-0.002	2.781 +0/-0.127			BP00318-00794-00278-BS	Bushes - Bronze - Sintered - Unflanged
3.175 +0.010/-0	7.938 +0.003/-0.002	3.571 +0/-0.127			BP00318-00794-00357-BS	Bushes - Bronze - Sintered - Unflanged
3.175 +0.010/-0	7.938 +0.003/-0.010	3.571 +0/-0.127	9.12	0.79	BF00318-00794-00357-BS	Bushes - Bronze - Sintered - Flanged

 Stocked or Short Delivery

 Usually Available

 Long delivery or not in current production

ID	OD	B	DF	bf	Part Number	Type
3.175 x 7.938 mm (0.125 x 0.313 in.)						
3.175 +0.025/+0.050	7.938 +0.038/+0.063	6.350 +/-0.127	9.53	1.19	BF00318-00794-00635-BS	Bushes - Bronze - Sintered - Flanged
3.175 +0.025/+0.050	7.938 +0.038/+0.063	9.525 +/-0.127	9.53	1.19	BF00318-00794-00953-BS	Bushes - Bronze - Sintered - Flanged
3.175 x 9.525 mm (0.125 x 0.375 in.)						
3.175 +0.010/-0	9.525 +0.003/-0.002	2.779 +0/-0.127			BP00318-00953-00278-BS	Bushes - Bronze - Sintered - Unflanged
3.175 +0.010/-0	9.525 +0.003/-0.010	2.779 +0/-0.127	10.72	0.58	BF00318-00953-00278-BS	Bushes - Bronze - Sintered - Flanged
3.175 +0.010/-0	9.525 +0.003/-0.002	3.571 +0/-0.127			BP00318-00953-00357-BS	Bushes - Bronze - Sintered - Unflanged
3.175 +0.010/-0	9.525 +0.003/-0.010	3.571 +0/-0.127	10.72	0.79	BF00318-00953-00357-BS	Bushes - Bronze - Sintered - Flanged
3.937 x 5.556 mm (0.155 x 0.219 in.)						
3.937 -0.022/-0.039	5.556 +0.009/-0.004	3.969 +0.25/-0.25			BP00394-00556-00397-DP4	Bushes - Steel - DP4 - Split - Unflanged
3.937 -0.022/-0.039	5.556 +0.009/-0.004	3.969 +0.25/-0.25			BP00394-00556-00397-DU	Bushes - Steel - DU - Split - Unflanged
3.937 -0.022/-0.039	5.556 +0.009/-0.004	3.969 +0.25/-0.25			BP00394-00556-00397-SS6	Bushes - Stainless Steel and PTFE - Unflanged
3.937 -0.022/-0.039	5.556 +0.009/-0.004	6.350 +0.25/-0.25			BP00394-00556-00635-SS6	Bushes - Stainless Steel and PTFE - Unflanged
3.937 -0.022/-0.039	5.556 +0.009/-0.004	6.350 +0.25/-0.25			BP00394-00556-00635-DP4	Bushes - Steel - DP4 - Split - Unflanged
3.937 -0.022/-0.039	5.556 +0.009/-0.004	6.350 +0.25/-0.25			BP00394-00556-00635-DU	Bushes - Steel - DU - Split - Unflanged
3.969 x 6.350 mm (0.156 x 0.250 in.)						
3.969 +0.025/+0.050	6.350 +0.051/+0.076	3.175 +/-0.127			BP00397-00635-00318-BS	Bushes - Bronze - Sintered - Unflanged
3.969 +0.025/+0.050	6.350 +0.051/+0.076	4.750 +/-0.127			BP00397-00635-00475-BS	Bushes - Bronze - Sintered - Unflanged
3.969 +0.025/+0.050	6.350 +0.051/+0.076	6.731 +/-0.127			BP00397-00635-00673-BS	Bushes - Bronze - Sintered - Unflanged
3.969 x 7.938 mm (0.156 x 0.313 in.)						
3.969 +0.010/-0	7.938 +0.003/-0.002	2.779 +0/-0.127			BP00397-00794-00278-BS	Bushes - Bronze - Sintered - Unflanged
3.969 +0.010/-0	7.938 +0.003/-0.010	2.779 +0/-0.127	9.12	0.58	BF00397-00794-00278-BS	Bushes - Bronze - Sintered - Flanged
3.969 +0.010/-0	7.938 +0.003/-0.002	3.175 +0/-0.127			BP00397-00794-00318-BS	Bushes - Bronze - Sintered - Unflanged
3.969 +0.010/-0	7.938 +0.003/-0.010	3.175 +0/-0.127	9.12	0.91	BF00397-00794-00318-BS	Bushes - Bronze - Sintered - Flanged
4.000 x 5.500 mm (0.157 x 0.217 in.)						
4.000 -0.000/+0.008	5.500 +0.015/-0.000	3.000 +0.25/-0.25			BP00400-00550-00300-DU	Bushes - Steel - DU - Split - Unflanged
4.000 -0.000/+0.008	5.500 +0.015/-0.000	4.000 +0.25/-0.25			BP00400-00550-00400-DUB	Bushes - Steel - DUB - Split - Unflanged
4.000 -0.000/+0.008	5.500 +0.015/-0.000	4.000 +0.25/-0.25			BP00400-00550-00400-DP4	Bushes - Steel - DP4 - Split - Unflanged
4.000 -0.000/+0.008	5.500 +0.015/-0.000	4.000 +0.25/-0.25			BP00400-00550-00400-DU	Bushes - Steel - DU - Split - Unflanged
4.000 -0.000/+0.008	5.500 +0.008/-0.000	4.000 +0.25/-0.25	9.00	0.70	BF00400-00550-00400-DUB	Bushes - Steel - DUB - Split - Flanged
4.000 -0.000/+0.008	5.500 +0.008/-0.000	4.000 +0.25/-0.25	9.00	1.00	BF00400-00550-00400-DP4	Bushes - Steel - DP4 - Split - Flanged
4.000 -0.000/+0.008	5.500 +0.008/-0.000	4.000 +0.25/-0.25	9.00	1.00	BF00400-00550-00400-DU	Bushes - Steel - DU - Split - Flanged
4.000 -0.000/+0.008	5.500 +0.015/-0.000	6.000 +0.25/-0.25			BP00400-00550-00600-DU	Bushes - Steel - DU - Split - Unflanged
4.000 -0.000/+0.008	5.500 +0.015/-0.000	6.000 +0.25/-0.25			BP00400-00550-00600-DUB	Bushes - Steel - DUB - Split - Unflanged
4.000 -0.000/+0.008	5.500 +0.015/-0.000	10.000 +0.25/-0.25			BP00400-00550-01000-DP4	Bushes - Steel - DP4 - Split - Unflanged
4.000 -0.000/+0.008	5.500 +0.015/-0.000	10.000 +0.25/-0.25			BP00400-00550-01000-DU	Bushes - Steel - DU - Split - Unflanged
4.000 x 7.000 mm (0.157 x 0.276 in.)						
4.000 +0.004/+0.016	7.000 +0.023/+0.038	4.000 +/-0.090			BP00400-00700-00400-BSO	Bushes - Bronze - Sintered - Unflanged - Oilite
4.000 +0.004/+0.016	7.000 +0.023/+0.038	6.000 +/-0.090			BP00400-00700-00600-BSO	Bushes - Bronze - Sintered - Unflanged - Oilite

Stocked or Short Delivery

Usually Available

Long delivery or not in current production

ID	OD	B	DF	bf	Part Number	Type
4.000 x 8.000 mm (0.157 x 0.315 in.)						
4.000 +0.012/-0	8.000 +0/-0.009	4.000 +0/-0.170			BP00400-00800-00400-BS	Bushes - Bronze - Sintered - Unflanged
4.000 +0.004/+0.016	8.000 +0.023/+0.038	4.000 +/-0.090			BP00400-00800-00400-BSO	Bushes - Bronze - Sintered - Unflanged - Oilite
4.000 +0.012/-0	8.000 +0/-0.009	4.000 +0/-0.178	10.00	1.00	BF00400-00800-00400-BS	Bushes - Bronze - Sintered - Flanged
4.000 +0.004/+0.016	8.000 +0.023/+0.038	4.000 +/-0.090	12.00	2.00	BF00400-00800-00400-BSO	Bushes - Bronze - Sintered - Flanged - Oilite
4.000 +0.020/+0.032	8.000 +0.019/+0.034	6.000 +0/-0.200			BP00400-00800-00600-BS	Bushes - Bronze - Sintered - Unflanged
4.000 +0.004/+0.016	8.000 +0.023/+0.038	6.000 +/-0.090			BP00400-00800-00600-BSO	Bushes - Bronze - Sintered - Unflanged - Oilite
4.000 +0.020/+0.032	8.000 +0.019/+0.034	6.000 +0/-0.200	10.00	1.50	BF00400-00800-00600-BS	Bushes - Bronze - Sintered - Flanged
4.000 +0.004/+0.016	8.000 +0.023/+0.038	6.000 +/-0.090	12.00	2.00	BF00400-00800-00600-BSO	Bushes - Bronze - Sintered - Flanged - Oilite
4.000 +0.020/+0.032	8.000 +0.019/+0.034	8.000 +0/-0.200			BP00400-00800-00800-BS	Bushes - Bronze - Sintered - Unflanged
4.000 +0.004/+0.016	8.000 +0.023/+0.038	8.000 +/-0.110	12.00	2.00	BF00400-00800-00800-BSO	Bushes - Bronze - Sintered - Flanged - Oilite
4.000 +0.004/+0.016	8.000 +0.023/+0.038	12.000 +/-0.130	12.00	2.00	BF00400-00800-01200-BSO	Bushes - Bronze - Sintered - Flanged - Oilite
4.763 x 6.350 mm (0.188 x 0.250 in.)						
4.763 +0.025/+0.050	6.350 +0.051/+0.076	4.750 +/-0.127			BP00476-00635-00475-BS	Bushes - Bronze - Sintered - Unflanged
4.762 -0.025/-0.043	6.350 +0.076/-0.076	4.763 +0.25/-0.25			BP00476-00635-00476-DU	Bushes - Steel - DU - Split - Unflanged
4.762 -0.025/-0.043	6.350 +0.076/-0.076	4.763 +0.25/-0.25			BP00476-00635-00476-SS6	Bushes - Stainless Steel and PTFE - Unflanged
4.762 -0.025/-0.043	6.350 +0.076/-0.076	4.763 +0.25/-0.25			BP00476-00635-00476-DP4	Bushes - Steel - DP4 - Split - Unflanged
4.763 +0.025/+0.050	6.350 +0.051/+0.076	5.334 +/-0.127			BP00476-00635-00533-BS	Bushes - Bronze - Sintered - Unflanged
4.763 +0.025/+0.050	6.350 +0.051/+0.076	6.172 +/-0.127			BP00476-00635-00617-BS	Bushes - Bronze - Sintered - Unflanged
4.762 +0.0254/+0.0508	6.350 +0.0508/+0.0762	6.350 +0.127/-0.127			BP00476-00635-00635-BS	Bushes - Bronze - Sintered - Unflanged
4.762 +0.0254/+0.0508	6.350 +0.0508/+0.0762	6.350 +0.127/-0.127			BP00476-00635-00635-BFG	Bushes - Bronze - Sintered - ECO841 Food Grade - Unflanged
4.762 -0.025/-0.043	6.350 +0.076/-0.076	6.350 +0.25/-0.25			BP00476-00635-00635-DP4	Bushes - Steel - DP4 - Split - Unflanged
4.762 -0.025/-0.043	6.350 +0.076/-0.076	6.350 +0.25/-0.25			BP00476-00635-00635-DU	Bushes - Steel - DU - Split - Unflanged
4.762 -0.025/-0.043	6.350 +0.076/-0.076	6.350 +0.25/-0.25			BP00476-00635-00635-SS6	Bushes - Stainless Steel and PTFE - Unflanged
4.763 +0.025/+0.050	6.350 +0.051/+0.076	7.747 +/-0.127			BP00476-00635-00775-BS	Bushes - Bronze - Sintered - Unflanged
4.763 +0.025/+0.050	6.350 +0.051/+0.076	8.382 +/-0.127			BP00476-00635-00838-BS	Bushes - Bronze - Sintered - Unflanged
4.763 +0.025/+0.050	6.350 +0.051/+0.076	8.712 +0/-0.152			BP00476-00635-00871-BS	Bushes - Bronze - Sintered - Unflanged
4.763 +0.013/-0.038	6.350 +0.051/+0.076	8.865 +0/-0.127	7.87	0.86	BF00476-00635-00887-BS	Bushes - Bronze - Sintered - Flanged
4.762 +0.0254/+0.0508	6.350 +0.0508/+0.0762	9.525 +0.127/-0.127			BP00476-00635-00953-BS	Bushes - Bronze - Sintered - Unflanged
4.762 -0.025/-0.043	6.350 +0.076/-0.076	9.525 +0.25/-0.25			BP00476-00635-00953-SS6	Bushes - Stainless Steel and PTFE - Unflanged
4.762 +0.0254/+0.0508	6.350 +0.0508/+0.0762	9.525 +0.127/-0.127			BP00476-00635-00953-BFG	Bushes - Bronze - Sintered - ECO841 Food Grade - Unflanged
4.762 -0.025/-0.043	6.350 +0.076/-0.076	9.525 +0.25/-0.25			BP00476-00635-00953-DU	Bushes - Steel - DU - Split - Unflanged
4.762 -0.025/-0.043	6.350 +0.076/-0.076	9.525 +0.25/-0.25			BP00476-00635-00953-DP4	Bushes - Steel - DP4 - Split - Unflanged
4.763 +0.025/+0.050	6.350 +0.051/+0.076	10.312 +/-0.127			BP00476-00635-01031-BS	Bushes - Bronze - Sintered - Unflanged
4.763 +0.025/+0.050	6.350 +0.051/+0.076	11.887 +/-0.127			BP00476-00635-01189-BS	Bushes - Bronze - Sintered - Unflanged
4.762 +0.0254/+0.0508	6.350 +0.0508/+0.0762	12.700 +0.127/-0.127			BP00476-00635-01270-BS	Bushes - Bronze - Sintered - Unflanged
4.762 +0.0254/+0.0508	6.350 +0.0508/+0.0762	12.700 +0.127/-0.127			BP00476-00635-01270-BFG	Bushes - Bronze - Sintered - ECO841 Food Grade - Unflanged
4.763 x 7.144 mm (0.188 x 0.281 in.)						
4.763 +0.025/+0.050	7.144 +0.045/+0.070	4.724 +0/-0.102			BP00476-00714-00472-BS	Bushes - Bronze - Sintered - Unflanged
4.763 +0/+0.025	7.144 +0.045/+0.070	5.537 +0/-0.152	96.14	1.45	BF00476-00714-00554-BS	Bushes - Bronze - Sintered - Flanged

 Stocked or Short Delivery

 Usually Available

 Long delivery or not in current production

ID	OD	B	DF	bf	Part Number	Type
4.763 x 7.144 mm (0.188 x 0.281 in.)						
4.763 +0.013/-0.038	7.144 +0.052/+0.077	7.137 +/-0.127	9.53	3.07	BF00476-00714-00714-BS	Bushes - Bronze - Sintered - Flanged
4.763 x 7.938 mm (0.188 x 0.313 in.)						
4.763 +0.025/+0.050	7.938 +0.026/+0.051	3.175 +/-0.127	9.53	1.19	BF00476-00794-00318-BS	Bushes - Bronze - Sintered - Flanged
4.763 +0/+0.025	7.938 +0.051/+0.076	3.416 +0/-0.203	11.11	1.57	BF00476-00794-00342-BS	Bushes - Bronze - Sintered - Flanged
4.763 +0.013/-0.038	7.938 +0.051/+0.076	6.096 +0/-0.152	9.53	2.21	BF00476-00794-00610-BS	Bushes - Bronze - Sintered - Flanged
4.763 +0.025/+0.050	7.938 +0.051/+0.076	6.325 +0/-0.102			BP00476-00794-00633-BS	Bushes - Bronze - Sintered - Unflanged
4.762 +0.0254/+0.0508	7.938 +0.0508/+0.0762	6.350 +0.127/-0.127			BP00476-00794-00635-BS	Bushes - Bronze - Sintered - Unflanged
4.763 +0.038/+0.063	7.938 +0.025/+0.050	6.350 +0.00/-0.51			BP00477-00794-00635-AF	Bushes - Aluminium - Frelon Lined - Unflanged
4.763 +0.005/+0.017	7.938 +0.023/+0.038	6.350 +/-0.110			BP00476-00794-00635-BSO	Bushes - Bronze - Sintered - Unflanged - Oilite
4.762 +0.0254/+0.0508	7.938 +0.0508/+0.0762	6.350 +0.127/-0.127			BP00476-00794-00635-BFG	Bushes - Bronze - Sintered - ECO841 Food Grade - Unflanged
4.763 +0.038/+0.063	7.938 +0.025/+0.050	6.350 +0.00/-0.51	11.10	1.59	BF00476-00794-00635-AF	Bushes - Aluminium - Frelon Lined - Flanged
4.763 +0.025/+0.051	7.938 +0.014/+0.039	6.350 +/-0.127	9.40	1.19	BF00476-00794-00635-BS05	Bushes - Bronze - Sintered - Flanged
4.763 +0.025/+0.050	7.938 +0.026/+0.051	6.350 +/-0.127	9.53	1.19	BF00476-00794-00635-BS06	Bushes - Bronze - Sintered - Flanged
4.763 +0.005/+0.017	7.938 +0.023/+0.038	6.350 +/-0.110	9.53	1.58	BF00476-00794-00635-BSO	Bushes - Bronze - Sintered - Flanged - Oilite
4.763 +0.005/+0.017	7.938 +0.023/+0.038	9.525 +/-0.110			BP00476-00794-00953-BSO	Bushes - Bronze - Sintered - Unflanged - Oilite
4.762 +0.0254/+0.0508	7.938 +0.0508/+0.0762	9.525 +0.127/-0.127			BP00476-00794-00953-BS	Bushes - Bronze - Sintered - Unflanged
4.762 +0.0254/+0.0508	7.938 +0.0508/+0.0762	9.525 +0.127/-0.127			BP00476-00794-00953-BFG	Bushes - Bronze - Sintered - ECO841 Food Grade - Unflanged
4.763 +0.051/+0.076	7.938 +0.025/-0.051	9.525 +/-0.127	11.11	1.59	BF00476-00794-00953-BS08	Bushes - Bronze - Sintered - Flanged
4.763 +0.025/+0.051	7.938 +0.014/+0.039	9.525 +/-0.127	9.40	1.19	BF00476-00794-00953-BS05	Bushes - Bronze - Sintered - Flanged
4.763 +0.005/+0.017	7.938 +0.023/+0.038	9.525 +/-0.110	9.53	1.58	BF00476-00794-00953-BSO	Bushes - Bronze - Sintered - Flanged - Oilite
4.763 +0.025/+0.051	7.938 +0.014/+0.039	12.700 +/-0.127			BP00476-00794-01270-BS05	Bushes - Bronze - Sintered - Unflanged
4.763 +0.025/+0.050	7.938 +0.051/+0.076	12.700 +/-0.127			BP00476-00794-01270-BS06	Bushes - Bronze - Sintered - Unflanged
4.763 +0.038/+0.063	7.938 +0.025/+0.050	12.700 +0.00/-0.51			BP00477-00794-01270-AF	Bushes - Aluminium - Frelon Lined - Unflanged
4.762 +0.0254/+0.0508	7.938 +0.0508/+0.0762	12.700 +0.127/-0.127			BP00476-00794-01270-BFG	Bushes - Bronze - Sintered - ECO841 Food Grade - Unflanged
4.763 +0.005/+0.017	7.938 +0.023/+0.038	12.700 +/-0.130			BP00476-00794-01270-BSO	Bushes - Bronze - Sintered - Unflanged - Oilite
4.763 +0.038/+0.063	7.938 +0.025/+0.050	12.700 +0.00/-0.51	11.10	1.59	BF00476-00794-01270-AF	Bushes - Aluminium - Frelon Lined - Flanged
4.763 +0.025/+0.051	7.938 +0.014/+0.039	12.700 +/-0.127	9.40	1.19	BF00476-00794-01270-BS	Bushes - Bronze - Sintered - Flanged
4.763 +0.005/+0.017	7.938 +0.023/+0.038	12.700 +/-0.130	9.53	1.58	BF00476-00794-01270-BSO	Bushes - Bronze - Sintered - Flanged - Oilite
4.763 +0.025/+0.051	7.938 +0.014/+0.039	15.875 +/-0.127			BP00476-00794-01588-BS	Bushes - Bronze - Sintered - Unflanged
4.763 +0.005/+0.017	7.938 +0.023/+0.038	15.875 +/-0.130			BP00476-00794-01588-BSO	Bushes - Bronze - Sintered - Unflanged - Oilite
4.763 +0.025/+0.051	7.938 +0.014/+0.039	15.875 +/-0.127	9.40	1.19	BF00476-00794-01588-BS	Bushes - Bronze - Sintered - Flanged
4.763 +0.025/-0	7.938 +0.025/-0.051	19.050 +/-0.127			BP00476-00794-01905-BS	Bushes - Bronze - Sintered - Unflanged
4.763 +0.005/+0.017	7.938 +0.023/+0.038	19.050 +/-0.160			BP00476-00794-01905-BSO	Bushes - Bronze - Sintered - Unflanged - Oilite
4.763 x 9.525 mm (0.188 x 0.375 in.)						
4.763 +0.010/-0	9.525 +0.003/-0.010	2.779 +0/-0.127	10.72	0.58	BF00476-00953-00278-BS	Bushes - Bronze - Sintered - Flanged
4.763 +0.010/-0	9.525 +0.003/-0.002	3.175 +0/-0.127			BP00476-00953-00318-BS	Bushes - Bronze - Sintered - Unflanged
4.763 +0.010/-0	9.525 +0.003/-0.010	3.175 +0/-0.127	10.72	0.58	BF00476-00953-00318-BSN	Bushes - Bronze - Sintered - Flanged
4.763 +0.010/-0	9.525 +0.003/-0.010	3.175 +0/-0.127	10.72	0.79	BF00476-00953-00318-BS	Bushes - Bronze - Sintered - Flanged
4.763 +0/+0.025	9.525 +0.039/+0.064	12.700 +/-0.127			BP00476-00953-01270-BS	Bushes - Bronze - Sintered - Unflanged

 Stocked or Short Delivery

 Usually Available

 Long delivery or not in current production

ID	OD	B	DF	bf	Part Number	Type
4.763 x 11.113 mm (0.188 x 0.438 in.)						
4.763 +0.025/+0.050	11.113 +0.052/+0.077	12.700 +/-0.127			BP00476-01111-01270-BS	Bushes - Bronze - Sintered - Unflanged
4.763 x 12.700 mm (0.188 x 0.500 in.)						
4.763 +0.010/-0	12.700 +0.003/-0.002	3.967 +0/-0.127			BP00476-01270-00397-BS	Bushes - Bronze - Sintered - Unflanged
4.763 +0.010/-0	12.700 +0.003/-0.010	3.967 +0/-0.127	14.35	1.07	BF00476-01270-00397-BS	Bushes - Bronze - Sintered - Flanged
4.763 +0.010/-0	12.700 +0.003/-0.002	4.978 +0/-0.127			BP00476-01270-00498-BS	Bushes - Bronze - Sintered - Unflanged
4.763 +0.010/-0	12.700 +0.003/-0.010	4.978 +0/-0.127	14.35	1.07	BF00476-01270-00498-BS	Bushes - Bronze - Sintered - Flanged
5.000 x 7.000 mm (0.197 x 0.276 in.)						
5.000 -0.000/-0.012	7.000 +0.015/-0.000	5.000 +0.25/-0.25			BP00500-00700-00500-DP4	Bushes - Steel - DP4 - Split - Unflanged
5.000 -0.000/-0.012	7.000 +0.015/-0.000	5.000 +0.25/-0.25			BP00500-00700-00500-DU	Bushes - Steel - DU - Split - Unflanged
5.000 -0.000/-0.012	7.000 +0.015/-0.000	5.000 +0.25/-0.25			BP00500-00700-00500-DUB	Bushes - Steel - DUB - Split - Unflanged
5.000 -0.000/-0.012	7.000 +0.015/-0.000	5.000 +0.25/-0.25	10.00	0.95	BF00500-00700-00500-DUB	Bushes - Steel - DUB - Split - Flanged
5.000 -0.000/-0.012	7.000 +0.015/-0.000	5.000 +0.25/-0.25	10.00	1.00	BF00500-00700-00500-DU	Bushes - Steel - DU - Split - Flanged
5.000 -0.000/-0.012	7.000 +0.015/-0.000	5.000 +0.25/-0.25	10.00	1.00	BF00500-00700-00500-DP4	Bushes - Steel - DP4 - Split - Flanged
5.000 -0.000/-0.012	7.000 +0.015/-0.000	8.000 +0.25/-0.25			BP00500-00700-00800-DU	Bushes - Steel - DU - Split - Unflanged
5.000 -0.000/-0.012	7.000 +0.015/-0.000	8.000 +0.25/-0.25			BP00500-00700-00800-DP4	Bushes - Steel - DP4 - Split - Unflanged
5.000 -0.000/-0.012	7.000 +0.015/-0.000	10.000 +0.25/-0.25			BP00500-00700-01000-DU	Bushes - Steel - DU - Split - Unflanged
5.000 -0.000/-0.012	7.000 +0.015/-0.000	10.000 +0.25/-0.25			BP00500-00700-01000-DP4	Bushes - Steel - DP4 - Split - Unflanged
5.000 -0.000/-0.012	7.000 +0.015/-0.000	10.000 +0.25/-0.25			BP00500-00700-01000-DUB	Bushes - Steel - DUB - Split - Unflanged
5.000 x 8.000 mm (0.197 x 0.315 in.)						
5.000 +0.020/+0.032	8.000 +0.019/+0.034	5.000 +0/-0.200			BP00500-00800-00500-BS	Bushes - Bronze - Sintered - Unflanged
5.000 +0.004/+0.016	8.000 +0.023/+0.038	5.000 +/-0.090			BP00500-00800-00500-BSO	Bushes - Bronze - Sintered - Unflanged - Oilite
5.000 +0.020/+0.032	8.000 +0.019/+0.034	6.000 +0/-0.200	10.00	2.00	BF00500-00800-00600-BS	Bushes - Bronze - Sintered - Flanged
5.000 +0.020/+0.032	8.000 +0.019/+0.034	8.000 +0/-0.200			BP00500-00800-00800-BS	Bushes - Bronze - Sintered - Unflanged
5.000 +0.004/+0.016	8.000 +0.023/+0.038	8.000 +/-0.110			BP00500-00800-00800-BSO	Bushes - Bronze - Sintered - Unflanged - Oilite
5.000 +0.004/+0.016	8.000 +0.023/+0.038	10.000 +/-0.110			BP00500-00800-01000-BSO	Bushes - Bronze - Sintered - Unflanged - Oilite
5.000 +0.004/+0.016	8.000 +0.023/+0.038	12.000 +/-0.130			BP00500-00800-01200-BSO	Bushes - Bronze - Sintered - Unflanged - Oilite
5.000 +0.004/+0.016	8.000 +0.023/+0.038	16.000 +/-0.130			BP00500-00800-01600-BSO	Bushes - Bronze - Sintered - Unflanged - Oilite
5.000 x 9.000 mm (0.197 x 0.354 in.)						
5.000 +0.004/+0.016	9.000 +0.023/+0.038	4.000 +/-0.090	13.00	2.00	BF00500-00900-00400-BSO	Bushes - Bronze - Sintered - Flanged - Oilite
5.000 +0.004/+0.016	9.000 +0.023/+0.038	5.000 +/-0.090			BP00500-00900-00500-BSO	Bushes - Bronze - Sintered - Unflanged - Oilite
5.000 +0.004/+0.016	9.000 +0.023/+0.038	5.000 +/-0.090	13.00	2.00	BF00500-00900-00500-BSO	Bushes - Bronze - Sintered - Flanged - Oilite
5.000 +0.004/+0.016	9.000 +0.023/+0.038	8.000 +/-0.110			BP00500-00900-00800-BSO	Bushes - Bronze - Sintered - Unflanged - Oilite
5.000 +0.004/+0.016	9.000 +0.023/+0.038	8.000 +/-0.110	13.00	2.00	BF00500-00900-00800-BSO	Bushes - Bronze - Sintered - Flanged - Oilite
5.000 x 10.000 mm (0.197 x 0.394 in.)						
5.000 +0.012/-0	10.000 +0/-0.009	5.000 +0/-0.170			BP00500-01000-00500-BS	Bushes - Bronze - Sintered - Unflanged
5.000 +0.012/-0	10.000 +0/-0.009	5.000 +0/-0.178	12.00	1.00	BF00500-01000-00500-BS	Bushes - Bronze - Sintered - Flanged
5.000 +0.020/+0.032	10.000 +0.019/+0.034	6.000 +0/-0.200	12.00	2.00	BF00500-01000-00600-BS	Bushes - Bronze - Sintered - Flanged
5.000 x 12.000 mm (0.197 x 0.472 in.)						
5.000 +0.012/-0	12.000 +0/-0.011	4.000 +0/-0.170			BP00500-01200-00400-BS	Bushes - Bronze - Sintered - Unflanged

 Stocked or Short Delivery

 Usually Available

 Long delivery or not in current production

ID	OD	B	DF	bf	Part Number	Type
5.000 x 12.000 mm (0.197 x 0.472 in.)						
5.000 +0.012/-0	12.000 +0/-0.011	4.000 +0/-0.178	14.00	1.00	BF00500-01200-00400-BS	Bushes - Bronze - Sintered - Flanged
5.000 x 13.000 mm (0.197 x 0.512 in.)						
5.000 +0.012/-0	13.000 +0/-0.011	5.000 +0/-0.170			BP00500-01300-00500-BS	Bushes - Bronze - Sintered - Unflanged
5.000 +0.012/-0	13.000 +0/-0.011	5.000 +0/-0.178	14.00	1.00	BF00500-01300-00500-BS	Bushes - Bronze - Sintered - Flanged
5.556 x 7.144 mm (0.219 x 0.281 in.)						
5.556 +0.025/-0	7.144 +0.007/+0.032	5.258 +0/-0.127	7.87	2.13	BF00556-00714-00526-BS	Bushes - Bronze - Sintered - Flanged
6.000 x 8.000 mm (0.236 x 0.315 in.)						
6.000 -0.000/-0.022	8.000 +0.055/-0.000	4.000 +0.25/-0.25			BP00600-00800-00400-DU	Bushes - Steel - DU - Split - Unflanged
6.000 -0.000/-0.022	8.000 +0.015/-0.000	4.000 +0.25/-0.25	12.00	0.95	BF00600-00800-00400-DUB	Bushes - Steel - DUB - Split - Flanged
6.000 -0.000/-0.022	8.000 +0.015/-0.000	4.000 +0.25/-0.25	12.00	1.00	BF00600-00800-00400-SS6	Bushes - Stainless Steel and PTFE - Flanged
6.000 -0.000/-0.012	8.000 +0.015/-0.000	4.000 +0.25/-0.25	12.00	1.00	BF00600-00800-00400-DP4	Bushes - Steel - DP4 - Split - Flanged
6.000 -0.000/-0.022	8.000 +0.015/-0.000	4.000 +0.25/-0.25	12.00	1.00	BF00600-00800-00400-DU	Bushes - Steel - DU - Split - Flanged
6.000 -0.000/-0.022	8.000 +0.055/-0.000	6.000 +0.25/-0.25			BP00600-00800-00600-DUB	Bushes - Steel - DUB - Split - Unflanged
6.000 -0.000/-0.022	8.000 +0.055/-0.000	6.000 +0.00/-0.30			BP00600-00800-00600-SS6	Bushes - Stainless Steel and PTFE - Unflanged
6.000 -0.000/-0.022	8.000 +0.055/-0.000	6.000 +0.25/-0.25			BP00600-00800-00600-DU	Bushes - Steel - DU - Split - Unflanged
6.000 -0.000/-0.012	8.000 +0.015/-0.000	6.000 +0.25/-0.25			BP00600-00800-00600-DP4	Bushes - Steel - DP4 - Split - Unflanged
6.000 -0.000/-0.022	8.000 +0.015/-0.000	7.000 +0.25/-0.25	12.00	1.00	BF00600-00800-00700-SS6	Bushes - Stainless Steel and PTFE - Flanged
6.000 -0.000/-0.022	8.000 +0.015/-0.000	7.000 +0.25/-0.25	12.00	1.00	BF00600-00800-00700-DU	Bushes - Steel - DU - Split - Flanged
6.000 -0.000/-0.012	8.000 +0.015/-0.000	7.000 +0.25/-0.25	12.00	1.00	BF00600-00800-00700-DP4	Bushes - Steel - DP4 - Split - Flanged
6.000 -0.000/-0.022	8.000 +0.055/-0.000	8.000 +0.25/-0.25			BP00600-00800-00800-DUB	Bushes - Steel - DUB - Split - Unflanged
6.000 -0.000/-0.012	8.000 +0.015/-0.000	8.000 +0.25/-0.25			BP00600-00800-00800-DP4	Bushes - Steel - DP4 - Split - Unflanged
6.000 -0.000/-0.022	8.000 +0.055/-0.000	8.000 +0.00/-0.30			BP00600-00800-00800-SS6	Bushes - Stainless Steel and PTFE - Unflanged
6.000 -0.000/-0.022	8.000 +0.055/-0.000	8.000 +0.25/-0.25			BP00600-00800-00800-DU	Bushes - Steel - DU - Split - Unflanged
6.000 -0.000/-0.012	8.000 +0.015/-0.000	8.000 +0.25/-0.25	12.00	1.00	BF00600-00800-00800-DP4	Bushes - Steel - DP4 - Split - Flanged
6.000 -0.000/-0.022	8.000 +0.015/-0.000	8.000 +0.25/-0.25	12.00	1.00	BF00600-00800-00800-DU	Bushes - Steel - DU - Split - Flanged
6.000 -0.000/-0.022	8.000 +0.055/-0.000	10.000 +0.00/-0.30			BP00600-00800-01000-SS6	Bushes - Stainless Steel and PTFE - Unflanged
6.000 -0.000/-0.022	8.000 +0.055/-0.000	10.000 +0.25/-0.25			BP00600-00800-01000-DUB	Bushes - Steel - DUB - Split - Unflanged
6.000 -0.000/-0.022	8.000 +0.055/-0.000	10.000 +0.25/-0.25			BP00600-00800-01000-DU	Bushes - Steel - DU - Split - Unflanged
6.000 -0.000/-0.012	8.000 +0.015/-0.000	10.000 +0.25/-0.25			BP00600-00800-01000-DP4	Bushes - Steel - DP4 - Split - Unflanged
6.000 x 9.000 mm (0.236 x 0.354 in.)						
6.000 +0.004/+0.016	9.000 +0.023/+0.038	4.000 +/-0.090			BP00600-00900-00400-BSO	Bushes - Bronze - Sintered - Unflanged - Oilite
6.000 +0.004/+0.016	9.000 +0.023/+0.038	6.000 +/-0.090			BP00600-00900-00600-BSO	Bushes - Bronze - Sintered - Unflanged - Oilite
6.000 +0.004/+0.016	9.000 +0.023/+0.038	10.000 +/-0.110			BP00600-00900-01000-BSO	Bushes - Bronze - Sintered - Unflanged - Oilite
6.000 +0.004/+0.016	9.000 +0.023/+0.038	10.000 +/-0.090	12.00	1.50	BF00600-00900-01000-BS	Bushes - Bronze - Sintered - Flanged
6.000 +0.004/+0.016	9.000 +0.023/+0.038	12.000 +/-0.130			BP00600-00900-01200-BSO	Bushes - Bronze - Sintered - Unflanged - Oilite
6.000 +0.004/+0.016	9.000 +0.023/+0.038	16.000 +/-0.130			BP00600-00900-01600-BSO	Bushes - Bronze - Sintered - Unflanged - Oilite
6.000 x 9.525 mm (0.236 x 0.375 in.)						
6.000 +0.025/+0.050	9.525 +0.051/+0.076	6.350 +/-0.127			BP00600-00953-00635-BS	Bushes - Bronze - Sintered - Unflanged

 Stocked or Short Delivery

 Usually Available

 Long delivery or not in current production

ID	OD	B	DF	bf	Part Number	Type
6.000 x 10.000 mm (0.236 x 0.394 in.)						
6.000 +0.020/+0.032	10.000 +0.019/+0.034	4.000 +0/-0.200			BP00600-01000-00400-BS	Bushes - Bronze - Sintered - Unflanged
6.000 +0.004/+0.016	10.000 +0.023/+0.038	4.000 +/-0.090			BP00600-01000-00400-BSO	Bushes - Bronze - Sintered - Unflanged - Oilite
6.000 +0.020/+0.032	10.000 +0.019/+0.034	4.000 +0/-0.200	14.00	2.00	BF00600-01000-00400-BS	Bushes - Bronze - Sintered - Flanged
6.000 +0.004/+0.016	10.000 +0.023/+0.038	4.000 +/-0.090	14.00	2.00	BF00600-01000-00400-BSO	Bushes - Bronze - Sintered - Flanged - Oilite
6.000 +0.012/-0	10.000 +0/-0.009	5.000 +0/-0.170			BP00600-01000-00500-BS	Bushes - Bronze - Sintered - Unflanged
6.000 +0.012/-0	10.000 +0/-0.009	5.000 +0/-0.178	12.00	1.00	BF00600-01000-00500-BS	Bushes - Bronze - Sintered - Flanged
6.000 +0.004/+0.016	10.000 +0.023/+0.038	6.000 +/-0.090			BP00600-01000-00600-BSO	Bushes - Bronze - Sintered - Unflanged - Oilite
6.000 +0.020/+0.032	10.000 +0.019/+0.034	6.000 +0/-0.200			BP00600-01000-00600-BS	Bushes - Bronze - Sintered - Unflanged
6.000 +0.020/+0.032	10.000 +0.019/+0.034	6.000 +0/-0.200	14.00	2.00	BF00600-01000-00600-BS	Bushes - Bronze - Sintered - Flanged
6.000 +0.004/+0.016	10.000 +0.023/+0.038	6.000 +/-0.090	14.00	2.00	BF00600-01000-00600-BSO	Bushes - Bronze - Sintered - Flanged - Oilite
6.000 +0.020/+0.032	10.000 +0.019/+0.034	10.000 +0/-0.200			BP00600-01000-01000-BS	Bushes - Bronze - Sintered - Unflanged
6.000 +0.004/+0.016	10.000 +0.023/+0.038	10.000 +/-0.110			BP00600-01000-01000-BSO	Bushes - Bronze - Sintered - Unflanged - Oilite
6.000 +0.004/+0.016	10.000 +0.023/+0.038	10.000 +/-0.110	14.00	2.00	BF00600-01000-01000-BSO	Bushes - Bronze - Sintered - Flanged - Oilite
6.000 x 12.000 mm (0.236 x 0.472 in.)						
6.000 +0.020/+0.032	12.000 +0.023/+0.041	6.000 +0/-0.200	14.00	2.00	BF00600-01200-00600-BS	Bushes - Bronze - Sintered - Flanged
6.000 +0.020/+0.032	12.000 +0.023/+0.041	8.000 +0/-0.200			BP00600-01200-00800-BS	Bushes - Bronze - Sintered - Unflanged
6.000 +0.020/+0.032	12.000 +0.023/+0.041	12.000 +0/-0.200			BP00600-01200-01200-BS	Bushes - Bronze - Sintered - Unflanged
6.000 x 16.000 mm (0.236 x 0.630 in.)						
6.000 +0.012/-0	16.000 +0/-0.011	5.000 +0/-0.170			BP00600-01600-00500-BS	Bushes - Bronze - Sintered - Unflanged
6.000 +0.012/-0	16.000 +0/-0.011	5.000 +0/-0.178	18.00	1.00	BF00600-01600-00500-BS	Bushes - Bronze - Sintered - Flanged
6.350 x 7.925 mm (0.250 x 0.312 in.)						
6.350 -0.025/-0.048	7.925 +0.076/-0.076	6.350 +0.25/-0.25			BP00635-00793-00635-SS6	Bushes - Stainless Steel and PTFE - Unflanged
6.350 -0.025/-0.048	7.925 +0.076/-0.076	6.350 +0.25/-0.25			BP00635-00793-00635-DU	Bushes - Steel - DU - Split - Unflanged
6.350 -0.025/-0.048	7.925 +0.076/-0.076	6.350 +0.25/-0.25			BP00635-00793-00635-DP4	Bushes - Steel - DP4 - Split - Unflanged
6.350 -0.025/-0.048	7.925 +0.076/-0.076	9.525 +0.25/-0.25			BP00635-00793-00953-DP4	Bushes - Steel - DP4 - Split - Unflanged
6.350 -0.025/-0.048	7.925 +0.076/-0.076	9.525 +0.25/-0.25			BP00635-00793-00953-DU	Bushes - Steel - DU - Split - Unflanged
6.350 -0.025/-0.048	7.925 +0.076/-0.076	9.525 +0.25/-0.25			BP00635-00793-00953-SS6	Bushes - Stainless Steel and PTFE - Unflanged
6.350 x 7.938 mm (0.250 x 0.313 in.)						
6.350 +0.025/+0.050	7.938 +0.051/+0.076	2.921 +/-0.127			BP00635-00794-00292-BS	Bushes - Bronze - Sintered - Unflanged
6.350 +0.013/-0.013	7.938 +0.063/+0.088	3.962 +/-0.127	11.11	1.65	BF00635-00794-00396-BS	Bushes - Bronze - Sintered - Flanged
6.350 +0.025/+0.050	7.938 +0.051/+0.076	4.293 +0/-0.152			BP00635-00794-00429-BS	Bushes - Bronze - Sintered - Unflanged
6.350 +0.025/+0.050	7.938 +0.051/+0.076	4.750 +/-0.127			BP00635-00794-00475-BS	Bushes - Bronze - Sintered - Unflanged
6.350 +0.025/+0.050	7.938 +0.051/+0.076	5.944 +/-0.127			BP00635-00794-00594-BS	Bushes - Bronze - Sintered - Unflanged
6.350 +0.025/+0.050	7.938 +0.051/+0.076	6.350 +/-0.127			BP00635-00794-00635-BS	Bushes - Bronze - Sintered - Unflanged
6.350 +0.0254/+0.0508	7.938 +0.0508/+0.0762	6.350 +0.127/-0.127			BP00635-00794-00635-BFG	Bushes - Bronze - Sintered - ECO841 Food Grade - Unflanged
6.350 +0.025/+0.051	7.938 +0.063/+0.088	6.350 +/-0.127	11.11	1.65	BF00635-00794-00635-BS	Bushes - Bronze - Sintered - Flanged
6.350 +0.025/+0.050	7.938 +0.051/+0.076	8.839 +/-0.127			BP00635-00794-00884-BS	Bushes - Bronze - Sintered - Unflanged
6.350 +0.025/+0.050	7.938 +0.051/+0.076	9.906 +/-0.127			BP00635-00794-00991-BS	Bushes - Bronze - Sintered - Unflanged
6.350 +0.025/+0.050	7.938 +0.051/+0.076	11.100 +/-0.127			BP00635-00794-01110-BS	Bushes - Bronze - Sintered - Unflanged

Stocked or Short Delivery

Usually Available

Long delivery or not in current production

ID	OD	B	DF	bf	Part Number	Type
6.350 x 7.938 mm (0.250 x 0.313 in.)						
6.350 -0.025/-0.048	7.938 +0.076/+0.076	12.700 +0.25/-0.25			BP00635-00794-01270-DU	Bushes - Steel - DU - Split - Unflanged
6.350 +0.025/+0.050	7.938 +0.051/+0.076	12.700 +/-0.127			BP00635-00794-01270-BS	Bushes - Bronze - Sintered - Unflanged
6.350 +0.0254/+0.0508	7.938 +0.0508/+0.0762	12.700 +0.127/-0.127			BP00635-00794-01270-BFG	Bushes - Bronze - Sintered - ECO841 Food Grade - Unflanged
6.350 +0.025/+0.051	7.938 +0.051/+0.076	12.700 +/-0.127	11.11	1.68	BF00635-00794-01270-BS	Bushes - Bronze - Sintered - Flanged
6.350 +0.025/-0	7.938 +0.025/+0.076	19.050 +/-0.397			BP00635-00794-01905-BS	Bushes - Bronze - Sintered - Unflanged
6.350 +0.0254/+0.0508	7.938 +0.0508/+0.0762	19.050 +0.127/-0.127			BP00635-00801-01905-BS	Bushes - Bronze - Sintered - Unflanged
6.350 +0.0254/+0.0508	7.938 +0.0508/+0.0762	19.050 +0.127/-0.127			BP00635-00794-01905-BFG	Bushes - Bronze - Sintered - ECO841 Food Grade - Unflanged
6.350 x 9.525 mm (0.250 x 0.375 in.)						
6.350 +0.010/-0	9.525 +0.003/-0.002	3.175 +0/-0.127			BP00635-00953-00318-BS	Bushes - Bronze - Sintered - Unflanged
6.350 +0.010/-0	9.525 +0.003/-0.010	3.175 +0/-0.127	10.72	0.58	BF00635-00953-00318-BSN	Bushes - Bronze - Sintered - Flanged
6.350 +0.010/-0	9.525 +0.003/-0.010	3.175 +0/-0.127	10.72	0.91	BF00635-00953-00318-BS	Bushes - Bronze - Sintered - Flanged
6.350 +0.025/+0.050	9.525 +0.051/+0.076	5.537 +/-0.127			BP00635-00953-00554-BS	Bushes - Bronze - Sintered - Unflanged
6.350 +0.038/+0.063	9.525 +0.025/+0.050	6.350 +0.00/-0.51			BP00635-00953-00635-AF	Bushes - Aluminium - Frelon Lined - Unflanged
6.350 +0.0254/+0.0508	9.525 +0.0508/+0.0762	6.350 +0.127/-0.127			BP00635-00953-00635-BS	Bushes - Bronze - Sintered - Unflanged
6.350 +0.0254/+0.0508	9.525 +0.0508/+0.0762	6.350 +0.127/-0.127			BP00635-00953-00635-BFG	Bushes - Bronze - Sintered - ECO841 Food Grade - Unflanged
6.350 +0.005/+0.020	9.525 +0.023/+0.038	6.350 +/-0.110			BP00635-00953-00635-BSO	Bushes - Bronze - Sintered - Unflanged - Oilite
6.350 +0.025/+0.050	9.525 +0.026/+0.051	6.350 +/-0.127	12.70	1.19	BF00635-00953-00635-BS05	Bushes - Bronze - Sintered - Flanged
6.350 +0.005/+0.020	9.525 +0.023/+0.038	6.350 +/-0.110	12.70	1.58	BF00635-00953-00635-BSO	Bushes - Bronze - Sintered - Flanged - Oilite
6.350 +0.038/+0.063	9.525 +0.025/+0.050	6.350 +0.00/-0.51	12.70	1.59	BF00635-00953-00635-AF	Bushes - Aluminium - Frelon Lined - Flanged
6.350 +0/-0.025	9.525 +0.127/+0.152	6.350 +/-0.127	12.70	1.59	BF00635-00953-00635-BS00	Bushes - Bronze - Sintered - Flanged
6.350 +0.025/+0.050	9.525 +0.051/+0.076	7.518 +/-0.127			BP00635-00953-00752-BS	Bushes - Bronze - Sintered - Unflanged
6.350 +0.025/+0.050	9.525 +0.051/+0.076	7.925 +/-0.127			BP00635-00953-00793-BS	Bushes - Bronze - Sintered - Unflanged
6.350 +0.0254/+0.0508	9.525 +0.0508/+0.0762	9.525 +0.127/-0.127			BP00635-00953-00953-BS	Bushes - Bronze - Sintered - Unflanged
6.350 +0.038/+0.063	9.525 +0.025/+0.050	9.525 +0.00/-0.51			BP00635-00953-00953-AF	Bushes - Aluminium - Frelon Lined - Unflanged
6.350 +0.0254/+0.0508	9.525 +0.0508/+0.0762	9.525 +0.127/-0.127			BP00635-00953-00953-BFG	Bushes - Bronze - Sintered - ECO841 Food Grade - Unflanged
6.350 +0.005/+0.020	9.525 +0.023/+0.038	9.525 +/-0.110			BP00635-00953-00953-BSO	Bushes - Bronze - Sintered - Unflanged - Oilite
6.350 +/-0.0254	9.525 +0.0508/+0.0762	9.525 +/-0.127			BP00635-00953-00953-BC9	Bushes - Bronze - Solid - Leaded Gunmetal
6.350 +0.051/+0.076	9.525 +0.025/-0.051	9.525 +/-0.127	11.91	1.59	BF00635-00953-00953-BS08	Bushes - Bronze - Sintered - Flanged
6.350 +0.025/+0.050	9.525 +0.026/+0.051	9.525 +/-0.127	12.70	1.19	BF00635-00953-00953-BS05	Bushes - Bronze - Sintered - Flanged
6.350 +0.005/+0.020	9.525 +0.023/+0.038	9.525 +/-0.110	12.70	1.58	BF00635-00953-00953-BSO	Bushes - Bronze - Sintered - Flanged - Oilite
6.350 +0.038/+0.063	9.525 +0.025/+0.050	9.525 +0.00/-0.51	12.70	1.59	BF00635-00953-00953-AF	Bushes - Aluminium - Frelon Lined - Flanged
6.350 +0.025/+0.050	9.525 +0.051/+0.076	10.312 +/-0.127			BP00635-00953-01031-BS	Bushes - Bronze - Sintered - Unflanged
6.350 +0.025/+0.051	9.525 +0.077/+0.102	10.312 +/-0.127	12.70	2.41	BF00635-00953-01031-BS	Bushes - Bronze - Sintered - Flanged
6.350 +0.038/+0.063	9.525 +0.025/+0.050	12.700 +0.00/-0.51			BP00635-00953-01270-AF	Bushes - Aluminium - Frelon Lined - Unflanged
6.350 +0.025/+0.050	9.525 +0.051/+0.076	12.700 +/-0.127			BP00635-00953-01270-BS06	Bushes - Bronze - Sintered - Unflanged
6.350 +0.025/+0.051	9.525 +0.026/+0.051	12.700 +/-0.127			BP00635-00953-01270-BS05	Bushes - Bronze - Sintered - Unflanged
6.350 +0.0254/+0.0508	9.525 +0.0508/+0.0762	12.700 +0.127/-0.127			BP00635-00953-01270-BFG	Bushes - Bronze - Sintered - ECO841 Food Grade - Unflanged
6.350 +0.005/+0.020	9.525 +0.023/+0.038	12.700 +/-0.130			BP00635-00953-01270-BSO	Bushes - Bronze - Sintered - Unflanged - Oilite
6.350 +/-0.0254	9.525 +0.0508/+0.0762	12.700 +/-0.127			BP00635-00953-01270-BC9	Bushes - Bronze - Solid - Leaded Gunmetal

Stocked or Short Delivery

Usually Available

Long delivery or not in current production

ID	OD	B	DF	bf	Part Number	Type
6.350 x 9.525 mm (0.250 x 0.375 in.)						
6.350 +0.025/+0.050	9.525 +0.026/+0.051	12.700 +/-0.127	12.70	1.19	BF00635-00953-01270-BS	Bushes - Bronze - Sintered - Flanged
6.350 +0.005/+0.020	9.525 +0.023/+0.038	12.700 +/-0.130	12.70	1.58	BF00635-00953-01270-BSO	Bushes - Bronze - Sintered - Flanged - Oilite
6.350 +0.038/+0.063	9.525 +0.025/+0.050	12.700 +0.00/-0.51	12.70	1.59	BF00635-00953-01270-AF	Bushes - Aluminium - Frelon Lined - Flanged
6.350 +0.025/+0.050	9.525 +0.051/+0.076	14.478 +0/-0.152			BP00635-00953-01448-BS	Bushes - Bronze - Sintered - Unflanged
6.350 +0.025/+0.051	9.525 +0.077/+0.102	14.681 +0/-0.127	12.70	2.41	BF00635-00953-01468-BS	Bushes - Bronze - Sintered - Flanged
6.350 +0.005/+0.020	9.525 +0.023/+0.038	15.875 +/-0.130			BP00635-00953-01588-BSO	Bushes - Bronze - Sintered - Unflanged - Oilite
6.350 +0.0254/+0.0508	9.525 +0.0508/+0.0762	15.875 +0.127/-0.127			BP00635-00953-01588-BS	Bushes - Bronze - Sintered - Unflanged
6.350 +0.0254/+0.0508	9.525 +0.0508/+0.0762	15.875 +0.127/-0.127			BP00635-00953-01588-BFG	Bushes - Bronze - Sintered - ECO841 Food Grade - Unflanged
6.350 +0.025/+0.050	9.525 +0.026/+0.051	15.875 +/-0.127	12.70	1.19	BF00635-00953-01588-BS	Bushes - Bronze - Sintered - Flanged
6.350 +0.025/+0.050	9.525 +0.051/+0.076	18.263 +/-0.127			BP00635-00953-01826-BS	Bushes - Bronze - Sintered - Unflanged
6.350 +0.0254/+0.0508	9.525 +0.0508/+0.0762	19.050 +0.127/-0.127			BP00635-00953-01905-BS	Bushes - Bronze - Sintered - Unflanged
6.350 +0.0254/+0.0508	9.525 +0.0508/+0.0762	19.050 +0.127/-0.127			BP00635-00953-01905-BFG	Bushes - Bronze - Sintered - ECO841 Food Grade - Unflanged
6.350 +0.005/+0.020	9.525 +0.023/+0.038	19.050 +/-0.160			BP00635-00953-01905-BSO	Bushes - Bronze - Sintered - Unflanged - Oilite
6.350 +/-0.0254	9.525 +0.0508/+0.0762	19.050 +/-0.127			BP00635-00953-01905-BC9	Bushes - Bronze - Solid - Leaded Gunmetal
6.350 +0.025/+0.050	9.525 +0.026/+0.051	19.050 +/-0.127	12.70	1.19	BF00635-00953-01905-BS	Bushes - Bronze - Sintered - Flanged
6.350 +0.005/+0.020	9.525 +0.023/+0.038	19.050 +/-0.160	12.70	1.58	BF00635-00953-01905-BSO	Bushes - Bronze - Sintered - Flanged - Oilite
6.350 +0.0254/+0.0508	9.525 +0.0508/+0.0762	22.225 +0.127/-0.127			BP00635-00953-02223-BS	Bushes - Bronze - Sintered - Unflanged
6.350 +0.0254/+0.0508	9.525 +0.0508/+0.0762	22.225 +0.127/-0.127			BP00635-00953-02223-BFG	Bushes - Bronze - Sintered - ECO841 Food Grade - Unflanged
6.350 +0.025/-0	9.525 +0.025/+0.076	25.400 +/-0.397			BP00635-00953-02540-BS	Bushes - Bronze - Sintered - Unflanged
6.350 +0.0254/+0.0508	9.525 +0.0508/+0.0762	25.400 +0.127/-0.127			BP00635-00960-02540-BS	Bushes - Bronze - Sintered - Unflanged
6.350 +0.0254/+0.0508	9.525 +0.0508/+0.0762	25.400 +0.127/-0.127			BP00635-00953-02540-BFG	Bushes - Bronze - Sintered - ECO841 Food Grade - Unflanged
6.350 +/-0.0254	9.525 +0.0508/+0.0762	25.400 +/-0.127			BP00635-00953-02540-BC9	Bushes - Bronze - Solid - Leaded Gunmetal
6.350 +/-0.013	9.525 +0.026/+0.051	31.750 +/-0.127			BP00635-00953-03175-BS	Bushes - Bronze - Sintered - Unflanged
6.350 +/-0.0254	9.525 +0.0508/+0.0762	31.750 +/-0.127			BP00635-00953-03175-BC9	Bushes - Bronze - Solid - Leaded Gunmetal
6.350 x 11.113 mm (0.250 x 0.438 in.)						
6.350 +0.025/+0.050	11.113 +0.052/+0.077	10.338 +/-0.127			BP00635-01111-01034-BS	Bushes - Bronze - Sintered - Unflanged
6.350 +0.025/+0.050	11.113 +0.052/+0.077	11.100 +/-0.127			BP00635-01111-01110-BS	Bushes - Bronze - Sintered - Unflanged
6.350 x 12.700 mm (0.250 x 0.500 in.)						
6.350 +0.010/-0	12.700 +0.003/-0.002	3.175 +0/-0.127			BP00635-01270-00318-BS	Bushes - Bronze - Sintered - Unflanged
6.350 +0.010/-0	12.700 +0.003/-0.010	3.175 +0/-0.127	13.89	0.58	BF00635-01270-00318-BS	Bushes - Bronze - Sintered - Flanged
6.350 +0.010/-0	12.700 +0.003/-0.002	4.763 +0/-0.127			BP00635-01270-00476-BS	Bushes - Bronze - Sintered - Unflanged
6.350 +0.010/-0	12.700 +0.003/-0.010	4.763 +0/-0.127	13.89	1.14	BF00635-01270-00476-BS	Bushes - Bronze - Sintered - Flanged
6.350 +0.025/-0	12.700 +0.051/+0.076	5.537 +/-0.127			BP00635-01270-00554-BS	Bushes - Bronze - Sintered - Unflanged
6.350 +0.0254/+0.0508	12.700 +0.0508/+0.0762	12.700 +0.127/-0.127			BP00635-01270-01270-BS	Bushes - Bronze - Sintered - Unflanged
6.350 +0.0254/+0.0508	12.700 +0.0508/+0.0762	12.700 +0.127/-0.127			BP00635-01270-01270-BFG	Bushes - Bronze - Sintered - ECO841 Food Grade - Unflanged
6.350 +0.0254/+0.0508	12.700 +0.0508/+0.0762	19.050 +0.127/-0.127			BP00635-01270-01905-BS	Bushes - Bronze - Sintered - Unflanged
6.350 +0.0254/+0.0508	12.700 +0.0508/+0.0762	19.050 +0.127/-0.127			BP00635-01270-01905-BFG	Bushes - Bronze - Sintered - ECO841 Food Grade - Unflanged
6.350 +0.0254/+0.0508	12.700 +0.0508/+0.0762	25.400 +0.127/-0.127			BP00635-01270-02540-BS	Bushes - Bronze - Sintered - Unflanged

 Stocked or Short Delivery

 Usually Available

 Long delivery or not in current production

ID	OD	B	DF	bf	Part Number	Type
6.350 x 12.700 mm (0.250 x 0.500 in.)						
6.350 +0.0254/+0.0508	12.700 +0.0508/+0.0762	25.400 +0.127/-0.127			BP00635-01270-02540-BFG	Bushes - Bronze - Sintered - ECO841 Food Grade - Unflanged
6.350 x 15.875 mm (0.250 x 0.625 in.)						
6.350 +0.010/-0	15.875 +0.003/-0.002	4.978 +0/-0.127			BP00635-01588-00498-BS	Bushes - Bronze - Sintered - Unflanged
6.350 +0.010/-0	15.875 +0.003/-0.010	4.978 +0/-0.127	17.53	1.07	BF00635-01588-00498-BS	Bushes - Bronze - Sintered - Flanged
7.000 x 9.000 mm (0.276 x 0.354 in.)						
7.000 -0.000/+0.015	9.000 +0.015/-0.000	5.000 +0.25/-0.25			BP00700-00900-00500-DU	Bushes - Steel - DU - Split - Unflanged
7.000 -0.000/+0.015	9.000 +0.015/-0.000	10.000 +0.25/-0.25			BP00700-00900-01000-DU	Bushes - Steel - DU - Split - Unflanged
7.000 -0.000/+0.015	9.000 +0.015/-0.000	10.000 +0.25/-0.25			BP00700-00900-01000-DP4	Bushes - Steel - DP4 - Split - Unflanged
7.000 x 10.000 mm (0.276 x 0.394 in.)						
7.000 +0.005/+0.020	10.000 +0.023/+0.038	5.000 +/-0.090			BP00700-01000-00500-BSO	Bushes - Bronze - Sintered - Unflanged - Oilite
7.000 +0.025/+0.040	10.000 +0.019/+0.034	8.000 +0/-0.200			BP00700-01000-00800-BS	Bushes - Bronze - Sintered - Unflanged
7.000 +0.005/+0.020	10.000 +0.023/+0.038	8.000 +/-0.110			BP00700-01000-00800-BSO	Bushes - Bronze - Sintered - Unflanged - Oilite
7.000 +0.025/+0.040	10.000 +0.019/+0.034	10.000 +0/-0.200			BP00700-01000-01000-BS	Bushes - Bronze - Sintered - Unflanged
7.000 +0.005/+0.020	10.000 +0.023/+0.038	10.000 +/-0.110			BP00700-01000-01000-BSO	Bushes - Bronze - Sintered - Unflanged - Oilite
7.000 x 11.000 mm (0.276 x 0.433 in.)						
7.000 +0.005/+0.020	11.000 +0.028/+0.046	8.000 +/-0.110			BP00700-01100-00800-BSO	Bushes - Bronze - Sintered - Unflanged - Oilite
7.000 +0.005/+0.020	11.000 +0.028/+0.046	8.000 +/-0.110	15.00	2.00	BF00700-01100-00800-BSO	Bushes - Bronze - Sintered - Flanged - Oilite
7.000 +0.005/+0.020	11.000 +0.028/+0.046	10.000 +/-0.110			BP00700-01100-01000-BSO	Bushes - Bronze - Sintered - Unflanged - Oilite
7.000 x 12.000 mm (0.276 x 0.472 in.)						
7.000 +0.025/+0.040	12.000 +0.023/+0.041	8.000 +0/-0.200	16.00	3.00	BF00700-01200-00800-BS	Bushes - Bronze - Sintered - Flanged
7.144 x 9.525 mm (0.281 x 0.375 in.)						
7.144 +0/+0.025	9.525 +0.077/+0.102	5.558 +/-0.127	12.70	2.41	BF00714-00953-00556-BS	Bushes - Bronze - Sintered - Flanged
7.541 x 9.525 mm (0.297 x 0.375 in.)						
7.541 +0.025/+0.050	9.525 +0.051/+0.076	5.715 +/-0.127			BP00754-00953-00572-BS	Bushes - Bronze - Sintered - Unflanged
7.925 x 9.525 mm (0.312 x 0.375 in.)						
7.925 -0.025/-0.048	9.525 +0.076/-0.076	9.525 +0.25/-0.25			BP00793-00953-00953-DP4	Bushes - Steel - DP4 - Split - Unflanged
7.925 -0.025/-0.048	9.525 +0.076/-0.076	9.525 +0.25/-0.25			BP00793-00953-00953-DU	Bushes - Steel - DU - Split - Unflanged
7.925 -0.025/-0.048	9.525 +0.076/-0.076	9.525 +0.25/-0.25			BP00793-00953-00953-SS6	Bushes - Stainless Steel and PTFE - Unflanged
7.925 -0.025/-0.048	9.525 +0.076/-0.076	12.700 +0.25/-0.25			BP00793-00953-01270-DP4	Bushes - Steel - DP4 - Split - Unflanged
7.925 -0.025/-0.048	9.525 +0.076/-0.076	12.700 +0.25/-0.25			BP00793-00953-01270-DU	Bushes - Steel - DU - Split - Unflanged
7.925 -0.025/-0.048	9.525 +0.076/-0.076	12.700 +0.25/-0.25			BP00793-00953-01270-SS6	Bushes - Stainless Steel and PTFE - Unflanged
7.938 x 9.525 mm (0.313 x 0.375 in.)						
7.938 +0.025/+0.050	9.525 +0.051/+0.076	3.175 +/-0.127			BP00794-00953-00318-BS	Bushes - Bronze - Sintered - Unflanged
7.938 +0.025/+0.050	9.525 +0.051/+0.076	5.283 +/-0.127			BP00794-00953-00528-BS	Bushes - Bronze - Sintered - Unflanged
7.938 +0.025/-0	9.525 +0.051/+0.076	6.350 +/-0.127			BP00794-00953-00635-BS	Bushes - Bronze - Sintered - Unflanged
7.938 +0.0254/+0.0508	9.525 +0.0508/+0.0762	6.350 +0.127/-0.127			BP00794-00953-00635-BFG	Bushes - Bronze - Sintered - ECO841 Food Grade - Unflanged
7.938 +0.025/+0.050	9.525 +0.051/+0.076	7.137 +/-0.127			BP00794-00953-00714-BS	Bushes - Bronze - Sintered - Unflanged

 Stocked or Short Delivery

 Usually Available

 Long delivery or not in current production

ID	OD	B	DF	bf	Part Number	Type
7.938 x 9.525 mm (0.313 x 0.375 in.)						
7.938 +0.025/+0.050	9.525 +0.051/+0.076	9.398 +/-0.127			BP00794-00953-00940-BS	Bushes - Bronze - Sintered - Unflanged
7.938 +0.0254/+0.0508	9.525 +0.0508/+0.0762	9.525 +0.127/-0.127			BP00794-00953-00953-BS	Bushes - Bronze - Sintered - Unflanged
7.938 +0.0254/+0.0508	9.525 +0.0508/+0.0762	9.525 +0.127/-0.127			BP00794-00953-00953-BFG	Bushes - Bronze - Sintered - ECO841 Food Grade - Unflanged
7.938 +0.025/+0.050	9.525 +0.026/+0.051	9.525 +/-0.127	12.70	1.19	BF00794-00953-00953-BS	Bushes - Bronze - Sintered - Flanged
7.938 +0.025/+0.050	9.525 +0.051/+0.076	10.693 +/-0.127			BP00794-00953-01069-BS	Bushes - Bronze - Sintered - Unflanged
7.938 +0.025/+0.050	9.525 +0.051/+0.076	12.370 +/-0.127			BP00794-00953-01237-BS	Bushes - Bronze - Sintered - Unflanged
7.938 +0.0254/+0.0508	9.525 +0.0508/+0.0762	12.700 +0.127/-0.127			BP00794-00953-01270-BS	Bushes - Bronze - Sintered - Unflanged
7.938 +0.0254/+0.0508	9.525 +0.0508/+0.0762	12.700 +0.127/-0.127			BP00794-00953-01270-BFG	Bushes - Bronze - Sintered - ECO841 Food Grade - Unflanged
7.938 +0.0254/+0.0508	9.525 +0.0508/+0.0762	15.875 +0.127/-0.127			BP00794-00953-01588-BS	Bushes - Bronze - Sintered - Unflanged
7.938 +0.0254/+0.0508	9.525 +0.0508/+0.0762	15.875 +0.127/-0.127			BP00794-00953-01588-BFG	Bushes - Bronze - Sintered - ECO841 Food Grade - Unflanged
7.938 +0.0254/+0.0508	9.525 +0.0508/+0.0762	19.050 +0.127/-0.127			BP00794-00953-01905-BS	Bushes - Bronze - Sintered - Unflanged
7.938 +0.0254/+0.0508	9.525 +0.0508/+0.0762	19.050 +0.127/-0.127			BP00794-00953-01905-BFG	Bushes - Bronze - Sintered - ECO841 Food Grade - Unflanged
7.938 x 11.113 mm (0.313 x 0.438 in.)						
7.938 +0.025/+0.050	11.113 +0.052/+0.077	4.750 +/-0.127			BP00794-01111-00475-BS	Bushes - Bronze - Sintered - Unflanged
7.938 +0/-0.025	11.113 +0.039/+0.064	9.525 +/-0.127	14.29	1.59	BF00794-01111-00953-BS00	Bushes - Bronze - Sintered - Flanged
7.938 +0.025/+0.050	11.113 +0.014/+0.039	9.525 +/-0.127	15.88	2.38	BF00794-01111-00953-BS05	Bushes - Bronze - Sintered - Flanged
7.938 +0/+0.025	11.113 +0.026/+0.051	15.875 +/-0.127			BP00794-01111-01588-BS	Bushes - Bronze - Sintered - Unflanged
7.938 +/-0.0254	11.113 +0.0508/+0.0762	19.050 +/-0.127			BP00794-01111-01905-BLG	Bushes - Bronze - Solid - Leaded Gunmetal
7.938 +0.025/+0.050	11.113 +0.014/+0.039	19.050 +/-0.127	15.88	2.38	BF00794-01111-01905-BS	Bushes - Bronze - Sintered - Flanged
7.938 +/-0.0254	11.113 +0.0508/+0.0762	25.400 +/-0.127			BP00794-01111-02540-BLG	Bushes - Bronze - Solid - Leaded Gunmetal
7.938 x 12.700 mm (0.313 x 0.500 in.)						
7.938 +0.005/+0.020	12.700 +0.028/+0.046	6.350 +/-0.110			BP00794-01270-00635-BSO	Bushes - Bronze - Sintered - Unflanged - Oilite
7.938 +0.005/+0.020	12.700 +0.028/+0.046	6.350 +/-0.110	15.88	1.58	BF00794-01270-00635-BSO	Bushes - Bronze - Sintered - Flanged - Oilite
7.938 +0.025/+0.050	12.700 +0.051/+0.076	7.925 +/-0.127			BP00794-01270-00793-BS	Bushes - Bronze - Sintered - Unflanged
7.938 +0.005/+0.020	12.700 +0.028/+0.046	9.525 +/-0.110			BP00794-01270-00953-BSO	Bushes - Bronze - Sintered - Unflanged - Oilite
7.938 +0.005/+0.020	12.700 +0.028/+0.046	9.525 +/-0.110	15.88	1.58	BF00794-01270-00953-BSO	Bushes - Bronze - Sintered - Flanged - Oilite
7.938 +0.025/+0.050	12.700 +0.026/+0.051	9.525 +/-0.127	17.46	2.38	BF00794-01270-00953-BS	Bushes - Bronze - Sintered - Flanged
7.938 +0.025/+0.050	12.700 +0.051/+0.076	11.100 +/-0.127			BP00794-01270-01110-BS	Bushes - Bronze - Sintered - Unflanged
7.938 +0.025/-0	12.700 +0.077/+0.102	12.314 +/-0.127	14.27	1.65	BF00794-01270-01231-BS	Bushes - Bronze - Sintered - Flanged
7.938 +0.005/+0.020	12.700 +0.028/+0.046	12.700 +/-0.130			BP00794-01270-01270-BSO	Bushes - Bronze - Sintered - Unflanged - Oilite
7.938 +0.005/+0.020	12.700 +0.028/+0.046	12.700 +/-0.130	15.88	1.58	BF00794-01270-01270-BSO	Bushes - Bronze - Sintered - Flanged - Oilite
7.938 +0.025/+0.050	12.700 +0.026/+0.051	12.700 +/-0.127	17.46	2.38	BF00794-01270-01270-BS	Bushes - Bronze - Sintered - Flanged
7.938 +0.005/+0.020	12.700 +0.028/+0.046	15.875 +/-0.130			BP00794-01270-01588-BSO	Bushes - Bronze - Sintered - Unflanged - Oilite
7.938 +0.025/+0.050	12.700 +0.026/+0.051	15.875 +/-0.127	17.46	2.38	BF00794-01270-01588-BS	Bushes - Bronze - Sintered - Flanged
7.938 +0.025/+0.050	12.700 +0.051/+0.076	17.856 +/-0.127			BP00794-01270-01786-BS	Bushes - Bronze - Sintered - Unflanged
7.938 +0.005/+0.020	12.700 +0.028/+0.046	19.050 +/-0.160			BP00794-01270-01905-BSO	Bushes - Bronze - Sintered - Unflanged - Oilite
7.938 +0.038/-0.013	12.700 +0.025/-0.051	19.050 +/-0.127			BP00794-01270-01905-BS	Bushes - Bronze - Sintered - Unflanged
7.938 +/-0.0254	12.700 +0.0508/+0.0762	19.050 +/-0.127			BP00794-01270-01905-BC9	Bushes - Bronze - Solid - Leaded Gunmetal
7.938 +0.005/+0.020	12.700 +0.028/+0.046	19.050 +/-0.160	15.88	1.58	BF00794-01270-01905-BSO	Bushes - Bronze - Sintered - Flanged - Oilite

 Stocked or Short Delivery

 Usually Available

 Long delivery or not in current production

ID	OD	B	DF	bf	Part Number	Type
7.938 x 12.700 mm (0.313 x 0.500 in.)						
7.938 +0.025/+0.050	12.700 +0.051/+0.076	25.400 +/-0.127			BP00794-01270-02540-BS	Bushes - Bronze - Sintered - Unflanged
7.938 +/-0.0254	12.700 +0.0508/+0.0762	25.400 +/-0.127			BP00794-01270-02540-BC9	Bushes - Bronze - Solid - Leaded Gunmetal
7.938 +/-0.0254	12.700 +0.0508/+0.0762	31.750 +/-0.127			BP00794-01270-03175-BC9	Bushes - Bronze - Solid - Leaded Gunmetal
7.938 x 17.463 mm (0.313 x 0.688 in.)						
7.938 +0.010/-0	17.463 +0.003/-0.002	6.350 +0/-0.127			BP00794-01746-00635-BS	Bushes - Bronze - Sintered - Unflanged
7.938 +0.010/-0	17.463 +0.003/-0.010	6.350 +0/-0.127	19.05	1.07	BF00794-01746-00635-BS	Bushes - Bronze - Sintered - Flanged
8.000 x 10.000 mm (0.315 x 0.394 in.)						
8.000 -0.000/-0.028	10.000 +0.015/-0.000	5.500 +0.25/-0.25	15.00	0.95	BF00800-01000-00550-DUB	Bushes - Steel - DUB - Split - Flanged
8.000 -0.000/-0.028	10.000 +0.015/-0.000	5.500 +0.25/-0.25	15.00	1.00	BF00800-01000-00550-SS6	Bushes - Stainless Steel and PTFE - Flanged
8.000 -0.000/-0.028	10.000 +0.015/-0.000	5.500 +0.25/-0.25	15.00	1.00	BF00800-01000-00550-DP4	Bushes - Steel - DP4 - Split - Flanged
8.000 -0.000/-0.028	10.000 +0.015/-0.000	5.500 +0.25/-0.25	15.00	1.00	BF00800-01000-00550-DU	Bushes - Steel - DU - Split - Flanged
8.000 -0.000/-0.028	10.000 +0.055/-0.000	6.000 +0.00/-0.30			BP00800-01000-00600-SS6	Bushes - Stainless Steel and PTFE - Unflanged
8.000 -0.000/-0.015	10.000 +0.015/-0.000	6.000 +0.25/-0.25			BP00800-01000-00600-DP4	Bushes - Steel - DP4 - Split - Unflanged
8.000 -0.000/-0.015	10.000 +0.055/-0.000	6.000 +0.25/-0.25			BP00800-01000-00600-DU	Bushes - Steel - DU - Split - Unflanged
8.000 -0.000/-0.028	10.000 +0.015/-0.000	7.500 +0.25/-0.25	15.00	1.00	BF00800-01000-00750-DU	Bushes - Steel - DU - Split - Flanged
8.000 -0.000/-0.015	10.000 +0.015/-0.000	7.500 +0.25/-0.25	15.00	1.00	BF00800-01000-00750-DP4	Bushes - Steel - DP4 - Split - Flanged
8.000 -0.000/-0.028	10.000 +0.015/-0.000	7.500 +0.25/-0.25	15.00	1.00	BF00800-01000-00750-SS6	Bushes - Stainless Steel and PTFE - Flanged
8.000 -0.000/-0.015	10.000 +0.055/-0.000	8.000 +0.25/-0.25			BP00800-01000-00800-DX	Bushes - Steel - DX - Split - Unflanged
8.000 -0.000/-0.028	10.000 +0.055/-0.000	8.000 +0.00/-0.30			BP00800-01000-00800-SS6	Bushes - Stainless Steel and PTFE - Unflanged
8.000 -0.000/-0.015	10.000 +0.055/-0.000	8.000 +0.25/-0.25			BP00800-01000-00800-DUB	Bushes - Steel - DUB - Split - Unflanged
8.000 -0.000/-0.015	10.000 +0.055/-0.000	8.000 +0.25/-0.25			BP00800-01000-00800-DU	Bushes - Steel - DU - Split - Unflanged
8.000 -0.000/-0.015	10.000 +0.015/-0.000	8.000 +0.25/-0.25			BP00800-01000-00800-DP4	Bushes - Steel - DP4 - Split - Unflanged
8.000 -0.000/-0.028	10.000 +0.015/-0.000	9.500 +0.25/-0.25	15.00	0.95	BF00800-01000-00950-DUB	Bushes - Steel - DUB - Split - Flanged
8.000 -0.000/-0.015	10.000 +0.015/-0.000	9.500 +0.25/-0.25	15.00	1.00	BF00800-01000-00950-DP4	Bushes - Steel - DP4 - Split - Flanged
8.000 -0.000/-0.028	10.000 +0.015/-0.000	9.500 +0.25/-0.25	15.00	1.00	BF00800-01000-00950-DU	Bushes - Steel - DU - Split - Flanged
8.000 -0.000/-0.015	10.000 +0.015/-0.000	10.000 +0.25/-0.25			BP00800-01000-01000-DP4	Bushes - Steel - DP4 - Split - Unflanged
8.000 -0.000/-0.015	10.000 +0.055/-0.000	10.000 +0.25/-0.25			BP00800-01000-01000-DU	Bushes - Steel - DU - Split - Unflanged
8.000 -0.000/-0.015	10.000 +0.055/-0.000	10.000 +0.25/-0.25			BP00800-01000-01000-DUB	Bushes - Steel - DUB - Split - Unflanged
8.000 -0.000/-0.015	10.000 +0.055/-0.000	10.000 +0.25/-0.25			BP00800-01000-01000-DX	Bushes - Steel - DX - Split - Unflanged
8.000 -0.000/-0.028	10.000 +0.055/-0.000	10.000 +0.00/-0.30			BP00800-01000-01000-SS6	Bushes - Stainless Steel and PTFE - Unflanged
8.000 +/-0.0254	10.000 +0.0508/+0.0762	10.000 +/-0.127			BP00800-01000-01000-BLG	Bushes - Bronze - Solid - Leaded Gunmetal
8.000 -0.000/-0.015	10.000 +0.055/-0.000	12.000 +0.25/-0.25			BP00800-01000-01200-DX	Bushes - Steel - DX - Split - Unflanged
8.000 -0.000/-0.015	10.000 +0.015/-0.000	12.000 +0.25/-0.25			BP00800-01000-01200-DP4	Bushes - Steel - DP4 - Split - Unflanged
8.000 -0.000/-0.015	10.000 +0.055/-0.000	12.000 +0.25/-0.25			BP00800-01000-01200-DU	Bushes - Steel - DU - Split - Unflanged
8.000 -0.000/-0.028	10.000 +0.055/-0.000	12.000 +0.00/-0.30			BP00800-01000-01200-SS6	Bushes - Stainless Steel and PTFE - Unflanged
8.000 -0.000/-0.015	10.000 +0.055/-0.000	12.000 +0.25/-0.25			BP00800-01000-01200-DUB	Bushes - Steel - DUB - Split - Unflanged
8.000 -0.000/-0.015	10.000 +0.055/-0.000	15.000 +0.25/-0.25			BP00800-01000-01500-DU	Bushes - Steel - DU - Split - Unflanged
8.000 -0.000/-0.028	10.000 +0.055/-0.000	15.000 +0.00/-0.30			BP00800-01000-01500-SS6	Bushes - Stainless Steel and PTFE - Unflanged
8.000 -0.000/-0.015	10.000 +0.055/-0.000	15.000 +0.25/-0.25			BP00800-01000-01500-DP4	Bushes - Steel - DP4 - Split - Unflanged
8.000 +/-0.0254	10.000 +0.0508/+0.0762	20.000 +/-0.127			BP00800-01000-02000-BLG	Bushes - Bronze - Solid - Leaded Gunmetal

Stocked or Short Delivery

Usually Available

Long delivery or not in current production

ID	OD	B	DF	bf	Part Number	Type
8.000 x 10.000 mm (0.315 x 0.394 in.)						
8.000 +/-0.0254	10.000 +0.0508/+0.0762	30.000 +/-0.127			BP00800-01000-03000-BLG	Bushes - Bronze - Solid - Leaded Gunmetal
8.000 +/-0.0254	10.000 +0.0508/+0.0762	40.000 +/-0.127			BP00800-01000-04000-BLG	Bushes - Bronze - Solid - Leaded Gunmetal
8.000 x 11.000 mm (0.315 x 0.433 in.)						
8.000 +0.005/+0.020	11.000 +0.028/+0.046	6.000 +/-0.090			BP00800-01100-00600-BSO	Bushes - Bronze - Sintered - Unflanged - Oilite
8.000 +0.005/+0.020	11.000 +0.028/+0.046	8.000 +/-0.110			BP00800-01100-00800-BSO	Bushes - Bronze - Sintered - Unflanged - Oilite
8.000 +0.005/+0.020	11.000 +0.028/+0.046	12.000 +/-0.130			BP00800-01100-01200-BSO	Bushes - Bronze - Sintered - Unflanged - Oilite
8.000 x 12.000 mm (0.315 x 0.472 in.)						
8.000 +0.025/+0.040	12.000 +0.023/+0.041	6.000 +0/-0.200			BP00800-01200-00600-BS	Bushes - Bronze - Sintered - Unflanged
8.000 +0.005/+0.020	12.000 +0.028/+0.046	6.000 +/-0.090			BP00800-01200-00600-BSO	Bushes - Bronze - Sintered - Unflanged - Oilite
8.000 +0.005/+0.020	12.000 +0.028/+0.046	6.000 +/-0.090	16.00	2.00	BF00800-01200-00600-BSO	Bushes - Bronze - Sintered - Flanged - Oilite
8.000 +0.025/+0.040	12.000 +0.023/+0.041	8.000 +0/-0.200			BP00800-01200-00800-BS	Bushes - Bronze - Sintered - Unflanged
8.000 +0.005/+0.020	12.000 +0.028/+0.046	8.000 +/-0.110			BP00800-01200-00800-BSO	Bushes - Bronze - Sintered - Unflanged - Oilite
8.000 +0.005/+0.020	12.000 +0.028/+0.046	8.000 +/-0.110	16.00	2.00	BF00800-01200-00800-BSO	Bushes - Bronze - Sintered - Flanged - Oilite
8.000 +0.025/+0.040	12.000 +0.023/+0.041	8.000 +0/-0.200	16.00	3.00	BF00800-01200-00800-BS	Bushes - Bronze - Sintered - Flanged
8.000 +/-0.0254	12.000 +0.0508/+0.0762	10.000 +/-0.127			BP00800-01200-01000-BLG	Bushes - Bronze - Solid - Leaded Gunmetal
8.000 +0.025/+0.040	12.000 +0.023/+0.041	12.000 +0/-0.200			BP00800-01200-01200-BS	Bushes - Bronze - Sintered - Unflanged
8.000 +0.005/+0.020	12.000 +0.028/+0.046	12.000 +/-0.130			BP00800-01200-01200-BSO	Bushes - Bronze - Sintered - Unflanged - Oilite
8.000 +0.005/+0.020	12.000 +0.028/+0.046	12.000 +/-0.130	16.00	2.00	BF00800-01200-01200-BSO	Bushes - Bronze - Sintered - Flanged - Oilite
8.000 +0.005/+0.020	12.000 +0.028/+0.046	16.000 +/-0.130			BP00800-01200-01600-BSO	Bushes - Bronze - Sintered - Unflanged - Oilite
8.000 +0.005/+0.020	12.000 +0.028/+0.046	16.000 +/-0.130	16.00	2.00	BF00800-01200-01600-BSO	Bushes - Bronze - Sintered - Flanged - Oilite
8.000 +0.005/+0.020	12.000 +0.028/+0.046	20.000 +/-0.160			BP00800-01200-02000-BSO	Bushes - Bronze - Sintered - Unflanged - Oilite
8.000 +/-0.0254	12.000 +0.0508/+0.0762	20.000 +/-0.127			BP00800-01200-02000-BLG	Bushes - Bronze - Solid - Leaded Gunmetal
8.000 +/-0.0254	12.000 +0.0508/+0.0762	30.000 +/-0.127			BP00800-01200-03000-BLG	Bushes - Bronze - Solid - Leaded Gunmetal
8.000 +/-0.0254	12.000 +0.0508/+0.0762	40.000 +/-0.127			BP00800-01200-04000-BLG	Bushes - Bronze - Solid - Leaded Gunmetal
8.000 x 14.000 mm (0.315 x 0.551 in.)						
8.000 +0.025/+0.040	14.000 +0.023/+0.041	8.000 +0/-0.200			BP00800-01400-00800-BS	Bushes - Bronze - Sintered - Unflanged
8.000 +0.025/+0.040	14.000 +0.023/+0.041	12.000 +0/-0.200			BP00800-01400-01200-BS	Bushes - Bronze - Sintered - Unflanged
8.000 +0.025/+0.040	14.000 +0.023/+0.041	16.000 +0/-0.200			BP00800-01400-01600-BS	Bushes - Bronze - Sintered - Unflanged
8.000 x 16.000 mm (0.315 x 0.630 in.)						
8.000 +0.015/-0	16.000 +0/-0.011	6.000 +0/-0.170			BP00800-01600-00600-BS	Bushes - Bronze - Sintered - Unflanged
8.000 +0.015/-0	16.000 +0/-0.011	6.000 +0/-0.178	18.00	1.00	BF00800-01600-00600-BS	Bushes - Bronze - Sintered - Flanged
8.334 x 11.906 mm (0.328 x 0.469 in.)						
8.334 +0.025/-0	11.906 +0.058/+0.083	12.700 +/-0.127			BP00833-01191-01270-BS	Bushes - Bronze - Sintered - Unflanged
8.334 +0.025/-0	11.906 +0.058/+0.083	19.050 +/-0.127			BP00833-01191-01905-BS	Bushes - Bronze - Sintered - Unflanged
8.334 x 12.700 mm (0.328 x 0.500 in.)						
8.334 +0.025/-0	12.700 +0.051/+0.076	11.100 +/-0.127			BP00833-01270-01110-BS	Bushes - Bronze - Sintered - Unflanged
9.000 x 12.000 mm (0.354 x 0.472 in.)						
9.000 +/-0.0254	12.000 -0.020/-0.100	4.000 +/-0.127			BP00900-01200-00400-BLG	Bushes - Bronze - Solid - Leaded Gunmetal
9.000 +0.005/+0.020	12.000 +0.028/+0.046	10.000 +/-0.110			BP00900-01200-01000-BSO	Bushes - Bronze - Sintered - Unflanged - Oilite

 Stocked or Short Delivery

 Usually Available

 Long delivery or not in current production

ID	OD	B	DF	bf	Part Number	Type
9.000 x 12.000 mm (0.354 x 0.472 in.)						
9.000 +0.005/+0.020	12.000 +0.028/+0.046	14.000 +/-0.130			BP00900-01200-01400-BSO	Bushes - Bronze - Sintered - Unflanged - Oilite
9.000 x 14.000 mm (0.354 x 0.551 in.)						
9.000 +0.005/+0.020	14.000 +0.028/+0.046	6.000 +/-0.090			BP00900-01400-00600-BSO	Bushes - Bronze - Sintered - Unflanged - Oilite
9.000 +0.005/+0.020	14.000 +0.028/+0.046	10.000 +/-0.110			BP00900-01400-01000-BSO	Bushes - Bronze - Sintered - Unflanged - Oilite
9.000 +0.005/+0.020	14.000 +0.028/+0.046	14.000 +/-0.130			BP00900-01400-01400-BSO	Bushes - Bronze - Sintered - Unflanged - Oilite
9.525 x 11.906 mm (0.375 x 0.469 in.)						
9.525 -0.025/-0.048	11.906 +0.009/-0.009	4.763 +0.25/-0.25			BP00953-01191-00476-DP4	Bushes - Steel - DP4 - Split - Unflanged
9.525 -0.025/-0.048	11.906 +0.009/-0.009	4.763 +0.00/-0.30			BP00953-01191-00476-DU	Bushes - Steel - DU - Split - Unflanged
9.525 -0.025/-0.048	11.906 +0.009/-0.009	4.763 +0.25/-0.25			BP00953-01191-00476-SS6	Bushes - Stainless Steel and PTFE - Unflanged
9.525 -0.025/-0.048	11.906 +0.009/-0.009	6.350 +0.25/-0.25			BP00953-01191-00635-DP4	Bushes - Steel - DP4 - Split - Unflanged
9.525 -0.025/-0.048	11.906 +0.009/-0.009	6.350 +0.25/-0.25			BP00953-01191-00635-DU	Bushes - Steel - DU - Split - Unflanged
9.525 -0.025/-0.048	11.906 +0.009/-0.009	6.350 +0.25/-0.25			BP00953-01191-00635-SS6	Bushes - Stainless Steel and PTFE - Unflanged
9.525 -0.025/-0.048	11.906 +0.009/-0.009	6.350 +0.25/-0.25	17.97	1.32	BF00953-01191-00635-DP4	Bushes - Steel - DP4 - Split - Flanged
9.525 -0.025/-0.048	11.906 +0.009/-0.009	6.350 +0.25/-0.25	17.97	1.32	BF00953-01191-00635-SS6	Bushes - Stainless Steel and PTFE - Flanged
9.525 -0.025/-0.048	11.906 +0.009/-0.009	6.350 +0.25/-0.25	17.97	1.32	BF00953-01191-00635-DU	Bushes - Steel - DU - Split - Flanged
9.525 -0.025/-0.048	11.906 +0.009/-0.009	9.525 +0.00/-0.30			BP00953-01191-00953-DU	Bushes - Steel - DU - Split - Unflanged
9.525 -0.025/-0.048	11.906 +0.009/-0.009	9.525 +0.00/-0.30			BP00953-01191-00953-DP4	Bushes - Steel - DP4 - Split - Unflanged
9.525 -0.025/-0.048	11.906 +0.009/-0.009	9.525 +0.25/-0.25			BP00953-01191-00953-SS6	Bushes - Stainless Steel and PTFE - Unflanged
9.525 -0.025/-0.048	11.906 +0.009/-0.009	9.525 +0.25/-0.25	17.97	1.32	BF00953-01191-00953-DU	Bushes - Steel - DU - Split - Flanged
9.525 -0.025/-0.048	11.906 +0.009/-0.009	9.525 +0.25/-0.25	17.97	1.32	BF00953-01191-00953-DP4	Bushes - Steel - DP4 - Split - Flanged
9.525 -0.025/-0.048	11.906 +0.009/-0.009	9.525 +0.25/-0.25	17.97	1.32	BF00953-01191-00953-SS6	Bushes - Stainless Steel and PTFE - Flanged
9.525 -0.025/-0.048	11.906 +0.009/-0.009	12.700 +0.25/-0.25			BP00953-01191-01270-DU	Bushes - Steel - DU - Split - Unflanged
9.525 -0.025/-0.048	11.906 +0.009/-0.009	12.700 +0.00/-0.30			BP00953-01191-01270-DP4	Bushes - Steel - DP4 - Split - Unflanged
9.525 -0.025/-0.048	11.906 +0.009/-0.009	12.700 +0.25/-0.25			BP00953-01191-01270-SS6	Bushes - Stainless Steel and PTFE - Unflanged
9.525 -0.025/-0.048	11.906 +0.009/-0.009	12.700 +0.25/-0.25	17.97	1.32	BF00953-01191-01270-DP4	Bushes - Steel - DP4 - Split - Flanged
9.525 -0.025/-0.048	11.906 +0.009/-0.009	12.700 +0.25/-0.25	17.97	1.32	BF00953-01191-01270-DU	Bushes - Steel - DU - Split - Flanged
9.525 -0.025/-0.048	11.906 +0.009/-0.009	12.700 +0.25/-0.25	17.97	1.32	BF00953-01191-01270-SS6	Bushes - Stainless Steel and PTFE - Flanged
9.525 -0.025/-0.048	11.906 +0.009/-0.009	15.875 +0.25/-0.25			BP00953-01191-01588-SS6	Bushes - Stainless Steel and PTFE - Unflanged
9.525 -0.025/-0.048	11.906 +0.009/-0.009	15.875 +0.25/-0.25			BP00953-01191-01588-DU	Bushes - Steel - DU - Split - Unflanged
9.525 -0.025/-0.048	11.906 +0.009/-0.009	15.875 +0.00/-0.30			BP00953-01191-01588-DP4	Bushes - Steel - DP4 - Split - Unflanged
9.525 -0.025/-0.048	11.906 +0.009/-0.009	19.050 +0.00/-0.30			BP00953-01191-01905-DP4	Bushes - Steel - DP4 - Split - Unflanged
9.525 -0.025/-0.048	11.906 +0.009/-0.009	19.050 +0.25/-0.25			BP00953-01191-01905-DU	Bushes - Steel - DU - Split - Unflanged
9.525 -0.025/-0.048	11.906 +0.009/-0.009	19.050 +0.25/-0.25			BP00953-01191-01905-SS6	Bushes - Stainless Steel and PTFE - Unflanged
9.525 -0.025/-0.048	11.906 +0.009/-0.009	19.050 +0.25/-0.25	17.97	1.32	BF00953-01191-01905-SS6	Bushes - Stainless Steel and PTFE - Flanged
9.525 -0.025/-0.048	11.906 +0.009/-0.009	19.050 +0.25/-0.25	17.97	1.32	BF00953-01191-01905-DU	Bushes - Steel - DU - Split - Flanged
9.525 -0.025/-0.048	11.906 +0.009/-0.009	19.050 +0.25/-0.25	17.97	1.32	BF00953-01191-01905-DP4	Bushes - Steel - DP4 - Split - Flanged
9.525 x 12.700 mm (0.375 x 0.500 in.)						
9.525 +0.025/+0.050	12.700 +0.051/+0.076	4.750 +0/-0.102			BP00953-01270-00475-BS	Bushes - Bronze - Sintered - Unflanged
9.525 +0.0254/+0.0508	12.700 +0.0508/+0.0762	6.350 +0.127/-0.127			BP00953-01270-00635-BS	Bushes - Bronze - Sintered - Unflanged
9.525 +0.0254/+0.0508	12.700 +0.0508/+0.0762	6.350 +0.127/-0.127			BP00953-01270-00635-BFG	Bushes - Bronze - Sintered - ECO841 Food Grade - Unflanged

 Stocked or Short Delivery

 Usually Available

 Long delivery or not in current production

ID	OD	B	DF	bf	Part Number	Type
9.525 x 12.700 mm (0.375 x 0.500 in.)						
9.525 +0.0254/+0.0508	12.700 +0.0508/+0.0762	9.525 +0.127/-0.127			BP00953-01270-00953-BS	Bushes - Bronze - Sintered - Unflanged
9.525 +0.0254/+0.0508	12.700 +0.0508/+0.0762	9.525 +0.127/-0.127			BP00953-01270-00953-BFG	Bushes - Bronze - Sintered - ECO841 Food Grade - Unflanged
9.525 +0.005/+0.020	12.700 +0.028/+0.046	9.525 +/-0.110			BP00953-01270-00953-BSO	Bushes - Bronze - Sintered - Unflanged - Oilite
9.525 +0.051/+0.076	12.700 +0.025/-0.051	9.525 +/-0.127	15.88	1.59	BF00953-01270-00953-BS08	Bushes - Bronze - Sintered - Flanged
9.525 +0.025/+0.050	12.700 +0.026/+0.051	9.525 +/-0.127	17.46	2.38	BF00953-01270-00953-BS05	Bushes - Bronze - Sintered - Flanged
9.525 +0.025/+0.050	12.700 +0.077/+0.102	10.262 +/-0.127	14.27	1.65	BF00953-01270-01026-BS	Bushes - Bronze - Sintered - Flanged
9.525 +0.025/+0.050	12.700 +0.026/+0.051	10.319 +/-0.127	17.46	2.38	BF00953-01270-01032-BS	Bushes - Bronze - Sintered - Flanged
9.525 +0.025/+0.050	12.700 +0.051/+0.076	12.700 +/-0.127			BP00953-01270-01270-BS	Bushes - Bronze - Sintered - Unflanged
9.525 +0.005/+0.020	12.700 +0.028/+0.046	12.700 +/-0.130			BP00953-01270-01270-BSO	Bushes - Bronze - Sintered - Unflanged - Oilite
9.525 +0.0254/+0.0508	12.700 +0.0508/+0.0762	12.700 +0.127/-0.127			BP00953-01270-01270-BFG	Bushes - Bronze - Sintered - ECO841 Food Grade - Unflanged
9.525 +/-0.0254	12.700 +0.0508/+0.0762	12.700 +/-0.127			BP00953-01270-01270-BC9	Bushes - Bronze - Solid - Leaded Gunmetal
9.525 +0.005/+0.020	12.700 +0.028/+0.046	12.700 +/-0.130	15.88	3.56	BF00953-01270-01270-BSO	Bushes - Bronze - Sintered - Flanged - Oilite
9.525 +0.025/+0.050	12.700 +0.026/+0.051	12.700 +/-0.127	17.46	2.38	BF00953-01270-01270-BS05	Bushes - Bronze - Sintered - Flanged
9.525 +0.025/+0.050	12.700 +0.051/+0.076	15.875 +/-0.127			BP00953-01270-01588-BS05	Bushes - Bronze - Sintered - Unflanged
9.525 +0.005/+0.020	12.700 +0.028/+0.046	15.875 +/-0.130			BP00953-01270-01588-BSO	Bushes - Bronze - Sintered - Unflanged - Oilite
9.525 +0.0254/+0.0508	12.700 +0.0508/+0.0762	15.875 +0.127/-0.127			BP00953-01270-01588-BFG	Bushes - Bronze - Sintered - ECO841 Food Grade - Unflanged
9.525 +0.025/+0.050	12.700 +0.026/+0.051	15.875 +/-0.127	17.46	2.38	BF00953-01270-01588-BS	Bushes - Bronze - Sintered - Flanged
9.525 +/-0.0254	12.700 +0.0508/+0.0762	15.880 +/-0.127			BP00953-01270-01588-BLG	Bushes - Bronze - Solid - Leaded Gunmetal
9.525 +0.025/+0.051	12.700 +0.077/+0.102	17.678 +0/-0.152	14.27	1.65	BF00953-01270-01768-BS	Bushes - Bronze - Sintered - Flanged
9.525 +0.038/-0.013	12.700 +0.025/-0.051	19.050 +/-0.127			BP00953-01270-01905-BS	Bushes - Bronze - Sintered - Unflanged
9.525 +0.005/+0.020	12.700 +0.028/+0.046	19.050 +/-0.160			BP00953-01270-01905-BSO	Bushes - Bronze - Sintered - Unflanged - Oilite
9.525 +0.0254/+0.0508	12.700 +0.0508/+0.0762	19.050 +0.127/-0.127			BP00953-01270-01905-BFG	Bushes - Bronze - Sintered - ECO841 Food Grade - Unflanged
9.525 +/-0.0254	12.700 +0.0508/+0.0762	19.050 +/-0.127			BP00953-01270-01905-BC9	Bushes - Bronze - Solid - Leaded Gunmetal
9.525 +/-0.0254	12.700 +0.0508/+0.0762	19.050 +/-0.127			BP00953-01270-01905-BLG	Bushes - Bronze - Solid - Leaded Gunmetal
9.525 +0.025/+0.050	12.700 +0.026/+0.051	19.050 +/-0.127	17.46	2.38	BF00953-01270-01905-BS	Bushes - Bronze - Sintered - Flanged
9.525 +0.025/+0.050	12.700 +0.051/+0.076	20.650 +/-0.127			BP00953-01270-02065-BS	Bushes - Bronze - Sintered - Unflanged
9.525 +0.0254/+0.0508	12.700 +0.0508/+0.0762	22.225 +0.127/-0.127			BP00953-01270-02223-BS	Bushes - Bronze - Sintered - Unflanged
9.525 +0.0254/+0.0508	12.700 +0.0508/+0.0762	22.225 +0.127/-0.127			BP00953-01270-02223-BFG	Bushes - Bronze - Sintered - ECO841 Food Grade - Unflanged
9.525 +0.005/+0.020	12.700 +0.028/+0.046	22.225 +/-0.160			BP00953-01270-02223-BSO	Bushes - Bronze - Sintered - Unflanged - Oilite
9.525 +0.005/+0.020	12.700 +0.028/+0.046	22.225 +/-0.160	15.88	3.56	BF00953-01270-02223-BSO	Bushes - Bronze - Sintered - Flanged - Oilite
9.525 +0.025/-0.025	12.700 +0.025/+0.076	25.400 +/-0.397			BP00953-01270-02540-BS	Bushes - Bronze - Sintered - Unflanged
9.525 +0.0254/+0.0508	12.700 +0.0508/+0.0762	25.400 +0.127/-0.127			BP00953-01278-02540-BS	Bushes - Bronze - Sintered - Unflanged
9.525 +0.005/+0.020	12.700 +0.028/+0.046	25.400 +/-0.160			BP00953-01270-02540-BSO	Bushes - Bronze - Sintered - Unflanged - Oilite
9.525 +0.0254/+0.0508	12.700 +0.0508/+0.0762	25.400 +0.127/-0.127			BP00953-01270-02540-BFG	Bushes - Bronze - Sintered - ECO841 Food Grade - Unflanged
9.525 +/-0.0254	12.700 +0.0508/+0.0762	25.400 +/-0.127			BP00953-01270-02540-BC9	Bushes - Bronze - Solid - Leaded Gunmetal
9.525 +/-0.0254	12.700 +0.0508/+0.0762	25.400 +/-0.127			BP00953-01270-02540-BLG	Bushes - Bronze - Solid - Leaded Gunmetal
9.525 +0.025/+0.050	12.700 +0.026/+0.051	25.400 +/-0.127	17.46	2.38	BF00953-01270-02540-BS	Bushes - Bronze - Sintered - Flanged
9.525 +0.0254/+0.0508	12.700 +0.0508/+0.0762	31.750 +0.127/-0.127			BP00953-01270-03175-BS	Bushes - Bronze - Sintered - Unflanged

Stocked or Short Delivery

Usually Available

Long delivery or not in current production

ID	OD	B	DF	bf	Part Number	Type
9.525 x 12.700 mm (0.375 x 0.500 in.)						
9.525 +0.0254/+0.0508	12.700 +0.0508/+0.0762	31.750 +0.127/-0.127			BP00953-01270-03175-BFG	Bushes - Bronze - Sintered - ECO841 Food Grade - Unflanged
9.525 +/-0.0254	12.700 +0.0508/+0.0762	31.750 +/-0.127			BP00953-01270-03175-BC9	Bushes - Bronze - Solid - Leaded Gunmetal
9.525 +0.025/+0.050	12.700 +0.026/+0.051	31.750 +/-0.127	17.46	2.38	BF00953-01270-03175-BS	Bushes - Bronze - Sintered - Flanged
9.525 +/-0.0254	12.700 +0.0508/+0.0762	38.100 +/-0.127			BP00953-01270-03810-BC9	Bushes - Bronze - Solid - Leaded Gunmetal
9.525 +/-0.0254	12.700 +0.0508/+0.0762	38.100 +/-0.127			BP00953-01270-03810-BLG	Bushes - Bronze - Solid - Leaded Gunmetal
9.525 +/-0.0254	12.700 +0.0508/+0.0762	50.800 +/-0.127			BP00953-01270-05080-BLG	Bushes - Bronze - Solid - Leaded Gunmetal

9.525 x 14.288 mm (0.375 x 0.563 in.)						
9.525 +0.025/+0.050	14.288 +0.052/+0.077	8.331 +/-0.127			BP00953-01429-00833-BS	Bushes - Bronze - Sintered - Unflanged
9.525 +0.050/+0.076	14.288 +0.039/+0.064	9.525 +/-0.127			BP00953-01429-00953-BS	Bushes - Bronze - Sintered - Unflanged
9.525 +0.025/+0.050	14.288 +0.052/+0.077	12.700 +/-0.127			BP00953-01429-01270-BS05	Bushes - Bronze - Sintered - Unflanged
9.525 +0.050/+0.076	14.288 +0.039/+0.064	12.700 +/-0.127			BP00953-01429-01270-BS08	Bushes - Bronze - Sintered - Unflanged
9.525 +0.0254/+0.0508	14.288 +0.0508/+0.0762	12.700 +0.127/-0.127			BP00953-01429-01270-BFG	Bushes - Bronze - Sintered - ECO841 Food Grade - Unflanged
9.525 +0.050/+0.076	14.288 +0.039/+0.064	15.875 +/-0.127			BP00953-01429-01588-BS	Bushes - Bronze - Sintered - Unflanged
9.525 +0.025/+0.051	14.288 +0.063/+0.088	16.764 +/-0.127	19.05	2.36	BF00953-01429-01676-BS	Bushes - Bronze - Sintered - Flanged
9.525 +0.0254/+0.0508	14.288 +0.0508/+0.0762	19.050 +0.127/-0.127			BP00953-01429-01905-BS	Bushes - Bronze - Sintered - Unflanged
9.525 +0.0254/+0.0508	14.288 +0.0508/+0.0762	19.050 +0.127/-0.127			BP00953-01429-01905-BFG	Bushes - Bronze - Sintered - ECO841 Food Grade - Unflanged
9.525 +0.025/+0.050	14.288 +0.025/+0.050	19.050 +/-0.127	19.05	3.18	BF00953-01429-01905-BS	Bushes - Bronze - Sintered - Flanged
9.525 +0.025/+0.050	14.288 +0.052/+0.077	19.177 +/-0.127			BP00953-01429-01918-BS	Bushes - Bronze - Sintered - Unflanged
9.525 +0.050/+0.076	14.288 +0.039/+0.064	22.225 +/-0.127			BP00953-01429-02223-BS	Bushes - Bronze - Sintered - Unflanged
9.525 +0.025/+0.050	14.288 +0.052/+0.077	25.273 +/-0.127			BP00953-01429-02527-BS	Bushes - Bronze - Sintered - Unflanged
9.525 +0.0254/+0.0508	14.288 +0.0508/+0.0762	25.400 +0.127/-0.127			BP00953-01429-02540-BS	Bushes - Bronze - Sintered - Unflanged
9.525 +0.0254/+0.0508	14.288 +0.0508/+0.0762	25.400 +0.127/-0.127			BP00953-01429-02540-BFG	Bushes - Bronze - Sintered - ECO841 Food Grade - Unflanged
9.525 +/-0.0254	14.288 +0.0508/+0.0762	25.400 +/-0.127			BP00953-01429-02540-BC9	Bushes - Bronze - Solid - Leaded Gunmetal
9.525 +0.0254/+0.0508	14.288 +0.0508/+0.0762	31.750 +0.127/-0.127			BP00953-01429-03175-BS	Bushes - Bronze - Sintered - Unflanged
9.525 +0.0254/+0.0508	14.288 +0.0508/+0.0762	31.750 +0.127/-0.127			BP00953-01429-03175-BFG	Bushes - Bronze - Sintered - ECO841 Food Grade - Unflanged
9.525 +0.025/+0.050	14.288 +0.025/+0.050	31.750 +/-0.127	19.05	3.18	BF00953-01429-03175-BS	Bushes - Bronze - Sintered - Flanged

9.525 x 15.875 mm (0.375 x 0.625 in.)						
9.525 +0.025/+0.050	15.875 +0.051/+0.076	7.925 +/-0.127			BP00953-01588-00793-BS	Bushes - Bronze - Sintered - Unflanged
9.525 +0.050/+0.076	15.875 +0.051/+0.076	9.525 +/-0.127			BP00953-01588-00953-BS	Bushes - Bronze - Sintered - Unflanged
9.525 +0.0254/+0.0508	15.875 +0.0508/+0.0762	9.525 +0.127/-0.127			BP00953-01588-00953-BFG	Bushes - Bronze - Sintered - ECO841 Food Grade - Unflanged
9.525 +0.005/+0.020	15.875 +0.028/+0.046	9.525 +/-0.110	19.05	3.18	BF00953-01588-00953-BSO	Bushes - Bronze - Sintered - Flanged - Oilite
9.525 +0.025/+0.050	15.875 +0.051/+0.076	10.973 +/-0.127			BP00953-01588-01097-BS	Bushes - Bronze - Sintered - Unflanged
9.525 +0.050/+0.076	15.875 +0.051/+0.076	12.700 +/-0.127			BP00953-01588-01270-BS	Bushes - Bronze - Sintered - Unflanged
9.525 +0.038/+0.063	15.875 +0.025/+0.050	12.700 +0.00/-0.51			BP00953-01588-01270-AF	Bushes - Aluminium - Frelon Lined - Unflanged
9.525 +0.0254/+0.0508	15.875 +0.0508/+0.0762	12.700 +0.127/-0.127			BP00953-01588-01270-BFG	Bushes - Bronze - Sintered - ECO841 Food Grade - Unflanged
9.525 +0.005/+0.020	15.875 +0.028/+0.046	12.700 +/-0.130	19.05	3.18	BF00953-01588-01270-BSO	Bushes - Bronze - Sintered - Flanged - Oilite
9.525 +0.025/+0.050	15.875 +0.026/+0.051	12.700 +/-0.127	22.23	3.18	BF00953-01588-01270-BS	Bushes - Bronze - Sintered - Flanged

Stocked or Short Delivery

Usually Available

Long delivery or not in current production

ID	OD	B	DF	bf	Part Number	Type
9.525 x 15.875 mm (0.375 x 0.625 in.)						
9.525 +0.038/+0.063	15.875 +0.025/+0.050	12.700 +0.00/-0.51	22.23	3.18	BF00953-01588-01270-AF	Bushes - Aluminium - Frelon Lined - Flanged
9.525 +0.051/-0.076	15.875 +0.077/+0.102	15.494 +/-0.127	22.23	1.60	BF00953-01588-01549-BS	Bushes - Bronze - Sintered - Flanged
9.525 +0.050/+0.076	15.875 +0.051/+0.076	15.875 +/-0.127			BP00953-01588-01588-BS	Bushes - Bronze - Sintered - Unflanged
9.525 +0.005/+0.020	15.875 +0.028/+0.046	15.875 +/-0.130	19.05	3.18	BF00953-01588-01588-BSO	Bushes - Bronze - Sintered - Flanged - Oilite
9.525 +0.025/+0.050	15.875 +0.051/+0.076	15.926 +0/-0.102			BP00953-01588-01593-BS	Bushes - Bronze - Sintered - Unflanged
9.525 +0.038/+0.063	15.875 +0.025/+0.050	19.050 +0.00/-0.51			BP00953-01588-01905-AF	Bushes - Aluminium - Frelon Lined - Unflanged
9.525 +0.050/+0.076	15.875 +0.051/+0.076	19.050 +/-0.127			BP00953-01588-01905-BS	Bushes - Bronze - Sintered - Unflanged
9.525 +0.0254/+0.0508	15.875 +0.0508/+0.0762	19.050 +0.127/-0.127			BP00953-01588-01905-BFG	Bushes - Bronze - Sintered - ECO841 Food Grade - Unflanged
9.525 +/-0.0254	15.875 +0.0508/+0.0762	19.050 +/-0.127			BP00953-01588-01905-BC9	Bushes - Bronze - Solid - Lead Gunmetal
9.525 +0.005/+0.020	15.875 +0.028/+0.046	19.050 +/-0.160	19.05	3.18	BF00953-01588-01905-BSO	Bushes - Bronze - Sintered - Flanged - Oilite
9.525 +0.025/+0.050	15.875 +0.026/+0.051	19.050 +/-0.127	22.23	3.18	BF00953-01588-01905-BS	Bushes - Bronze - Sintered - Flanged
9.525 +0.038/+0.063	15.875 +0.025/+0.050	19.050 +0.00/-0.51	22.23	3.18	BF00953-01588-01905-AF	Bushes - Aluminium - Frelon Lined - Flanged
9.525 +0.050/+0.076	15.875 +0.051/+0.076	22.225 +/-0.127			BP00953-01588-02223-BS	Bushes - Bronze - Sintered - Unflanged
9.525 +0.050/+0.076	15.875 +0.051/+0.076	25.400 +/-0.127			BP00953-01588-02540-BS	Bushes - Bronze - Sintered - Unflanged
9.525 +/-0.0254	15.875 +0.0508/+0.0762	25.400 +/-0.127			BP00953-01588-02540-BC9	Bushes - Bronze - Solid - Lead Gunmetal
9.525 +0.025/+0.050	15.875 +0.026/+0.051	25.400 +/-0.127	22.23	3.18	BF00953-01588-02540-BS	Bushes - Bronze - Sintered - Flanged
9.525 +0.050/+0.076	15.875 +0.051/+0.076	31.750 +/-0.127			BP00953-01588-03175-BS	Bushes - Bronze - Sintered - Unflanged
9.525 +0.025/+0.050	15.875 +0.026/+0.051	31.750 +/-0.127	22.23	3.18	BF00953-01588-03175-BS	Bushes - Bronze - Sintered - Flanged
9.525 +0.050/+0.076	15.875 +0.051/+0.076	38.100 +/-0.127			BP00953-01588-03810-BS	Bushes - Bronze - Sintered - Unflanged
9.525 x 19.050 mm (0.375 x 0.750 in.)						
9.525 +0.050/+0.076	19.050 +0.051/+0.076	9.525 +/-0.127			BP00953-01905-00953-BS	Bushes - Bronze - Sintered - Unflanged
9.525 +0.050/+0.076	19.050 +0.051/+0.076	12.700 +/-0.127			BP00953-01905-01270-BS	Bushes - Bronze - Sintered - Unflanged
9.525 +0.025/+0.050	19.050 +0.051/+0.076	12.700 +/-0.127	25.40	3.18	BF00953-01905-01270-BS	Bushes - Bronze - Sintered - Flanged
9.525 +0.050/+0.076	19.050 +0.051/+0.076	19.050 +/-0.127			BP00953-01905-01905-BS	Bushes - Bronze - Sintered - Unflanged
9.525 +0.050/+0.076	19.050 +0.051/+0.076	25.400 +/-0.127			BP00953-01905-02540-BS	Bushes - Bronze - Sintered - Unflanged
9.525 +0.050/+0.076	19.050 +0.051/+0.076	31.750 +/-0.127			BP00953-01905-03175-BS	Bushes - Bronze - Sintered - Unflanged
9.525 x 22.225 mm (0.375 x 0.875 in.)						
9.525 +0.010/-0	22.225 +0.003/-0.010	7.137 +0/-0.127		24.61	BP00953-02223-00714-BSU	Bushes - Bronze - Sintered - Unflanged
10.000 x 12.000 mm (0.394 x 0.472 in.)						
10.000 -0.000/-0.015	12.000 +0.018/-0.000	6.000 +0.25/-0.25			BP01000-01200-00600-DP4	Bushes - Steel - DP4 - Split - Unflanged
10.000 -0.000/-0.028	12.000 +0.065/-0.000	6.000 +0.00/-0.30			BP01000-01200-00600-DU	Bushes - Steel - DU - Split - Unflanged
10.000 -0.000/-0.028	12.000 +0.065/-0.000	6.000 +0.00/-0.30			BP01000-01200-00600-SS6	Bushes - Stainless Steel and PTFE - Unflanged
10.000 -0.000/-0.034	12.000 +0.018/-0.000	7.000 +0.25/-0.25	18.00	0.95	BF01000-01200-00700-DUB	Bushes - Steel - DUB - Split - Flanged
10.000 -0.000/-0.034	12.000 +0.018/-0.000	7.000 +0.25/-0.25	18.00	1.00	BF01000-01200-00700-SS6	Bushes - Stainless Steel and PTFE - Flanged
10.000 -0.000/-0.034	12.000 +0.018/-0.000	7.000 +0.25/-0.25	18.00	1.00	BF01000-01200-00700-DU	Bushes - Steel - DU - Split - Flanged
10.000 -0.000/-0.015	12.000 +0.018/-0.000	7.000 +0.25/-0.25	18.00	1.00	BF01000-01200-00700-DP4	Bushes - Steel - DP4 - Split - Flanged
10.000 -0.000/-0.015	12.000 +0.018/-0.000	8.000 +0.25/-0.25			BP01000-01200-00800-DP4	Bushes - Steel - DP4 - Split - Unflanged
10.000 -0.000/-0.028	12.000 +0.065/-0.000	8.000 +0.00/-0.30			BP01000-01200-00800-DU	Bushes - Steel - DU - Split - Unflanged
10.000 -0.000/-0.028	12.000 +0.065/-0.000	8.000 +0.00/-0.30			BP01000-01200-00800-SS6	Bushes - Stainless Steel and PTFE - Unflanged
10.000 -0.000/-0.034	12.000 +0.018/-0.000	9.000 +0.25/-0.25	18.00	1.00	BF01000-01200-00900-DU	Bushes - Steel - DU - Split - Flanged

 Stocked or Short Delivery

 Usually Available

 Long delivery or not in current production

ID	OD	B	DF	bf	Part Number	Type
10.000 x 12.000 mm (0.394 x 0.472 in.)						
10.000 -0.000/-0.034	12.000 +0.018/-0.000	9.000 +0.25/-0.25	18.00	1.00	BF01000-01200-00900-SS6	Bushes - Stainless Steel and PTFE - Flanged
10.000 -0.000/-0.015	12.000 +0.018/-0.000	9.000 +0.25/-0.25	18.00	1.00	BF01000-01200-00900-DP4	Bushes - Steel - DP4 - Split - Flanged
10.000 -0.000/-0.028	12.000 +0.065/-0.000	10.000 +0.00/-0.30			BP01000-01200-01000-DU	Bushes - Steel - DU - Split - Unflanged
10.000 -0.000/-0.015	12.000 +0.018/-0.000	10.000 +0.25/-0.25			BP01000-01200-01000-DP4	Bushes - Steel - DP4 - Split - Unflanged
10.000 -0.000/-0.028	12.000 +0.065/-0.000	10.000 +0.00/-0.30			BP01000-01200-01000-SS6	Bushes - Stainless Steel and PTFE - Unflanged
10.000 -0.000/-0.028	12.000 +0.065/-0.000	10.000 +0.25/-0.25			BP01000-01200-01000-DX	Bushes - Steel - DX - Split - Unflanged
10.000 -0.000/-0.028	12.000 +0.065/-0.000	10.000 +0.25/-0.25			BP01000-01200-01000-DUB	Bushes - Steel - DUB - Split - Unflanged
10.000 -0.000/-0.028	12.000 +0.065/-0.000	12.000 +0.00/-0.30			BP01000-01200-01200-SS6	Bushes - Stainless Steel and PTFE - Unflanged
10.000 -0.000/-0.015	12.000 +0.065/-0.000	12.000 +0.25/-0.25			BP01000-01200-01200-DP4	Bushes - Steel - DP4 - Split - Unflanged
10.000 -0.000/-0.028	12.000 +0.065/-0.000	12.000 +0.00/-0.30			BP01000-01200-01200-DU	Bushes - Steel - DU - Split - Unflanged
10.000 -0.000/-0.028	12.000 +0.065/-0.000	12.000 +0.25/-0.25			BP01000-01200-01200-DX	Bushes - Steel - DX - Split - Unflanged
10.000 -0.000/-0.034	12.000 +0.018/-0.000	12.000 +0.25/-0.25	18.00	0.95	BF01000-01200-01200-DUB	Bushes - Steel - DUB - Split - Flanged
10.000 -0.000/-0.034	12.000 +0.018/-0.000	12.000 +0.25/-0.25	18.00	1.00	BF01000-01200-01200-DU	Bushes - Steel - DU - Split - Flanged
10.000 -0.000/-0.015	12.000 +0.018/-0.000	12.000 +0.25/-0.25	18.00	1.00	BF01000-01200-01200-DP4	Bushes - Steel - DP4 - Split - Flanged
10.000 -0.000/-0.034	12.000 +0.018/-0.000	12.000 +0.25/-0.25	18.00	1.00	BF01000-01200-01200-SS6	Bushes - Stainless Steel and PTFE - Flanged
10.000 -0.000/-0.028	12.000 +0.065/-0.000	15.000 +0.25/-0.25			BP01000-01200-01500-DUB	Bushes - Steel - DUB - Split - Unflanged
10.000 -0.000/-0.028	12.000 +0.065/-0.000	15.000 +0.25/-0.25			BP01000-01200-01500-DX	Bushes - Steel - DX - Split - Unflanged
10.000 -0.000/-0.028	12.000 +0.065/-0.000	15.000 +0.00/-0.30			BP01000-01200-01500-SS6	Bushes - Stainless Steel and PTFE - Unflanged
10.000 -0.000/-0.015	12.000 +0.018/-0.000	15.000 +0.25/-0.25			BP01000-01200-01500-DP4	Bushes - Steel - DP4 - Split - Unflanged
10.000 -0.000/-0.028	12.000 +0.065/-0.000	15.000 +0.00/-0.30			BP01000-01200-01500-DU	Bushes - Steel - DU - Split - Unflanged
10.000 -0.000/-0.034	12.000 +0.018/-0.000	17.000 +0.25/-0.25	18.00	1.00	BF01000-01200-01700-DU	Bushes - Steel - DU - Split - Flanged
10.000 -0.000/-0.015	12.000 +0.018/-0.000	17.000 +0.25/-0.25	18.00	1.00	BF01000-01200-01700-DP4	Bushes - Steel - DP4 - Split - Flanged
10.000 -0.000/-0.028	12.000 +0.065/-0.000	20.000 +0.00/-0.30			BP01000-01200-02000-SS6	Bushes - Stainless Steel and PTFE - Unflanged
10.000 -0.000/-0.028	12.000 +0.065/-0.000	20.000 +0.25/-0.25			BP01000-01200-02000-DX	Bushes - Steel - DX - Split - Unflanged
10.000 -0.000/-0.028	12.000 +0.065/-0.000	20.000 +0.00/-0.30			BP01000-01200-02000-DU	Bushes - Steel - DU - Split - Unflanged
10.000 -0.000/-0.015	12.000 +0.018/-0.000	20.000 +0.25/-0.25			BP01000-01200-02000-DP4	Bushes - Steel - DP4 - Split - Unflanged
10.000 +/-0.0254	12.000 +0.0508/+0.0762	20.000 +/-0.127			BP01000-01200-02000-BLG	Bushes - Bronze - Solid - Leaded Gunmetal
10.000 +/-0.0254	12.000 +0.0508/+0.0762	30.000 +/-0.127			BP01000-01200-03000-BLG	Bushes - Bronze - Solid - Leaded Gunmetal
10.000 +/-0.0254	12.000 +0.0508/+0.0762	40.000 +/-0.127			BP01000-01200-04000-BLG	Bushes - Bronze - Solid - Leaded Gunmetal
10.000 x 14.000 mm (0.394 x 0.551 in.)						
10.000 +0.005/+0.020	14.000 +0.028/+0.046	8.000 +/-0.110			BP01000-01400-00800-BSO	Bushes - Bronze - Sintered - Unflanged - Oilite
10.000 +0.025/+0.040	14.000 +0.023/+0.041	10.000 +0/-0.200			BP01000-01400-01000-BS	Bushes - Bronze - Sintered - Unflanged
10.000 +0.005/+0.020	14.000 +0.028/+0.046	10.000 +/-0.110			BP01000-01400-01000-BSO	Bushes - Bronze - Sintered - Unflanged - Oilite
10.000 +0.025/+0.040	14.000 +0.023/+0.041	16.000 +0/-0.200			BP01000-01400-01600-BS	Bushes - Bronze - Sintered - Unflanged
10.000 +0.005/+0.020	14.000 +0.028/+0.046	16.000 +/-0.130			BP01000-01400-01600-BSO	Bushes - Bronze - Sintered - Unflanged - Oilite
10.000 +0.005/+0.020	14.000 +0.028/+0.046	20.000 +/-0.160			BP01000-01400-02000-BSO	Bushes - Bronze - Sintered - Unflanged - Oilite
10.000 +0.005/+0.020	14.000 +0.028/+0.046	25.000 +/-0.160			BP01000-01400-02500-BSO	Bushes - Bronze - Sintered - Unflanged - Oilite
10.000 x 15.000 mm (0.394 x 0.591 in.)						
10.000 +0.005/+0.020	15.000 +0.028/+0.046	10.000 +/-0.110	21.00	3.00	BF01000-01500-01000-BSO	Bushes - Bronze - Sintered - Flanged - Oilite
10.000 +0.005/+0.020	15.000 +0.028/+0.046	16.000 +/-0.130	21.00	3.00	BF01000-01500-01600-BSO	Bushes - Bronze - Sintered - Flanged - Oilite

Stocked or Short Delivery

Usually Available

Long delivery or not in current production

ID	OD	B	DF	bf	Part Number	Type
10.000 x 15.000 mm (0.394 x 0.591 in.)						
10.000 +0.005/+0.020	15.000 +0.028/+0.046	20.000 +/-0.160	21.00	3.00	BF01000-01500-02000-BSO	Bushes - Bronze - Sintered - Flanged - Oilite
10.000 x 16.000 mm (0.394 x 0.630 in.)						
10.000 +0.005/+0.020	16.000 +0.028/+0.046	8.000 +/-0.110			BP01000-01600-00800-BSO	Bushes - Bronze - Sintered - Unflanged - Oilite
10.000 +0.025/+0.040	16.000 +0.023/+0.041	8.000 +0/-0.200	20.00	3.00	BF01000-01600-00800-BS	Bushes - Bronze - Sintered - Flanged
10.000 +0.005/+0.020	16.000 +0.028/+0.046	8.000 +/-0.110	22.00	3.00	BF01000-01600-00800-BSO	Bushes - Bronze - Sintered - Flanged - Oilite
10.000 +0.025/+0.040	16.000 +0.023/+0.041	10.000 +0/-0.200			BP01000-01600-01000-BS	Bushes - Bronze - Sintered - Unflanged
10.000 +0.005/+0.020	16.000 +0.028/+0.046	10.000 +/-0.110			BP01000-01600-01000-BSO	Bushes - Bronze - Sintered - Unflanged - Oilite
10.000 +0.025/+0.040	16.000 +0.023/+0.041	10.000 +0/-0.200	20.00	3.00	BF01000-01600-01000-BS	Bushes - Bronze - Sintered - Flanged
10.000 +0.005/+0.020	16.000 +0.028/+0.046	10.000 +/-0.110	22.00	3.00	BF01000-01600-01000-BSO	Bushes - Bronze - Sintered - Flanged - Oilite
10.000 +0.025/+0.040	16.000 +0.023/+0.041	16.000 +0/-0.200			BP01000-01600-01600-BS	Bushes - Bronze - Sintered - Unflanged
10.000 +0.005/+0.020	16.000 +0.028/+0.046	16.000 +/-0.130			BP01000-01600-01600-BSO	Bushes - Bronze - Sintered - Unflanged - Oilite
10.000 +0.005/+0.020	16.000 +0.028/+0.046	16.000 +/-0.130	22.00	3.00	BF01000-01600-01600-BSO	Bushes - Bronze - Sintered - Flanged - Oilite
10.000 +0.025/+0.040	16.000 +0.023/+0.041	20.000 +0/-0.200			BP01000-01600-02000-BS	Bushes - Bronze - Sintered - Unflanged
10.000 +0.005/+0.020	16.000 +0.028/+0.046	20.000 +/-0.160			BP01000-01600-02000-BSO	Bushes - Bronze - Sintered - Unflanged - Oilite
10.000 +/-0.0254	16.000 +0.0508/+0.0762	20.000 +/-0.127			BP01000-01600-02000-BLG	Bushes - Bronze - Solid - Leaded Gunmetal
10.000 +0.005/+0.020	16.000 +0.028/+0.046	25.000 +/-0.160			BP01000-01600-02500-BSO	Bushes - Bronze - Sintered - Unflanged - Oilite
10.000 +/-0.0254	16.000 +0.0508/+0.0762	30.000 +/-0.127			BP01000-01600-03000-BLG	Bushes - Bronze - Solid - Leaded Gunmetal
10.000 +/-0.0254	16.000 +0.0508/+0.0762	40.000 +/-0.127			BP01000-01600-04000-BLG	Bushes - Bronze - Solid - Leaded Gunmetal
10.000 +/-0.0254	16.000 +0.0508/+0.0762	50.000 +/-0.127			BP01000-01600-05000-BLG	Bushes - Bronze - Solid - Leaded Gunmetal
10.000 x 19.000 mm (0.394 x 0.748 in.)						
10.000 +0.015/-0	19.000 +0/-0.013	7.000 +0/-0.170			BP01000-01900-00700-BS	Bushes - Bronze - Sintered - Unflanged
10.000 +0.015/-0	19.000 +0/-0.013	7.000 +0/-0.178	21.00	1.50	BF01000-01900-00700-BS	Bushes - Bronze - Sintered - Flanged
11.113 x 12.700 mm (0.438 x 0.500 in.)						
11.113 +0.025/+0.051	12.700 +0.077/+0.102	3.912 +/-0.127	14.27	1.96	BF01111-01270-00391-BS	Bushes - Bronze - Sintered - Flanged
11.113 x 13.494 mm (0.438 x 0.531 in.)						
11.113 -0.025/-0.051	13.494 +0.009/-0.009	12.700 +0.00/-0.30			BP01111-01349-01270-DU	Bushes - Steel - DU - Split - Unflanged
11.113 -0.025/-0.051	13.494 +0.009/-0.009	12.700 +0.25/-0.25			BP01111-01349-01270-SS6	Bushes - Stainless Steel and PTFE - Unflanged
11.113 -0.025/-0.051	13.494 +0.009/-0.009	12.700 +0.00/-0.30			BP01111-01349-01270-DP4	Bushes - Steel - DP4 - Split - Unflanged
11.113 -0.025/-0.051	13.494 +0.009/-0.009	19.050 +0.00/-0.30			BP01111-01349-01905-DU	Bushes - Steel - DU - Split - Unflanged
11.113 -0.025/-0.051	13.494 +0.009/-0.009	19.050 +0.25/-0.25			BP01111-01349-01905-SS6	Bushes - Stainless Steel and PTFE - Unflanged
11.113 -0.025/-0.051	13.494 +0.009/-0.009	19.050 +0.00/-0.30			BP01111-01349-01905-DP4	Bushes - Steel - DP4 - Split - Unflanged
11.113 x 14.288 mm (0.438 x 0.563 in.)						
11.113 +0.025/+0.051	14.288 +0.052/+0.077	7.137 +/-0.127	19.84	1.65	BF01111-01429-00714-BS	Bushes - Bronze - Sintered - Flanged
11.113 +0.050/+0.076	14.288 +0.039/+0.064	9.525 +/-0.127			BP01111-01429-00953-BS	Bushes - Bronze - Sintered - Unflanged
11.113 +0.007/+0.025	14.288 +0.027/+0.045	9.525 +/-0.110			BP01111-01429-00953-BSO	Bushes - Bronze - Sintered - Unflanged - Oilite
11.113 +0.050/+0.076	14.288 +0.039/+0.064	12.700 +/-0.127			BP01111-01429-01270-BS	Bushes - Bronze - Sintered - Unflanged
11.113 +0.007/+0.025	14.288 +0.027/+0.045	12.700 +/-0.130			BP01111-01429-01270-BSO	Bushes - Bronze - Sintered - Unflanged - Oilite
11.113 +0.025/+0.051	14.288 +0.052/+0.077	13.868 +/-0.127	19.84	1.65	BF01111-01429-01387-BS	Bushes - Bronze - Sintered - Flanged
11.113 +0.007/+0.025	14.288 +0.027/+0.045	15.875 +/-0.130			BP01111-01429-01588-BSO	Bushes - Bronze - Sintered - Unflanged - Oilite

Stocked or Short Delivery

Usually Available

Long delivery or not in current production

ID	OD	B	DF	bf	Part Number	Type
11.113 x 14.288 mm (0.438 x 0.563 in.)						
11.113 +0.050/+0.076	14.288 +0.039/+0.064	15.875 +/-0.127			BP01111-01429-01588-BS	Bushes - Bronze - Sintered - Unflanged
11.113 +0.013/+0.038	14.288 +0.039/+0.064	15.875 +/-0.127	17.46	1.59	BF01111-01429-01588-BS	Bushes - Bronze - Sintered - Flanged
11.113 +0.025/+0.050	14.288 +0.052/+0.077	18.110 +/-0.127			BP01111-01429-01811-BS	Bushes - Bronze - Sintered - Unflanged
11.113 +0.050/+0.076	14.288 +0.039/+0.064	19.050 +/-0.127			BP01111-01429-01905-BS	Bushes - Bronze - Sintered - Unflanged
11.113 +0.007/+0.025	14.288 +0.027/+0.045	19.050 +/-0.160			BP01111-01429-01905-BSO	Bushes - Bronze - Sintered - Unflanged - Oilite
11.113 +/-0.0254	14.288 +0.0508/+0.0762	19.050 +/-0.127			BP01111-01429-01905-BLG	Bushes - Bronze - Solid - Leaded Gunmetal
11.113 +0.050/+0.076	14.288 +0.039/+0.064	22.225 +/-0.127			BP01111-01429-02223-BS	Bushes - Bronze - Sintered - Unflanged
11.113 +0.050/+0.076	14.288 +0.039/+0.064	25.400 +/-0.127			BP01111-01429-02540-BS	Bushes - Bronze - Sintered - Unflanged
11.113 +/-0.0254	14.288 +0.0508/+0.0762	25.400 +/-0.127			BP01111-01429-02540-BC9	Bushes - Bronze - Solid - Leaded Gunmetal
11.113 +/-0.0254	14.288 +0.0508/+0.0762	25.400 +/-0.127			BP01111-01429-02540-BLG	Bushes - Bronze - Solid - Leaded Gunmetal
11.113 +0.050/+0.076	14.288 +0.039/+0.064	31.750 +/-0.127			BP01111-01429-03175-BS	Bushes - Bronze - Sintered - Unflanged
11.113 +/-0.0254	14.288 +0.0508/+0.0762	38.100 +/-0.127			BP01111-01429-03810-BLG	Bushes - Bronze - Solid - Leaded Gunmetal
11.113 +/-0.0254	14.288 +0.0508/+0.0762	50.800 +/-0.127			BP01111-01429-05080-BLG	Bushes - Bronze - Solid - Leaded Gunmetal
11.113 x 15.875 mm (0.438 x 0.625 in.)						
11.113 +0.025/+0.050	15.875 +0.051/+0.076	9.525 +/-0.127			BP01111-01588-00953-BS	Bushes - Bronze - Sintered - Unflanged
11.113 +0.025/+0.050	15.875 +0.051/+0.076	12.700 +/-0.127			BP01111-01588-01270-BS	Bushes - Bronze - Sintered - Unflanged
11.113 +0.0254/+0.0508	15.875 +0.0508/+0.0762	12.700 +0.127/-0.127			BP01111-01588-01270-BFG	Bushes - Bronze - Sintered - ECO841 Food Grade - Unflanged
11.113 +0.025/+0.050	15.875 +0.051/+0.076	15.875 +/-0.127			BP01111-01588-01588-BS	Bushes - Bronze - Sintered - Unflanged
11.113 +0.025/+0.050	15.875 +0.051/+0.076	15.875 +/-0.127	22.23	3.18	BF01111-01588-01588-BS	Bushes - Bronze - Sintered - Flanged
11.113 +0.038/+0.063	15.875 +0.025/+0.050	19.050 +0.00/-0.51			BP01111-01588-01905-AF	Bushes - Aluminium - Frelon Lined - Unflanged
11.113 +0.025/+0.050	15.875 +0.051/+0.076	19.050 +/-0.127			BP01111-01588-01905-BS	Bushes - Bronze - Sintered - Unflanged
11.113 +0.0254/+0.0508	15.875 +0.0508/+0.0762	19.050 +0.127/-0.127			BP01111-01588-01905-BFG	Bushes - Bronze - Sintered - ECO841 Food Grade - Unflanged
11.113 +0.038/+0.063	15.875 +0.025/+0.050	19.050 +0.00/-0.51	23.83	3.18	BF01111-01588-01905-AF	Bushes - Aluminium - Frelon Lined - Flanged
11.113 +0.025/+0.050	15.875 +0.051/+0.076	22.225 +/-0.127			BP01111-01588-02223-BS	Bushes - Bronze - Sintered - Unflanged
11.113 +0.025/+0.050	15.875 +0.051/+0.076	25.400 +/-0.127			BP01111-01588-02540-BS	Bushes - Bronze - Sintered - Unflanged
11.113 +0.0254/+0.0508	15.875 +0.0508/+0.0762	25.400 +0.127/-0.127			BP01111-01588-02540-BFG	Bushes - Bronze - Sintered - ECO841 Food Grade - Unflanged
11.113 +/-0.0254	15.875 +0.0508/+0.0762	25.400 +/-0.127			BP01111-01588-02540-BLG	Bushes - Bronze - Solid - Leaded Gunmetal
11.113 +0.025/+0.050	15.875 +0.051/+0.076	31.750 +/-0.127			BP01111-01588-03175-BS	Bushes - Bronze - Sintered - Unflanged
11.113 +0.025/+0.050	15.875 +0.051/+0.076	31.750 +/-0.127	22.23	3.18	BF01111-01588-03175-BS	Bushes - Bronze - Sintered - Flanged
11.113 +0.025/+0.050	15.875 +0.051/+0.076	38.100 +/-0.127			BP01111-01588-03810-BS	Bushes - Bronze - Sintered - Unflanged
11.113 +/-0.0254	15.875 +0.0508/+0.0762	38.100 +/-0.127			BP01111-01588-03810-BLG	Bushes - Bronze - Solid - Leaded Gunmetal
11.113 +/-0.0254	15.875 +0.0508/+0.0762	50.800 +/-0.127			BP01111-01588-05080-BLG	Bushes - Bronze - Solid - Leaded Gunmetal
11.113 x 17.463 mm (0.438 x 0.688 in.)						
11.113 +0.025/+0.050	17.463 +0.052/+0.077	12.700 +/-0.127			BP01111-01746-01270-BS	Bushes - Bronze - Sintered - Unflanged
11.113 +0.025/+0.050	17.463 +0.052/+0.077	25.400 +/-0.127			BP01111-01746-02540-BS	Bushes - Bronze - Sintered - Unflanged
11.113 +/-0.0254	17.463 +0.0508/+0.0762	25.400 +/-0.127			BP01111-01746-02540-BLG	Bushes - Bronze - Solid - Leaded Gunmetal
11.113 +0.025/+0.050	17.463 +0.052/+0.077	38.100 +/-0.127			BP01111-01746-03810-BS	Bushes - Bronze - Sintered - Unflanged
11.113 +/-0.0254	17.463 +0.0508/+0.0762	38.100 +/-0.127			BP01111-01746-03810-BLG	Bushes - Bronze - Solid - Leaded Gunmetal
11.113 +/-0.0254	17.463 +0.0508/+0.0762	50.800 +/-0.127			BP01111-01746-05080-BLG	Bushes - Bronze - Solid - Leaded Gunmetal

 Stocked or Short Delivery

 Usually Available

 Long delivery or not in current production

ID	OD	B	DF	bf	Part Number	Type
11.113 x 19.050 mm (0.438 x 0.750 in.)						
11.113 +0.025/+0.051	19.050 +0.077/+0.102	15.875 +/-0.127	22.23	1.65	BF01111-01905-01588-BS	Bushes - Bronze - Sintered - Flanged
12.000 x 14.000 mm (0.472 x 0.551 in.)						
12.000 -0.000/-0.034	14.000 +0.065/-0.000	6.000 +0.00/-0.30			BP01200-01400-00600-SS6	Bushes - Stainless Steel and PTFE - Unflanged
12.000 -0.000/-0.018	14.000 +0.018/-0.000	6.000 +0.25/-0.25			BP01200-01400-00600-DP4	Bushes - Steel - DP4 - Split - Unflanged
12.000 -0.000/-0.034	14.000 +0.065/-0.000	6.000 +0.00/-0.30			BP01200-01400-00600-DU	Bushes - Steel - DU - Split - Unflanged
12.000 -0.000/-0.034	14.000 +0.018/-0.000	7.000 +0.25/-0.25	20.00	0.95	BF01200-01400-00700-DUB	Bushes - Steel - DUB - Split - Flanged
12.000 -0.000/-0.034	14.000 +0.018/-0.000	7.000 +0.25/-0.25	20.00	1.00	BF01200-01400-00700-SS6	Bushes - Stainless Steel and PTFE - Flanged
12.000 -0.000/-0.034	14.000 +0.018/-0.000	7.000 +0.25/-0.25	20.00	1.00	BF01200-01400-00700-DU	Bushes - Steel - DU - Split - Flanged
12.000 -0.000/-0.018	14.000 +0.018/-0.000	7.000 +0.25/-0.25	20.00	1.00	BF01200-01400-00700-DP4	Bushes - Steel - DP4 - Split - Flanged
12.000 -0.000/-0.034	14.000 +0.065/-0.000	8.000 +0.25/-0.25			BP01200-01400-00800-DUB	Bushes - Steel - DUB - Split - Unflanged
12.000 -0.000/-0.018	14.000 +0.018/-0.000	8.000 +0.25/-0.25			BP01200-01400-00800-DP4	Bushes - Steel - DP4 - Split - Unflanged
12.000 -0.000/-0.034	14.000 +0.065/-0.000	8.000 +0.00/-0.30			BP01200-01400-00800-DU	Bushes - Steel - DU - Split - Unflanged
12.000 -0.000/-0.034	14.000 +0.065/-0.000	8.000 +0.00/-0.30			BP01200-01400-00800-SS6	Bushes - Stainless Steel and PTFE - Unflanged
12.000 -0.000/-0.034	14.000 +0.018/-0.000	9.000 +0.25/-0.25	20.00	0.95	BF01200-01400-00900-DUB	Bushes - Steel - DUB - Split - Flanged
12.000 -0.000/-0.034	14.000 +0.065/-0.000	9.000 +0.25/-0.25	20.00	1.00	BF01200-01400-00900-SS6	Bushes - Stainless Steel and PTFE - Flanged
12.000 -0.000/-0.018	14.000 +0.018/-0.000	9.000 +0.25/-0.25	20.00	1.00	BF01200-01400-00900-DP4	Bushes - Steel - DP4 - Split - Flanged
12.000 -0.000/-0.034	14.000 +0.018/-0.000	9.000 +0.25/-0.25	20.00	1.00	BF01200-01400-00900-DU	Bushes - Steel - DU - Split - Flanged
12.000 -0.000/-0.034	14.000 +0.065/-0.000	10.000 +0.00/-0.30			BP01200-01400-01000-DU	Bushes - Steel - DU - Split - Unflanged
12.000 -0.000/-0.018	14.000 +0.018/-0.000	10.000 +0.25/-0.25			BP01200-01400-01000-DP4	Bushes - Steel - DP4 - Split - Unflanged
12.000 -0.000/-0.034	14.000 +0.065/-0.000	10.000 +0.25/-0.25			BP01200-01400-01000-DX	Bushes - Steel - DX - Split - Unflanged
12.000 -0.000/-0.034	14.000 +0.065/-0.000	10.000 +0.00/-0.30			BP01200-01400-01000-SS6	Bushes - Stainless Steel and PTFE - Unflanged
12.000 -0.000/-0.034	14.000 +0.065/-0.000	10.000 +0.25/-0.25			BP01200-01400-01000-DUB	Bushes - Steel - DUB - Split - Unflanged
12.000 -0.000/-0.034	14.000 +0.065/-0.000	12.000 +0.00/-0.30			BP01200-01400-01200-DU	Bushes - Steel - DU - Split - Unflanged
12.000 -0.000/-0.034	14.000 +0.065/-0.000	12.000 +0.00/-0.30			BP01200-01400-01200-SS6	Bushes - Stainless Steel and PTFE - Unflanged
12.000 -0.000/-0.018	14.000 +0.018/-0.000	12.000 +0.25/-0.25			BP01200-01400-01200-DP4	Bushes - Steel - DP4 - Split - Unflanged
12.000 -0.000/-0.034	14.000 +0.065/-0.000	12.000 +0.25/-0.25			BP01200-01400-01200-DX	Bushes - Steel - DX - Split - Unflanged
12.000 -0.000/-0.034	14.000 +0.065/-0.000	12.000 +0.25/-0.25			BP01200-01400-01200-DUB	Bushes - Steel - DUB - Split - Unflanged
12.000 -0.000/-0.034	14.000 +0.018/-0.000	12.000 +0.25/-0.25	20.00	0.95	BF01200-01400-01200-DUB	Bushes - Steel - DUB - Split - Flanged
12.000 -0.000/-0.034	14.000 +0.018/-0.000	12.000 +0.25/-0.25	20.00	1.00	BF01200-01400-01200-SS6	Bushes - Stainless Steel and PTFE - Flanged
12.000 -0.000/-0.034	14.000 +0.018/-0.000	12.000 +0.25/-0.25	20.00	1.00	BF01200-01400-01200-DU	Bushes - Steel - DU - Split - Flanged
12.000 -0.000/-0.018	14.000 +0.018/-0.000	12.000 +0.25/-0.25	20.00	1.00	BF01200-01400-01200-DP4	Bushes - Steel - DP4 - Split - Flanged
12.000 -0.000/-0.034	14.000 +0.065/-0.000	15.000 +0.25/-0.25			BP01200-01400-01500-DX	Bushes - Steel - DX - Split - Unflanged
12.000 -0.000/-0.034	14.000 +0.065/-0.000	15.000 +0.00/-0.30			BP01200-01400-01500-SS6	Bushes - Stainless Steel and PTFE - Unflanged
12.000 -0.000/-0.018	14.000 +0.018/-0.000	15.000 +0.25/-0.25			BP01200-01400-01500-DP4	Bushes - Steel - DP4 - Split - Unflanged
12.000 -0.000/-0.034	14.000 +0.065/-0.000	15.000 +0.25/-0.25			BP01200-01400-01500-DUB	Bushes - Steel - DUB - Split - Unflanged
12.000 -0.000/-0.034	14.000 +0.065/-0.000	15.000 +0.00/-0.30			BP01200-01400-01500-DU	Bushes - Steel - DU - Split - Unflanged
12.000 -0.000/-0.034	14.000 +0.018/-0.000	17.000 +0.25/-0.25	20.00	1.00	BF01200-01400-01700-DU	Bushes - Steel - DU - Split - Flanged
12.000 -0.000/-0.018	14.000 +0.018/-0.000	17.000 +0.25/-0.25	20.00	1.00	BF01200-01400-01700-DP4	Bushes - Steel - DP4 - Split - Flanged
12.000 -0.000/-0.034	14.000 +0.065/-0.000	20.000 +0.25/-0.25			BP01200-01400-02000-DX	Bushes - Steel - DX - Split - Unflanged
12.000 -0.000/-0.034	14.000 +0.065/-0.000	20.000 +0.00/-0.30			BP01200-01400-02000-SS6	Bushes - Stainless Steel and PTFE - Unflanged
12.000 -0.000/-0.034	14.000 +0.065/-0.000	20.000 +0.00/-0.30			BP01200-01400-02000-DU	Bushes - Steel - DU - Split - Unflanged

 Stocked or Short Delivery

 Usually Available

 Long delivery or not in current production

ID	OD	B	DF	bf	Part Number	Type
12.000 x 14.000 mm (0.472 x 0.551 in.)						
12.000 -0.000/-0.018	14.000 +0.018/-0.000	20.000 +0.25/-0.25			BP01200-01400-02000-DP4	Bushes - Steel - DP4 - Split - Unflanged
12.000 -0.000/-0.034	14.000 +0.065/-0.000	25.000 +0.00/-0.30			BP01200-01400-02500-SS6	Bushes - Stainless Steel and PTFE - Unflanged
12.000 -0.000/-0.018	14.000 +0.018/-0.000	25.000 +0.25/-0.25			BP01200-01400-02500-DP4	Bushes - Steel - DP4 - Split - Unflanged
12.000 -0.000/-0.034	14.000 +0.065/-0.000	25.000 +0.00/-0.30			BP01200-01400-02500-DU	Bushes - Steel - DU - Split - Unflanged
12.000 -0.000/-0.034	14.000 +0.065/-0.000	25.000 +0.25/-0.25			BP01200-01400-02500-DX	Bushes - Steel - DX - Split - Unflanged
12.000 x 15.000 mm (0.472 x 0.591 in.)						
12.000 +0.006/+0.024	15.000 +0.028/+0.046	12.000 +/-0.130	21.00	3.00	BF01200-01500-01200-BSO	Bushes - Bronze - Sintered - Flanged - Oilite
12.000 +0.006/+0.024	15.000 +0.028/+0.046	16.000 +/-0.130	21.00	3.00	BF01200-01500-01600-BSO	Bushes - Bronze - Sintered - Flanged - Oilite
12.000 +0.006/+0.024	15.000 +0.028/+0.046	20.000 +/-0.160	21.00	3.00	BF01200-01500-02000-BSO	Bushes - Bronze - Sintered - Flanged - Oilite
12.000 x 16.000 mm (0.472 x 0.630 in.)						
12.000 +0.006/+0.024	16.000 +0.028/+0.046	8.000 +/-0.110			BP01200-01600-00800-BSO	Bushes - Bronze - Sintered - Unflanged - Oilite
12.000 +0.025/+0.050	16.000 +0.023/+0.041	12.000 +0/-0.200			BP01200-01600-01200-BS	Bushes - Bronze - Sintered - Unflanged
12.000 +0.006/+0.024	16.000 +0.028/+0.046	12.000 +/-0.130			BP01200-01600-01200-BSO	Bushes - Bronze - Sintered - Unflanged - Oilite
12.000 +0.006/+0.024	16.000 +0.028/+0.046	16.000 +/-0.130			BP01200-01600-01600-BSO	Bushes - Bronze - Sintered - Unflanged - Oilite
12.000 +0.025/+0.050	16.000 +0.023/+0.041	20.000 +0/-0.200			BP01200-01600-02000-BS	Bushes - Bronze - Sintered - Unflanged
12.000 +0.006/+0.024	16.000 +0.028/+0.046	20.000 +/-0.160			BP01200-01600-02000-BSO	Bushes - Bronze - Sintered - Unflanged - Oilite
12.000 +/-0.0254	16.000 +0.0508/+0.0762	20.000 +/-0.127			BP01200-01600-02000-BLG	Bushes - Bronze - Solid - Leaded Gunmetal
12.000 +0.006/+0.024	16.000 +0.028/+0.046	25.000 +/-0.160			BP01200-01600-02500-BSO	Bushes - Bronze - Sintered - Unflanged - Oilite
12.000 +/-0.0254	16.000 +0.0508/+0.0762	30.000 +/-0.127			BP01200-01600-03000-BLG	Bushes - Bronze - Solid - Leaded Gunmetal
12.000 +/-0.0254	16.000 +0.0508/+0.0762	40.000 +/-0.127			BP01200-01600-04000-BLG	Bushes - Bronze - Solid - Leaded Gunmetal
12.000 +/-0.0254	16.000 +0.0508/+0.0762	50.000 +/-0.127			BP01200-01600-05000-BLG	Bushes - Bronze - Solid - Leaded Gunmetal
12.000 x 18.000 mm (0.472 x 0.709 in.)						
12.000 +0.006/+0.024	18.000 +0.028/+0.046	8.000 +/-0.110			BP01200-01800-00800-BSO	Bushes - Bronze - Sintered - Unflanged - Oilite
12.000 +0.006/+0.024	18.000 +0.028/+0.046	8.000 +/-0.110	24.00	3.00	BF01200-01800-00800-BSO	Bushes - Bronze - Sintered - Flanged - Oilite
12.000 +0.025/+0.040	18.000 +0.023/+0.041	10.000 +0/-0.200	22.00	3.00	BF01200-01800-01000-BS	Bushes - Bronze - Sintered - Flanged
12.000 +0.025/+0.050	18.000 +0.023/+0.041	12.000 +0/-0.200			BP01200-01800-01200-BS	Bushes - Bronze - Sintered - Unflanged
12.000 +0.006/+0.024	18.000 +0.028/+0.046	12.000 +/-0.130			BP01200-01800-01200-BSO	Bushes - Bronze - Sintered - Unflanged - Oilite
12.000 +0.032/+0.050	18.000 +0.023/+0.041	12.000 +0/-0.200	22.00	3.00	BF01200-01800-01200-BS	Bushes - Bronze - Sintered - Flanged
12.000 +0.006/+0.024	18.000 +0.028/+0.046	12.000 +/-0.130	24.00	3.00	BF01200-01800-01200-BSO	Bushes - Bronze - Sintered - Flanged - Oilite
12.000 +0.025/+0.050	18.000 +0.023/+0.041	16.000 +0/-0.200			BP01200-01800-01600-BS	Bushes - Bronze - Sintered - Unflanged
12.000 +0.006/+0.024	18.000 +0.028/+0.046	16.000 +/-0.130			BP01200-01800-01600-BSO	Bushes - Bronze - Sintered - Unflanged - Oilite
12.000 +0.006/+0.024	18.000 +0.028/+0.046	20.000 +/-0.160			BP01200-01800-02000-BSO	Bushes - Bronze - Sintered - Unflanged - Oilite
12.000 +0.006/+0.024	18.000 +0.028/+0.046	20.000 +/-0.160	24.00	3.00	BF01200-01800-02000-BSO	Bushes - Bronze - Sintered - Flanged - Oilite
12.000 +0.025/+0.050	18.000 +0.023/+0.041	25.000 +0/-0.200			BP01200-01800-02500-BS	Bushes - Bronze - Sintered - Unflanged
12.000 +0.006/+0.024	18.000 +0.028/+0.046	25.000 +/-0.160			BP01200-01800-02500-BSO	Bushes - Bronze - Sintered - Unflanged - Oilite
12.000 x 20.000 mm (0.472 x 0.787 in.)						
12.000 +0.018/+0	20.000 +0/-0.013	8.000 +0/-0.170			BP01200-02000-00800-BS	Bushes - Bronze - Sintered - Unflanged
12.000 +0.018/+0	20.000 +0/-0.013	8.000 +0/-0.178	22.00	1.50	BF01200-02000-00800-BS	Bushes - Bronze - Sintered - Flanged
12.000 +/-0.0254	20.000 +0.0508/+0.0762	20.000 +/-0.127			BP01200-02000-02000-BLG	Bushes - Bronze - Solid - Leaded Gunmetal
12.000 +/-0.0254	20.000 +0.0508/+0.0762	30.000 +/-0.127			BP01200-02000-03000-BLG	Bushes - Bronze - Solid - Leaded Gunmetal

 Stocked or Short Delivery

 Usually Available

 Long delivery or not in current production

ID	OD	B	DF	bf	Part Number	Type
12.000 x 20.000 mm (0.472 x 0.787 in.)						
12.000 +/-0.0254	20.000 +0.0508/+0.0762	40.000 +/-0.127			BP01200-02000-04000-BLG	Bushes - Bronze - Solid - Leaded Gunmetal
12.000 +/-0.0254	20.000 +0.0508/+0.0762	50.000 +/-0.127			BP01200-02000-05000-BLG	Bushes - Bronze - Solid - Leaded Gunmetal
12.700 x 14.288 mm (0.500 x 0.563 in.)						
12.700 +/-0.0254	14.288 +0.0508/+0.0762	38.100 +/-0.127			BP01270-01429-03810-BLG	Bushes - Bronze - Solid - Leaded Gunmetal
12.700 x 15.081 mm (0.500 x 0.594 in.)						
12.700 -0.025/-0.051	15.081 +0.009/-0.009	6.350 +0.00/-0.30			BP01270-01508-00635-DP4	Bushes - Steel - DP4 - Split - Unflanged
12.700 -0.025/-0.051	15.081 +0.009/-0.009	6.350 +0.00/-0.30			BP01270-01508-00635-DU	Bushes - Steel - DU - Split - Unflanged
12.700 -0.025/-0.051	15.081 +0.009/-0.009	6.350 +0.25/-0.25			BP01270-01508-00635-SS6	Bushes - Stainless Steel and PTFE - Unflanged
12.700 -0.025/-0.051	15.081 +0.009/-0.009	6.350 +0.25/-0.25	21.15	1.32	BF01270-01508-00635-DU	Bushes - Steel - DU - Split - Flanged
12.700 -0.025/-0.051	15.081 +0.009/-0.009	6.350 +0.25/-0.25	21.15	1.32	BF01270-01508-00635-DP4	Bushes - Steel - DP4 - Split - Flanged
12.700 -0.025/-0.051	15.081 +0.009/-0.009	6.350 +0.25/-0.25	21.15	1.32	BF01270-01508-00635-SS6	Bushes - Stainless Steel and PTFE - Flanged
12.700 -0.025/-0.051	15.081 +0.009/-0.009	9.525 +0.25/-0.25			BP01270-01508-00953-SS6	Bushes - Stainless Steel and PTFE - Unflanged
12.700 -0.025/-0.051	15.081 +0.009/-0.009	9.525 +0.00/-0.30			BP01270-01508-00953-DP4	Bushes - Steel - DP4 - Split - Unflanged
12.700 -0.025/-0.051	15.081 +0.009/-0.009	9.525 +0.00/-0.30			BP01270-01508-00953-DU	Bushes - Steel - DU - Split - Unflanged
12.700 -0.025/-0.051	15.081 +0.009/-0.009	9.525 +0.25/-0.25	21.15	1.32	BF01270-01508-00953-SS6	Bushes - Stainless Steel and PTFE - Flanged
12.700 -0.025/-0.051	15.081 +0.009/-0.009	9.525 +0.25/-0.25	21.15	1.32	BF01270-01508-00953-DU	Bushes - Steel - DU - Split - Flanged
12.700 -0.025/-0.051	15.081 +0.009/-0.009	9.525 +0.25/-0.25	21.15	1.32	BF01270-01508-00953-DP4	Bushes - Steel - DP4 - Split - Flanged
12.700 -0.025/-0.051	15.081 +0.009/-0.009	12.700 +0.00/-0.30			BP01270-01508-01270-DU	Bushes - Steel - DU - Split - Unflanged
12.700 -0.025/-0.051	15.081 +0.009/-0.009	12.700 +0.00/-0.30			BP01270-01508-01270-DP4	Bushes - Steel - DP4 - Split - Unflanged
12.700 -0.025/-0.051	15.081 +0.009/-0.009	12.700 +0.25/-0.25			BP01270-01508-01270-SS6	Bushes - Stainless Steel and PTFE - Unflanged
12.700 -0.025/-0.051	15.081 +0.009/-0.009	12.700 +0.25/-0.25	21.15	1.32	BF01270-01508-01270-DP4	Bushes - Steel - DP4 - Split - Flanged
12.700 -0.025/-0.051	15.081 +0.009/-0.009	12.700 +0.25/-0.25	21.15	1.32	BF01270-01508-01270-DU	Bushes - Steel - DU - Split - Flanged
12.700 -0.025/-0.051	15.081 +0.009/-0.009	12.700 +0.25/-0.25	21.15	1.32	BF01270-01508-01270-SS6	Bushes - Stainless Steel and PTFE - Flanged
12.700 -0.025/-0.051	15.081 +0.009/-0.009	15.875 +0.00/-0.30			BP01270-01508-01588-DU	Bushes - Steel - DU - Split - Unflanged
12.700 -0.025/-0.051	15.081 +0.009/-0.009	15.875 +0.00/-0.30			BP01270-01508-01588-DP4	Bushes - Steel - DP4 - Split - Unflanged
12.700 -0.025/-0.051	15.081 +0.009/-0.009	15.875 +0.25/-0.25			BP01270-01508-01588-SS6	Bushes - Stainless Steel and PTFE - Unflanged
12.700 -0.025/-0.051	15.081 +0.009/-0.009	19.050 +0.00/-0.30			BP01270-01508-01905-DU	Bushes - Steel - DU - Split - Unflanged
12.700 -0.025/-0.051	15.081 +0.009/-0.009	19.050 +0.00/-0.30			BP01270-01508-01905-DP4	Bushes - Steel - DP4 - Split - Unflanged
12.700 -0.025/-0.051	15.081 +0.009/-0.009	19.050 +0.25/-0.25			BP01270-01508-01905-SS6	Bushes - Stainless Steel and PTFE - Unflanged
12.700 -0.025/-0.051	15.081 +0.009/-0.009	19.050 +0.25/-0.25	21.15	1.32	BF01270-01508-01905-SS6	Bushes - Stainless Steel and PTFE - Flanged
12.700 -0.025/-0.051	15.081 +0.009/-0.009	19.050 +0.25/-0.25	21.15	1.32	BF01270-01508-01905-DU	Bushes - Steel - DU - Split - Flanged
12.700 -0.025/-0.051	15.081 +0.009/-0.009	19.050 +0.25/-0.25	21.15	1.32	BF01270-01508-01905-DP4	Bushes - Steel - DP4 - Split - Flanged
12.700 -0.025/-0.051	15.081 +0.009/-0.009	22.225 +0.00/-0.30			BP01270-01508-02223-DU	Bushes - Steel - DU - Split - Unflanged
12.700 -0.025/-0.051	15.081 +0.009/-0.009	22.225 +0.00/-0.30			BP01270-01508-02223-DP4	Bushes - Steel - DP4 - Split - Unflanged
12.700 -0.025/-0.051	15.081 +0.009/-0.009	22.225 +0.25/-0.25			BP01270-01508-02223-SS6	Bushes - Stainless Steel and PTFE - Unflanged
12.700 x 15.875 mm (0.500 x 0.625 in.)						
12.700 +0.025/+0.051	15.875 +0.077/+0.102	3.531 +0/-0.076	22.23	1.27	BF01270-01588-00353-BS	Bushes - Bronze - Sintered - Flanged
12.700 +0.025/+0.051	15.875 +0.051/+0.076	5.029 +0/-0.152	22.10	1.07	BF01270-01588-00503-BS	Bushes - Bronze - Sintered - Flanged
12.700 +0.025/+0.051	15.875 +0.077/+0.102	6.350 +/-0.127	20.62	2.41	BF01270-01588-00635-BS	Bushes - Bronze - Sintered - Flanged
12.700 +0.025/+0.051	15.875 +0.077/+0.102	7.798 +/-0.127	22.23	1.65	BF01270-01588-00780-BS	Bushes - Bronze - Sintered - Flanged

 Stocked or Short Delivery

 Usually Available

 Long delivery or not in current production

ID	OD	B	DF	bf	Part Number	Type
12.700 x 15.875 mm (0.500 x 0.625 in.)						
12.700 +0.050/+0.076	15.875 +0.051/+0.076	9.525 +/-0.127			BP01270-01588-00953-BS08	Bushes - Bronze - Sintered - Unflanged
12.700 +0.025/+0.050	15.875 +0.051/+0.076	9.525 +/-0.127			BP01270-01588-00953-BS05	Bushes - Bronze - Sintered - Unflanged
12.700 +0.0254/+0.0508	15.875 +0.0508/+0.0762	9.525 +0.127/-0.127			BP01270-01588-00953-BFG	Bushes - Bronze - Sintered - ECO841 Food Grade - Unflanged
12.700 +0.025/+0.050	15.875 +0.051/+0.076	9.525 +/-0.127	22.23	3.18	BF01270-01588-00953-BS	Bushes - Bronze - Sintered - Flanged
12.700 +0.050/+0.076	15.875 +0.051/+0.076	10.617 +0/-0.102			BP01270-01588-01062-BS	Bushes - Bronze - Sintered - Unflanged
12.700 +0.050/+0.076	15.875 +0.051/+0.076	11.100 +/-0.127			BP01270-01588-01110-BS	Bushes - Bronze - Sintered - Unflanged
12.700 +0.050/+0.076	15.875 +0.051/+0.076	12.700 +/-0.127			BP01270-01588-01270-BS08	Bushes - Bronze - Sintered - Unflanged
12.700 +0.025/+0.050	15.875 +0.051/+0.076	12.700 +/-0.127			BP01270-01588-01270-BS05	Bushes - Bronze - Sintered - Unflanged
12.700 +0.006/+0.024	15.875 +0.028/+0.046	12.700 +/-0.130			BP01270-01588-01270-BSO	Bushes - Bronze - Sintered - Unflanged - Oilite
12.700 +0.0254/+0.0508	15.875 +0.0508/+0.0762	12.700 +0.127/-0.127			BP01270-01588-01270-BFG	Bushes - Bronze - Sintered - ECO841 Food Grade - Unflanged
12.700 +0.006/+0.024	15.875 +0.028/+0.046	12.700 +/-0.130	19.05	2.49	BF01270-01588-01270-BSO	Bushes - Bronze - Sintered - Flanged - Oilite
12.700 +0.025/+0.051	15.875 +0.026/+0.051	12.700 +/-0.127	22.23	1.59	BF01270-01588-01270-BS05	Bushes - Bronze - Sintered - Flanged
12.700 +0.025/+0.050	15.875 +0.051/+0.076	12.700 +/-0.127	22.23	3.18	BF01270-01588-01270-BS06	Bushes - Bronze - Sintered - Flanged
12.700 +0.025/+0.051	15.875 +0.077/+0.102	14.275 +/-0.127	22.23	1.65	BF01270-01588-01428-BS	Bushes - Bronze - Sintered - Flanged
12.700 +0.050/+0.076	15.875 +0.051/+0.076	15.062 +/-0.127			BP01270-01588-01506-BS	Bushes - Bronze - Sintered - Unflanged
12.700 +0.025/+0.050	15.875 +0.051/+0.076	15.875 +/-0.127			BP01270-01588-01588-BS	Bushes - Bronze - Sintered - Unflanged
12.700 +0.0254/+0.0508	15.875 +0.0508/+0.0762	15.875 +0.127/-0.127			BP01270-01588-01588-BFG	Bushes - Bronze - Sintered - ECO841 Food Grade - Unflanged
12.700 +0.006/+0.024	15.875 +0.028/+0.046	15.875 +/-0.130			BP01270-01588-01588-BSO	Bushes - Bronze - Sintered - Unflanged - Oilite
12.700 +/-0.0254	15.875 +0.0508/+0.0762	15.875 +/-0.127			BP01270-01588-01588-BC9	Bushes - Bronze - Solid - Leaded Gunmetal
12.700 +0.025/+0.050	15.875 +0.051/+0.076	15.875 +/-0.127	22.23	3.18	BF01270-01588-01588-BS	Bushes - Bronze - Sintered - Flanged
12.700 +0.025/+0.050	15.875 +0.051/+0.076	19.050 +/-0.127			BP01270-01588-01905-BS	Bushes - Bronze - Sintered - Unflanged
12.700 +0.0254/+0.0508	15.875 +0.0508/+0.0762	19.050 +0.127/-0.127			BP01270-01588-01905-BFG	Bushes - Bronze - Sintered - ECO841 Food Grade - Unflanged
12.700 +0.006/+0.024	15.875 +0.028/+0.046	19.050 +/-0.160			BP01270-01588-01905-BSO	Bushes - Bronze - Sintered - Unflanged - Oilite
12.700 +/-0.0254	15.875 +0.0508/+0.0762	19.050 +/-0.127			BP01270-01588-01905-BC9	Bushes - Bronze - Solid - Leaded Gunmetal
12.700 +/-0.0254	15.875 +0.0508/+0.0762	19.050 +/-0.127			BP01270-01588-01905-BLG	Bushes - Bronze - Solid - Leaded Gunmetal
12.700 +0.025/+0.050	15.875 +0.051/+0.076	19.050 +/-0.127	22.23	3.18	BF01270-01588-01905-BS	Bushes - Bronze - Sintered - Flanged
12.700 +0.025/+0.050	15.875 +0.051/+0.076	22.225 +/-0.127			BP01270-01588-02223-BS	Bushes - Bronze - Sintered - Unflanged
12.700 +0.006/+0.024	15.875 +0.028/+0.046	22.225 +/-0.160			BP01270-01588-02223-BSO	Bushes - Bronze - Sintered - Unflanged - Oilite
12.700 +0.025/+0.050	15.875 +0.051/+0.076	25.400 +/-0.127			BP01270-01588-02540-BS	Bushes - Bronze - Sintered - Unflanged
12.700 +0.0254/+0.0508	15.875 +0.0508/+0.0762	25.400 +0.127/-0.127			BP01270-01588-02540-BFG	Bushes - Bronze - Sintered - ECO841 Food Grade - Unflanged
12.700 +0.006/+0.024	15.875 +0.028/+0.046	25.400 +/-0.160			BP01270-01588-02540-BSO	Bushes - Bronze - Sintered - Unflanged - Oilite
12.700 +/-0.0254	15.875 +0.0508/+0.0762	25.400 +/-0.127			BP01270-01588-02540-BC9	Bushes - Bronze - Solid - Leaded Gunmetal
12.700 +/-0.0254	15.875 +0.0508/+0.0762	25.400 +/-0.127			BP01270-01588-02540-BLG	Bushes - Bronze - Solid - Leaded Gunmetal
12.700 +0.006/+0.024	15.875 +0.028/+0.046	25.400 +/-0.160	19.05	2.49	BF01270-01588-02540-BSO	Bushes - Bronze - Sintered - Flanged - Oilite
12.700 +0.025/+0.050	15.875 +0.051/+0.076	25.400 +/-0.127	22.23	3.18	BF01270-01588-02540-BS	Bushes - Bronze - Sintered - Flanged
12.700 +0.050/+0.076	15.875 +0.051/+0.076	26.162 +/-0.127			BP01270-01588-02616-BS	Bushes - Bronze - Sintered - Unflanged
12.700 +0.025/-0	15.875 +0.025/+0.076	28.575 +/-0.397			BP01270-01588-02858-BS02	Bushes - Bronze - Sintered - Unflanged
12.700 +0.025/+0.050	15.875 +0.051/+0.076	28.575 +/-0.127			BP01270-01588-02858-BS05	Bushes - Bronze - Sintered - Unflanged
12.700 +0.025/+0.050	15.875 +0.051/+0.076	31.750 +/-0.127			BP01270-01588-03175-BS	Bushes - Bronze - Sintered - Unflanged

 Stocked or Short Delivery

 Usually Available

 Long delivery or not in current production

ID	OD	B	DF	bf	Part Number	Type
12.700 x 15.875 mm (0.500 x 0.625 in.)						
12.700 +0.0254/+0.0508	15.875 +0.0508/+0.0762	31.750 +0.127/-0.127			BP01270-01588-03175-BFG	Bushes - Bronze - Sintered - ECO841 Food Grade - Unflanged
12.700 +/-0.0254	15.875 +0.0508/+0.0762	31.750 +/-0.127			BP01270-01588-03175-BC9	Bushes - Bronze - Solid - Leaded Gunmetal
12.700 +/-0.0254	15.875 +0.0508/+0.0762	31.750 +/-0.127			BP01270-01588-03175-BLG	Bushes - Bronze - Solid - Leaded Gunmetal
12.700 +0.025/+0.050	15.875 +0.051/+0.076	31.750 +/-0.127	22.23	3.18	BF01270-01588-03175-BS	Bushes - Bronze - Sintered - Flanged
12.700 +0.025/+0.050	15.875 +0.051/+0.076	38.100 +/-0.127			BP01270-01588-03810-BS	Bushes - Bronze - Sintered - Unflanged
12.700 +/-0.0254	15.875 +0.0508/+0.0762	38.100 +/-0.127			BP01270-01588-03810-BC9	Bushes - Bronze - Solid - Leaded Gunmetal
12.700 +/-0.0254	15.875 +0.0508/+0.0762	38.100 +/-0.127			BP01270-01588-03810-BLG	Bushes - Bronze - Solid - Leaded Gunmetal
12.700 +0.025/+0.050	15.875 +0.051/+0.076	38.100 +/-0.127	22.23	3.18	BF01270-01588-03810-BS	Bushes - Bronze - Sintered - Flanged
12.700 +0.025/+0.050	15.875 +0.051/+0.076	44.450 +/-0.190	22.23	3.18	BF01270-01588-04445-BS	Bushes - Bronze - Sintered - Flanged
12.700 +/-0.0254	15.875 +0.0508/+0.0762	50.800 +/-0.127			BP01270-01588-05080-BC9	Bushes - Bronze - Solid - Leaded Gunmetal
12.700 +/-0.0254	15.875 +0.0508/+0.0762	50.800 +/-0.127			BP01270-01588-05080-BLG	Bushes - Bronze - Solid - Leaded Gunmetal
12.700 x 17.463 mm (0.500 x 0.688 in.)						
12.700 +0.025/+0.050	17.463 +0.039/+0.064	12.700 +/-0.127			BP01270-01746-01270-BS	Bushes - Bronze - Sintered - Unflanged
12.700 +0.025/+0.050	17.463 +0.039/+0.064	12.700 +/-0.127	23.84	3.18	BF01270-01746-01270-BS	Bushes - Bronze - Sintered - Flanged
12.700 +0.025/+0.050	17.463 +0.039/+0.064	15.875 +/-0.127			BP01270-01746-01588-BS	Bushes - Bronze - Sintered - Unflanged
12.700 +0.025/+0.050	17.463 +0.039/+0.064	19.050 +/-0.127			BP01270-01746-01905-BS	Bushes - Bronze - Sintered - Unflanged
12.700 +0.025/+0.050	17.463 +0.039/+0.064	19.050 +/-0.127	23.84	3.18	BF01270-01746-01905-BS	Bushes - Bronze - Sintered - Flanged
12.700 +0.025/+0.050	17.463 +0.039/+0.064	22.225 +/-0.127			BP01270-01746-02223-BS	Bushes - Bronze - Sintered - Unflanged
12.700 +0.025/+0.050	17.463 +0.039/+0.064	25.400 +/-0.127			BP01270-01746-02540-BS	Bushes - Bronze - Sintered - Unflanged
12.700 +/-0.0254	17.463 +0.0508/+0.0762	25.400 +/-0.127			BP01270-01746-02540-BLG	Bushes - Bronze - Solid - Leaded Gunmetal
12.700 +0.025/-0	17.463 +0.026/+0.077	28.575 +/-0.397			BP01270-01746-02858-BS02	Bushes - Bronze - Sintered - Unflanged
12.700 +0.025/+0.050	17.463 +0.039/+0.064	28.575 +/-0.127			BP01270-01746-02858-BS05	Bushes - Bronze - Sintered - Unflanged
12.700 +0.025/+0.050	17.463 +0.039/+0.064	31.750 +/-0.127			BP01270-01746-03175-BS	Bushes - Bronze - Sintered - Unflanged
12.700 +0.025/+0.050	17.463 +0.039/+0.064	38.100 +/-0.127			BP01270-01746-03810-BS	Bushes - Bronze - Sintered - Unflanged
12.700 +/-0.0254	17.463 +0.0508/+0.0762	38.100 +/-0.127			BP01270-01746-03810-BLG	Bushes - Bronze - Solid - Leaded Gunmetal
12.700 +/-0.0254	17.463 +0.0508/+0.0762	50.800 +/-0.127			BP01270-01746-05080-BLG	Bushes - Bronze - Solid - Leaded Gunmetal
12.700 x 19.050 mm (0.500 x 0.750 in.)						
12.700 +0.050/+0.076	19.050 +0.064/+0.089	6.350 +/-0.127			BP01270-01905-00635-BS	Bushes - Bronze - Sintered - Unflanged
12.700 +0.025/+0.050	19.050 +0.051/+0.076	9.525 +/-0.127			BP01270-01905-00953-BS	Bushes - Bronze - Sintered - Unflanged
12.700 +0.0254/+0.0508	19.050 +0.0508/+0.0762	9.525 +0.127/-0.127			BP01270-01905-00953-BFG	Bushes - Bronze - Sintered - ECO841 Food Grade - Unflanged
12.700 +0.050/+0.076	19.050 +0.064/+0.089	11.100 +0/-0.203			BP01270-01905-01110-BS	Bushes - Bronze - Sintered - Unflanged
12.700 +0.025/+0.050	19.050 +0.051/+0.076	12.700 +/-0.127			BP01270-01905-01270-BS	Bushes - Bronze - Sintered - Unflanged
12.700 +0.038/+0.063	19.050 +0.025/+0.050	12.700 +0.00/-0.51			BP01270-01905-01270-AF	Bushes - Aluminium - Frelon Lined - Unflanged
12.700 +0.0254/+0.0508	19.050 +0.0508/+0.0762	12.700 +0.127/-0.127			BP01270-01905-01270-BFG	Bushes - Bronze - Sintered - ECO841 Food Grade - Unflanged
12.700 +0.025/+0.050	19.050 +0.051/+0.076	12.700 +/-0.127	25.40	3.18	BF01270-01905-01270-BS	Bushes - Bronze - Sintered - Flanged
12.700 +0.038/+0.063	19.050 +0.025/+0.050	12.700 +0.00/-0.51	25.40	3.18	BF01270-01905-01270-AF	Bushes - Aluminium - Frelon Lined - Flanged
12.700 +0.006/+0.024	19.050 +0.035/+0.056	12.700 +/-0.130	25.40	3.18	BF01270-01905-01270-BSO	Bushes - Bronze - Sintered - Flanged - Oilite
12.700 +0.025/+0.051	19.050 +0.077/+0.102	13.081 +/-0.127	22.23	3.68	BF01270-01905-01308-BS	Bushes - Bronze - Sintered - Flanged
12.700 +0.025/+0.050	19.050 +0.051/+0.076	15.875 +/-0.127			BP01270-01905-01588-BS	Bushes - Bronze - Sintered - Unflanged

 Stocked or Short Delivery

 Usually Available

 Long delivery or not in current production

ID	OD	B	DF	bf	Part Number	Type
12.700 x 19.050 mm (0.500 x 0.750 in.)						
12.700 +0.0254/+0.0508	19.050 +0.0508/+0.0762	15.875 +0.127/-0.127			BP01270-01905-01588-BFG	Bushes - Bronze - Sintered - ECO841 Food Grade - Unflanged
12.700 +0.025/+0.050	19.050 +0.051/+0.076	15.875 +/-0.127	25.40	3.18	BF01270-01905-01588-BS	Bushes - Bronze - Sintered - Flanged
12.700 +/-0.0254	19.050 +0.0508/+0.0762	19.050 +/-0.127			BP01270-01905-01905-BLG	Bushes - Bronze - Solid - Leaded Gunmetal
12.700 +0.038/+0.063	19.050 +0.025/+0.050	19.050 +0.00/-0.51			BP01270-01905-01905-AF	Bushes - Aluminium - Frelon Lined - Unflanged
12.700 +0.025/+0.050	19.050 +0.051/+0.076	19.050 +/-0.127			BP01270-01905-01905-BS05	Bushes - Bronze - Sintered - Unflanged
12.700 +0.050/+0.076	19.050 +0.064/+0.089	19.050 +/-0.127			BP01270-01905-01905-BS08	Bushes - Bronze - Sintered - Unflanged
12.700 +0.0254/+0.0508	19.050 +0.0508/+0.0762	19.050 +0.127/-0.127			BP01270-01905-01905-BFG	Bushes - Bronze - Sintered - ECO841 Food Grade - Unflanged
12.700 +/-0.0254	19.050 +0.0508/+0.0762	19.050 +/-0.127			BP01270-01905-01905-BC9	Bushes - Bronze - Solid - Leaded Gunmetal
12.700 +0.050/+0.076	19.050 +0.051/+0.076	19.050 +/-0.127	23.81	3.18	BF01270-01905-01905-BS08	Bushes - Bronze - Sintered - Flanged
12.700 +0.038/+0.063	19.050 +0.025/+0.050	19.050 +0.00/-0.51	25.40	3.18	BF01270-01905-01905-AF	Bushes - Aluminium - Frelon Lined - Flanged
12.700 +0.025/+0.050	19.050 +0.051/+0.076	19.050 +/-0.127	25.40	3.18	BF01270-01905-01905-BS05	Bushes - Bronze - Sintered - Flanged
12.700 +0.006/+0.024	19.050 +0.035/+0.056	19.050 +/-0.160	25.40	3.18	BF01270-01905-01905-BSO	Bushes - Bronze - Sintered - Flanged - Oilite
12.700 +0.025/+0.050	19.050 +0.051/+0.076	22.225 +/-0.127			BP01270-01905-02223-BS	Bushes - Bronze - Sintered - Unflanged
12.700 +0.025/+0.050	19.050 +0.051/+0.076	22.225 +/-0.127	25.40	3.18	BF01270-01905-02223-BS	Bushes - Bronze - Sintered - Flanged
12.700 +0.025/+0.051	19.050 +0.077/+0.102	24.613 +/-0.127	22.23	1.52	BF01270-01905-02461-BS	Bushes - Bronze - Sintered - Flanged
12.700 +0.025/+0.050	19.050 +0.051/+0.076	25.400 +/-0.127			BP01270-01905-02540-BS	Bushes - Bronze - Sintered - Unflanged
12.700 +0.038/+0.063	19.050 +0.025/+0.050	25.400 +0.00/-0.51			BP01270-01905-02540-AF	Bushes - Aluminium - Frelon Lined - Unflanged
12.700 +0.0254/+0.0508	19.050 +0.0508/+0.0762	25.400 +0.127/-0.127			BP01270-01905-02540-BFG	Bushes - Bronze - Sintered - ECO841 Food Grade - Unflanged
12.700 +/-0.0254	19.050 +0.0508/+0.0762	25.400 +/-0.127			BP01270-01905-02540-BC9	Bushes - Bronze - Solid - Leaded Gunmetal
12.700 +/-0.0254	19.050 +0.0508/+0.0762	25.400 +/-0.127			BP01270-01905-02540-BLG	Bushes - Bronze - Solid - Leaded Gunmetal
12.700 +0.038/+0.063	19.050 +0.025/+0.050	25.400 +0.00/-0.51	25.40	3.18	BF01270-01905-02540-AF	Bushes - Aluminium - Frelon Lined - Flanged
12.700 +0.025/+0.050	19.050 +0.051/+0.076	25.400 +/-0.127	25.40	3.18	BF01270-01905-02540-BS	Bushes - Bronze - Sintered - Flanged
12.700 +0.006/+0.024	19.050 +0.035/+0.056	25.400 +/-0.160	25.40	3.18	BF01270-01905-02540-BSO	Bushes - Bronze - Sintered - Flanged - Oilite
12.700 +0.025/-0	19.050 +0.025/+0.076	28.575 +/-0.397			BP01270-01905-02858-BS02	Bushes - Bronze - Sintered - Unflanged
12.700 +0.025/+0.050	19.050 +0.051/+0.076	28.575 +/-0.127			BP01270-01905-02858-BS05	Bushes - Bronze - Sintered - Unflanged
12.700 +0.0254/+0.0508	19.050 +0.0508/+0.0762	31.750 +0.127/-0.127			BP01270-01905-03175-BS	Bushes - Bronze - Sintered - Unflanged
12.700 +0.0254/+0.0508	19.050 +0.0508/+0.0762	31.750 +0.127/-0.127			BP01270-01905-03175-BFG	Bushes - Bronze - Sintered - ECO841 Food Grade - Unflanged
12.700 +/-0.0254	19.050 +0.0508/+0.0762	31.750 +/-0.127			BP01270-01905-03175-BC9	Bushes - Bronze - Solid - Leaded Gunmetal
12.700 +0.025/+0.050	19.050 +0.051/+0.076	31.750 +/-0.127	25.40	3.18	BF01270-01905-03175-BS	Bushes - Bronze - Sintered - Flanged
12.700 +0.025/+0.050	19.050 +0.051/+0.076	38.100 +/-0.127			BP01270-01905-03810-BS	Bushes - Bronze - Sintered - Unflanged
12.700 +/-0.0254	19.050 +0.0508/+0.0762	38.100 +/-0.127			BP01270-01905-03810-BC9	Bushes - Bronze - Solid - Leaded Gunmetal
12.700 +/-0.0254	19.050 +0.0508/+0.0762	38.100 +/-0.127			BP01270-01905-03810-BLG	Bushes - Bronze - Solid - Leaded Gunmetal
12.700 +0.025/+0.050	19.050 +0.051/+0.076	38.100 +/-0.127	25.40	3.18	BF01270-01905-03810-BS	Bushes - Bronze - Sintered - Flanged
12.700 +0.025/+0.050	19.050 +0.051/+0.076	44.450 +/-0.190			BP01270-01905-04445-BS	Bushes - Bronze - Sintered - Unflanged
12.700 +/-0.0254	19.050 +0.0508/+0.0762	44.450 +/-0.127			BP01270-01905-04445-BLG	Bushes - Bronze - Solid - Leaded Gunmetal
12.700 +0.025/+0.050	19.050 +0.051/+0.076	50.800 +/-0.190			BP01270-01905-05080-BS	Bushes - Bronze - Sintered - Unflanged
12.700 +/-0.0254	19.050 +0.0508/+0.0762	50.800 +/-0.127			BP01270-01905-05080-BC9	Bushes - Bronze - Solid - Leaded Gunmetal
12.700 +/-0.0254	19.050 +0.0508/+0.0762	50.800 +/-0.127			BP01270-01905-05080-BLG	Bushes - Bronze - Solid - Leaded Gunmetal
12.700 +/-0.0254	19.050 +0.0508/+0.0762	63.500 +/-0.127			BP01270-01905-06350-BLG	Bushes - Bronze - Solid - Leaded Gunmetal

Stocked or Short Delivery

Usually Available

Long delivery or not in current production

ID	OD	B	DF	bf	Part Number	Type
12.700 x 20.638 mm (0.500 x 0.813 in.)						
12.700 +0.025/+0.050	20.638 +0.039/+0.064	12.700 +/-0.127			BP01270-02064-01270-BS	Bushes - Bronze - Sintered - Unflanged
12.700 +0.025/+0.050	20.638 +0.039/+0.064	19.050 +/-0.127			BP01270-02064-01905-BS	Bushes - Bronze - Sintered - Unflanged
12.700 +0.025/+0.050	20.638 +0.039/+0.064	25.400 +/-0.127			BP01270-02064-02540-BS	Bushes - Bronze - Sintered - Unflanged
12.700 +0.025/+0.050	20.638 +0.039/+0.064	38.100 +/-0.127			BP01270-02064-03810-BS	Bushes - Bronze - Sintered - Unflanged
12.700 x 22.225 mm (0.500 x 0.875 in.)						
12.700 +0.025/+0.050	22.225 +0.051/+0.076	12.700 +/-0.127			BP01270-02223-01270-BS	Bushes - Bronze - Sintered - Unflanged
12.700 +0.025/+0.050	22.225 +0.051/+0.076	15.875 +/-0.127			BP01270-02223-01588-BS	Bushes - Bronze - Sintered - Unflanged
12.700 +0.025/+0.050	22.225 +0.051/+0.076	19.050 +/-0.127			BP01270-02223-01905-BS	Bushes - Bronze - Sintered - Unflanged
12.700 +0.025/+0.050	22.225 +0.051/+0.076	22.225 +/-0.127			BP01270-02223-02223-BS	Bushes - Bronze - Sintered - Unflanged
12.700 +0.025/+0.050	22.225 +0.051/+0.076	25.400 +/-0.127			BP01270-02223-02540-BS	Bushes - Bronze - Sintered - Unflanged
12.700 +0.025/+0.050	22.225 +0.051/+0.076	31.750 +/-0.127			BP01270-02223-03175-BS	Bushes - Bronze - Sintered - Unflanged
12.700 +0.025/+0.050	22.225 +0.051/+0.076	38.100 +/-0.127			BP01270-02223-03810-BS	Bushes - Bronze - Sintered - Unflanged
12.700 +/-0.0254	22.225 +0.0508/+0.0762	38.100 +/-0.127			BP01270-02223-03810-BLG	Bushes - Bronze - Solid - Leaded Gunmetal
12.700 +/-0.0254	22.225 +0.0508/+0.0762	50.800 +/-0.127			BP01270-02223-05080-BLG	Bushes - Bronze - Solid - Leaded Gunmetal
12.700 x 25.400 mm (0.500 x 1.000 in.)						
12.700 +0.025/+0.050	25.400 +0.077/+0.102	19.050 +/-0.127			BP01270-02540-01905-BS	Bushes - Bronze - Sintered - Unflanged
12.700 +0.025/+0.050	25.400 +0.077/+0.102	25.400 +/-0.127			BP01270-02540-02540-BS	Bushes - Bronze - Sintered - Unflanged
12.700 +0.025/+0.050	25.400 +0.077/+0.102	38.100 +/-0.127			BP01270-02540-03810-BS	Bushes - Bronze - Sintered - Unflanged
12.700 +0.025/+0.050	25.400 +0.077/+0.102	50.800 +/-0.190			BP01270-02540-05080-BS	Bushes - Bronze - Sintered - Unflanged
12.700 +/-0.0254	25.400 +0.0508/+0.0762	50.800 +/-0.127			BP01270-02540-05080-BLG	Bushes - Bronze - Solid - Leaded Gunmetal
12.700 x 28.575 mm (0.500 x 1.125 in.)						
12.700 +0.010/-0	28.575 +0.003/-0.002	7.938 +0/-0.127			BP01270-02858-00794-BS	Bushes - Bronze - Sintered - Unflanged
12.700 +0.010/-0	28.575 +0.003/-0.010	7.938 +0/-0.127	31.75	1.57	BF01270-02858-00794-BS	Bushes - Bronze - Sintered - Flanged
13.000 x 15.000 mm (0.512 x 0.591 in.)						
13.000 -0.000/-0.018	15.000 +0.018/-0.000	10.000 +0.25/-0.25			BP01300-01500-01000-DP4	Bushes - Steel - DP4 - Split - Unflanged
13.000 -0.000/-0.034	15.000 +0.065/-0.000	10.000 +0.00/-0.30			BP01300-01500-01000-DU	Bushes - Steel - DU - Split - Unflanged
13.000 -0.000/-0.034	15.000 +0.065/-0.000	10.000 +0.00/-0.30			BP01300-01500-01000-SS6	Bushes - Stainless Steel and PTFE - Unflanged
13.000 -0.000/-0.034	15.000 +0.065/-0.000	20.000 +0.00/-0.30			BP01300-01500-02000-SS6	Bushes - Stainless Steel and PTFE - Unflanged
13.000 -0.000/-0.034	15.000 +0.065/-0.000	20.000 +0.00/-0.30			BP01300-01500-02000-DU	Bushes - Steel - DU - Split - Unflanged
13.000 -0.000/-0.018	15.000 +0.018/-0.000	20.000 +0.25/-0.25			BP01300-01500-02000-DP4	Bushes - Steel - DP4 - Split - Unflanged
14.000 x 16.000 mm (0.551 x 0.630 in.)						
14.000 -0.000/-0.018	16.000 +0.018/-0.000	5.000 +0.25/-0.25			BP01400-01600-00500-DP4	Bushes - Steel - DP4 - Split - Unflanged
14.000 -0.000/-0.034	16.000 +0.065/-0.000	5.000 +0.25/-0.25			BP01400-01600-00500-DU	Bushes - Steel - DU - Split - Unflanged
14.000 -0.000/-0.018	16.000 +0.018/-0.000	10.000 +0.25/-0.25			BP01400-01600-01000-DP4	Bushes - Steel - DP4 - Split - Unflanged
14.000 -0.000/-0.034	16.000 +0.065/-0.000	10.000 +0.00/-0.30			BP01400-01600-01000-DU	Bushes - Steel - DU - Split - Unflanged
14.000 -0.000/-0.034	16.000 +0.065/-0.000	10.000 +0.25/-0.25			BP01400-01600-01000-DUB	Bushes - Steel - DUB - Split - Unflanged
14.000 -0.000/-0.034	16.000 +0.065/-0.000	10.000 +0.00/-0.30			BP01400-01600-01000-SS6	Bushes - Stainless Steel and PTFE - Unflanged
14.000 -0.000/-0.018	16.000 +0.018/-0.000	12.000 +0.25/-0.25			BP01400-01600-01200-DP4	Bushes - Steel - DP4 - Split - Unflanged
14.000 -0.000/-0.034	16.000 +0.065/-0.000	12.000 +0.00/-0.30			BP01400-01600-01200-SS6	Bushes - Stainless Steel and PTFE - Unflanged

 Stocked or Short Delivery

 Usually Available

 Long delivery or not in current production

ID	OD	B	DF	bf	Part Number	Type
14.000 x 16.000 mm (0.551 x 0.630 in.)						
14.000 -0.000/-0.034	16.000 +0.065/-0.000	12.000 +0.00/-0.30			BP01400-01600-01200-DU	Bushes - Steel - DU - Split - Unflanged
14.000 -0.000/-0.034	16.000 +0.065/-0.000	12.000 +0.25/-0.25	22.00	1.00	BF01400-01600-01200-DU	Bushes - Steel - DU - Split - Flanged
14.000 -0.000/-0.034	16.000 +0.065/-0.000	12.000 +0.25/-0.25	22.00	1.00	BF01400-01600-01200-SS6	Bushes - Stainless Steel and PTFE - Flanged
14.000 -0.000/-0.018	16.000 +0.018/-0.000	12.000 +0.25/-0.25	22.00	1.00	BF01400-01600-01200-DP4	Bushes - Steel - DP4 - Split - Flanged
14.000 -0.000/-0.018	16.000 +0.018/-0.000	15.000 +0.25/-0.25			BP01400-01600-01500-DP4	Bushes - Steel - DP4 - Split - Unflanged
14.000 -0.000/-0.034	16.000 +0.065/-0.000	15.000 +0.00/-0.30			BP01400-01600-01500-DU	Bushes - Steel - DU - Split - Unflanged
14.000 -0.000/-0.034	16.000 +0.065/-0.000	15.000 +0.25/-0.25			BP01400-01600-01500-DUB	Bushes - Steel - DUB - Split - Unflanged
14.000 -0.000/-0.034	16.000 +0.065/-0.000	15.000 +0.00/-0.30			BP01400-01600-01500-SS6	Bushes - Stainless Steel and PTFE - Unflanged
14.000 -0.000/-0.034	16.000 +0.065/-0.000	15.000 +0.25/-0.25			BP01400-01600-01500-DX	Bushes - Steel - DX - Split - Unflanged
14.000 -0.000/-0.034	16.000 +0.065/-0.000	17.000 +0.25/-0.25	22.00	0.95	BF01400-01600-01700-DUB	Bushes - Steel - DUB - Split - Flanged
14.000 -0.000/-0.018	16.000 +0.018/-0.000	17.000 +0.25/-0.25	22.00	1.00	BF01400-01600-01700-DP4	Bushes - Steel - DP4 - Split - Flanged
14.000 -0.000/-0.034	16.000 +0.065/-0.000	17.000 +0.25/-0.25	22.00	1.00	BF01400-01600-01700-DU	Bushes - Steel - DU - Split - Flanged
14.000 -0.000/-0.034	16.000 +0.065/-0.000	17.000 +0.25/-0.25	22.00	1.00	BF01400-01600-01700-SS6	Bushes - Stainless Steel and PTFE - Flanged
14.000 -0.000/-0.034	16.000 +0.065/-0.000	20.000 +0.25/-0.25			BP01400-01600-02000-DUB	Bushes - Steel - DUB - Split - Unflanged
14.000 -0.000/-0.034	16.000 +0.065/-0.000	20.000 +0.00/-0.30			BP01400-01600-02000-SS6	Bushes - Stainless Steel and PTFE - Unflanged
14.000 -0.000/-0.034	16.000 +0.065/-0.000	20.000 +0.00/-0.30			BP01400-01600-02000-DU	Bushes - Steel - DU - Split - Unflanged
14.000 -0.000/-0.018	16.000 +0.018/-0.000	20.000 +0.25/-0.25			BP01400-01600-02000-DP4	Bushes - Steel - DP4 - Split - Unflanged
14.000 -0.000/-0.034	16.000 +0.065/-0.000	20.000 +0.25/-0.25			BP01400-01600-02000-DX	Bushes - Steel - DX - Split - Unflanged
14.000 -0.000/-0.018	16.000 +0.065/-0.000	25.000 +0.25/-0.25			BP01400-01600-02500-DP4	Bushes - Steel - DP4 - Split - Unflanged
14.000 -0.000/-0.034	16.000 +0.065/-0.000	25.000 +0.00/-0.30			BP01400-01600-02500-DU	Bushes - Steel - DU - Split - Unflanged
14.000 -0.000/-0.034	16.000 +0.065/-0.000	25.000 +0.00/-0.30			BP01400-01600-02500-SS6	Bushes - Stainless Steel and PTFE - Unflanged
14.000 -0.000/-0.034	16.000 +0.065/-0.000	25.000 +0.25/-0.25			BP01400-01600-02500-DX	Bushes - Steel - DX - Split - Unflanged
14.000 x 18.000 mm (0.551 x 0.709 in.)						
14.000 +0.006/+0.024	18.000 +0.028/+0.046	10.000 +/-0.110			BP01400-01800-01000-BSO	Bushes - Bronze - Sintered - Unflanged - Oilite
14.000 +0.006/+0.024	18.000 +0.028/+0.046	14.000 +/-0.130			BP01400-01800-01400-BSO	Bushes - Bronze - Sintered - Unflanged - Oilite
14.000 +0.006/+0.024	18.000 +0.028/+0.046	20.000 +/-0.160			BP01400-01800-02000-BSO	Bushes - Bronze - Sintered - Unflanged - Oilite
14.000 x 20.000 mm (0.551 x 0.787 in.)						
14.000 +0.006/+0.024	20.000 +0.035/+0.056	10.000 +/-0.110			BP01400-02000-01000-BSO	Bushes - Bronze - Sintered - Unflanged - Oilite
14.000 +0.006/+0.024	20.000 +0.035/+0.056	10.000 +/-0.110	26.00	3.00	BF01400-02000-01000-BSO	Bushes - Bronze - Sintered - Flanged - Oilite
14.000 +0.006/+0.024	20.000 +0.035/+0.056	14.000 +/-0.130			BP01400-02000-01400-BSO	Bushes - Bronze - Sintered - Unflanged - Oilite
14.000 +0.006/+0.024	20.000 +0.035/+0.056	14.000 +/-0.130	26.00	3.00	BF01400-02000-01400-BSO	Bushes - Bronze - Sintered - Flanged - Oilite
14.000 +0.006/+0.024	20.000 +0.035/+0.056	20.000 +/-0.160			BP01400-02000-02000-BSO	Bushes - Bronze - Sintered - Unflanged - Oilite
14.000 +0.006/+0.024	20.000 +0.035/+0.056	20.000 +/-0.160	26.00	3.00	BF01400-02000-02000-BSO	Bushes - Bronze - Sintered - Flanged - Oilite
14.000 +0.006/+0.024	20.000 +0.035/+0.056	30.000 +/-0.160			BP01400-02000-03000-BSO	Bushes - Bronze - Sintered - Unflanged - Oilite
14.288 x 16.669 mm (0.563 x 0.656 in.)						
14.288 -0.025/-0.051	16.669 +0.009/-0.009	9.525 +0.25/-0.25			BP01429-01667-00953-SS6	Bushes - Stainless Steel and PTFE - Unflanged
14.288 -0.025/-0.051	16.669 +0.009/-0.009	9.525 +0.00/-0.30			BP01429-01667-00953-DP4	Bushes - Steel - DP4 - Split - Unflanged
14.288 -0.025/-0.051	16.669 +0.009/-0.009	9.525 +0.00/-0.30			BP01429-01667-00953-DU	Bushes - Steel - DU - Split - Unflanged
14.288 -0.025/-0.051	16.669 +0.009/-0.009	12.700 +0.00/-0.30			BP01429-01667-01270-DU	Bushes - Steel - DU - Split - Unflanged
14.288 -0.025/-0.051	16.669 +0.009/-0.009	12.700 +0.25/-0.25			BP01429-01667-01270-SS6	Bushes - Stainless Steel and PTFE - Unflanged

 Stocked or Short Delivery

 Usually Available

 Long delivery or not in current production

ID	OD	B	DF	bf	Part Number	Type
14.288 x 16.669 mm (0.563 x 0.656 in.)						
14.288 -0.025/-0.051	16.669 +0.009/-0.009	12.700 +0.00/-0.30			BP01429-01667-01270-DP4	Bushes - Steel - DP4 - Split - Unflanged
14.288 -0.025/-0.051	16.669 +0.009/-0.009	15.875 +0.00/-0.30			BP01429-01667-01588-DP4	Bushes - Steel - DP4 - Split - Unflanged
14.288 -0.025/-0.051	16.669 +0.009/-0.009	15.875 +0.00/-0.30			BP01429-01667-01588-DU	Bushes - Steel - DU - Split - Unflanged
14.288 -0.025/-0.051	16.669 +0.009/-0.009	15.875 +0.25/-0.25			BP01429-01667-01588-SS6	Bushes - Stainless Steel and PTFE - Unflanged
14.288 -0.025/-0.051	16.669 +0.009/-0.009	19.050 +0.00/-0.30			BP01429-01667-01905-DP4	Bushes - Steel - DP4 - Split - Unflanged
14.288 -0.025/-0.051	16.669 +0.009/-0.009	19.050 +0.00/-0.30			BP01429-01667-01905-DU	Bushes - Steel - DU - Split - Unflanged
14.288 -0.025/-0.051	16.669 +0.009/-0.009	19.050 +0.25/-0.25			BP01429-01667-01905-SS6	Bushes - Stainless Steel and PTFE - Unflanged
14.288 x 17.463 mm (0.563 x 0.688 in.)						
14.288 +0.025/+0.050	17.463 +0.039/+0.064	12.700 +/-0.127			BP01429-01746-01270-BS	Bushes - Bronze - Sintered - Unflanged
14.288 +0.007/+0.025	17.463 +0.040/+0.058	12.700 +/-0.130			BP01429-01746-01270-BSO	Bushes - Bronze - Sintered - Unflanged - Oilite
14.288 +0.025/+0.050	17.463 +0.039/+0.064	19.050 +/-0.127			BP01429-01746-01905-BS	Bushes - Bronze - Sintered - Unflanged
14.288 +0.007/+0.025	17.463 +0.040/+0.058	19.050 +/-0.160			BP01429-01746-01905-BSO	Bushes - Bronze - Sintered - Unflanged - Oilite
14.288 +0.025/+0.050	17.463 +0.039/+0.064	25.400 +/-0.127			BP01429-01746-02540-BS	Bushes - Bronze - Sintered - Unflanged
14.288 +/-0.0254	17.463 +0.0508/+0.0762	25.400 +/-0.127			BP01429-01746-02540-BLG	Bushes - Bronze - Solid - Leaded Gunmetal
14.288 +0.025/+0.050	17.463 +0.039/+0.064	31.750 +/-0.127			BP01429-01746-03175-BS	Bushes - Bronze - Sintered - Unflanged
14.288 +0.025/+0.050	17.463 +0.039/+0.064	38.100 +/-0.127			BP01429-01746-03810-BS	Bushes - Bronze - Sintered - Unflanged
14.288 +/-0.0254	17.463 +0.0508/+0.0762	38.100 +/-0.127			BP01429-01746-03810-BLG	Bushes - Bronze - Solid - Leaded Gunmetal
14.288 +/-0.0254	17.463 +0.0508/+0.0762	44.450 +/-0.127			BP01429-01746-04445-BLG	Bushes - Bronze - Solid - Leaded Gunmetal
14.288 +/-0.0254	17.463 +0.0508/+0.0762	50.800 +/-0.127			BP01429-01746-05080-BLG	Bushes - Bronze - Solid - Leaded Gunmetal
14.288 x 19.050 mm (0.563 x 0.750 in.)						
14.288 +0.025/+0.050	19.050 +0.051/+0.076	12.700 +/-0.127			BP01429-01905-01270-BS	Bushes - Bronze - Sintered - Unflanged
14.288 +0.025/+0.050	19.050 +0.051/+0.076	19.050 +/-0.127			BP01429-01905-01905-BS	Bushes - Bronze - Sintered - Unflanged
14.288 +0.0254/+0.0508	19.050 +0.0508/+0.0762	19.050 +0.127/-0.127			BP01429-01905-01905-BFG	Bushes - Bronze - Sintered - ECO841 Food Grade - Unflanged
14.288 +0.025/+0.050	19.050 +0.051/+0.076	25.400 +/-0.127			BP01429-01905-02540-BS	Bushes - Bronze - Sintered - Unflanged
14.288 +/-0.0254	19.050 +0.0508/+0.0762	25.400 +/-0.127			BP01429-01905-02540-BLG	Bushes - Bronze - Solid - Leaded Gunmetal
14.288 +0.025/+0.050	19.050 +0.051/+0.076	25.400 +/-0.127	25.40	3.18	BF01429-01905-02540-BS	Bushes - Bronze - Sintered - Flanged
14.288 +0.025/+0.050	19.050 +0.051/+0.076	31.750 +/-0.127			BP01429-01905-03175-BS	Bushes - Bronze - Sintered - Unflanged
14.288 +0.0254/+0.0508	19.050 +0.0508/+0.0762	31.750 +0.127/-0.127			BP01429-01905-03175-BFG	Bushes - Bronze - Sintered - ECO841 Food Grade - Unflanged
14.288 +/-0.0254	19.050 +0.0508/+0.0762	31.750 +/-0.127			BP01429-01905-03175-BC9	Bushes - Bronze - Solid - Leaded Gunmetal
14.288 +0.025/+0.050	19.050 +0.051/+0.076	38.100 +/-0.127			BP01429-01905-03810-BS	Bushes - Bronze - Sintered - Unflanged
14.288 +/-0.0254	19.050 +0.0508/+0.0762	38.100 +/-0.127			BP01429-01905-03810-BLG	Bushes - Bronze - Solid - Leaded Gunmetal
14.288 +/-0.0254	19.050 +0.0508/+0.0762	44.450 +/-0.127			BP01429-01905-04445-BLG	Bushes - Bronze - Solid - Leaded Gunmetal
14.288 +/-0.0254	19.050 +0.0508/+0.0762	50.800 +/-0.127			BP01429-01905-05080-BLG	Bushes - Bronze - Solid - Leaded Gunmetal
14.288 +/-0.0254	19.050 +0.0508/+0.0762	57.150 +/-0.127			BP01429-01905-05715-BLG	Bushes - Bronze - Solid - Leaded Gunmetal
14.288 +/-0.0254	19.050 +0.0508/+0.0762	63.500 +/-0.127			BP01429-01905-06350-BLG	Bushes - Bronze - Solid - Leaded Gunmetal
14.288 x 20.638 mm (0.563 x 0.813 in.)						
14.288 +0.025/+0.050	20.638 +0.039/+0.064	12.700 +/-0.127			BP01429-02064-01270-BS	Bushes - Bronze - Sintered - Unflanged
14.288 +0.025/+0.050	20.638 +0.039/+0.064	19.050 +/-0.127			BP01429-02064-01905-BS	Bushes - Bronze - Sintered - Unflanged
14.288 +0.025/+0.050	20.638 +0.039/+0.064	25.400 +/-0.127			BP01429-02064-02540-BS	Bushes - Bronze - Sintered - Unflanged

 Stocked or Short Delivery

 Usually Available

 Long delivery or not in current production

ID	OD	B	DF	bf	Part Number	Type
14.288 x 20.638 mm (0.563 x 0.813 in.)						
14.288 +/-0.0254	20.638 +0.0508/+0.0762	25.400 +/-0.127			BP01429-02064-02540-BLG	Bushes - Bronze - Solid - Leaded Gunmetal
14.288 +0.025/+0.050	20.638 +0.039/+0.064	31.750 +/-0.127			BP01429-02064-03175-BS	Bushes - Bronze - Sintered - Unflanged
14.288 +0.025/+0.050	20.638 +0.039/+0.064	38.100 +/-0.127			BP01429-02064-03810-BS	Bushes - Bronze - Sintered - Unflanged
14.288 +/-0.0254	20.638 +0.0508/+0.0762	38.100 +/-0.127			BP01429-02064-03810-BLG	Bushes - Bronze - Solid - Leaded Gunmetal
14.288 +/-0.0254	20.638 +0.0508/+0.0762	50.800 +/-0.127			BP01429-02064-05080-BLG	Bushes - Bronze - Solid - Leaded Gunmetal
14.288 x 22.225 mm (0.563 x 0.875 in.)						
14.288 +/-0.0254	22.225 +0.0508/+0.0762	25.400 +/-0.127			BP01429-02223-02540-BLG	Bushes - Bronze - Solid - Leaded Gunmetal
14.288 +/-0.0254	22.225 +0.0508/+0.0762	38.100 +/-0.127			BP01429-02223-03810-BLG	Bushes - Bronze - Solid - Leaded Gunmetal
14.288 +/-0.0254	22.225 +0.0508/+0.0762	44.450 +/-0.127			BP01429-02223-04445-BLG	Bushes - Bronze - Solid - Leaded Gunmetal
14.288 x 25.400 mm (0.563 x 1.000 in.)						
14.288 +/-0.0254	25.400 +0.0508/+0.0762	38.100 +/-0.127			BP01429-02540-03810-BLG	Bushes - Bronze - Solid - Leaded Gunmetal
14.288 +/-0.0254	25.400 +0.0508/+0.0762	50.800 +/-0.127			BP01429-02540-05080-BLG	Bushes - Bronze - Solid - Leaded Gunmetal
15.000 x 17.000 mm (0.591 x 0.669 in.)						
15.000 -0.000/-0.034	17.000 +0.065/-0.000	9.000 +0.25/-0.25	23.00	1.00	BF01500-01700-00900-DU	Bushes - Steel - DU - Split - Flanged
15.000 -0.000/-0.034	17.000 +0.065/-0.000	9.000 +0.25/-0.25	23.00	1.00	BF01500-01700-00900-SS6	Bushes - Stainless Steel and PTFE - Flanged
15.000 -0.000/-0.018	17.000 +0.018/-0.000	9.000 +0.25/-0.25	23.00	1.00	BF01500-01700-00900-DP4	Bushes - Steel - DP4 - Split - Flanged
15.000 -0.000/-0.034	17.000 +0.065/-0.000	10.000 +0.00/-0.30			BP01500-01700-01000-DU	Bushes - Steel - DU - Split - Unflanged
15.000 -0.000/-0.018	17.000 +0.018/-0.000	10.000 +0.25/-0.25			BP01500-01700-01000-DP4	Bushes - Steel - DP4 - Split - Unflanged
15.000 -0.000/-0.034	17.000 +0.065/-0.000	10.000 +0.00/-0.30			BP01500-01700-01000-SS6	Bushes - Stainless Steel and PTFE - Unflanged
15.000 -0.000/-0.034	17.000 +0.065/-0.000	10.000 +0.25/-0.25			BP01500-01700-01000-DX	Bushes - Steel - DX - Split - Unflanged
15.000 -0.000/-0.018	17.000 +0.018/-0.000	12.000 +0.25/-0.25			BP01500-01700-01200-DP4	Bushes - Steel - DP4 - Split - Unflanged
15.000 -0.000/-0.034	17.000 +0.065/-0.000	12.000 +0.00/-0.30			BP01500-01700-01200-DU	Bushes - Steel - DU - Split - Unflanged
15.000 -0.000/-0.034	17.000 +0.065/-0.000	12.000 +0.00/-0.30			BP01500-01700-01200-SS6	Bushes - Stainless Steel and PTFE - Unflanged
15.000 -0.000/-0.034	17.000 +0.065/-0.000	12.000 +0.25/-0.25			BP01500-01700-01200-DX	Bushes - Steel - DX - Split - Unflanged
15.000 -0.000/-0.034	17.000 +0.065/-0.000	12.000 +0.25/-0.25	23.00	0.80	BF01500-01700-01200-DUB	Bushes - Steel - DUB - Split - Flanged
15.000 -0.000/-0.034	17.000 +0.065/-0.000	12.000 +0.25/-0.25	23.00	1.00	BF01500-01700-01200-SS6	Bushes - Stainless Steel and PTFE - Flanged
15.000 -0.000/-0.034	17.000 +0.065/-0.000	12.000 +0.25/-0.25	23.00	1.00	BF01500-01700-01200-DU	Bushes - Steel - DU - Split - Flanged
15.000 -0.000/-0.018	17.000 +0.018/-0.000	12.000 +0.25/-0.25	23.00	1.00	BF01500-01700-01200-DP4	Bushes - Steel - DP4 - Split - Flanged
15.000 -0.000/-0.034	17.000 +0.065/-0.000	15.000 +0.00/-0.30			BP01500-01700-01500-DU	Bushes - Steel - DU - Split - Unflanged
15.000 -0.000/-0.034	17.000 +0.065/-0.000	15.000 +0.00/-0.30			BP01500-01700-01500-SS6	Bushes - Stainless Steel and PTFE - Unflanged
15.000 -0.000/-0.034	17.000 +0.065/-0.000	15.000 +0.25/-0.25			BP01500-01700-01500-DUB	Bushes - Steel - DUB - Split - Unflanged
15.000 -0.000/-0.018	17.000 +0.018/-0.000	15.000 +0.25/-0.25			BP01500-01700-01500-DP4	Bushes - Steel - DP4 - Split - Unflanged
15.000 -0.000/-0.034	17.000 +0.065/-0.000	15.000 +0.25/-0.25			BP01500-01700-01500-DX	Bushes - Steel - DX - Split - Unflanged
15.000 -0.000/-0.034	17.000 +0.065/-0.000	17.000 +0.25/-0.25	23.00	0.80	BF01500-01700-01700-DUB	Bushes - Steel - DUB - Split - Flanged
15.000 -0.000/-0.034	17.000 +0.065/-0.000	17.000 +0.25/-0.25	23.00	1.00	BF01500-01700-01700-SS6	Bushes - Stainless Steel and PTFE - Flanged
15.000 -0.000/-0.018	17.000 +0.018/-0.000	17.000 +0.25/-0.25	23.00	1.00	BF01500-01700-01700-DP4	Bushes - Steel - DP4 - Split - Flanged
15.000 -0.000/-0.034	17.000 +0.065/-0.000	17.000 +0.25/-0.25	23.00	1.00	BF01500-01700-01700-DU	Bushes - Steel - DU - Split - Flanged
15.000 -0.000/-0.018	17.000 +0.018/-0.000	20.000 +0.25/-0.25			BP01500-01700-02000-DP4	Bushes - Steel - DP4 - Split - Unflanged
15.000 -0.000/-0.034	17.000 +0.065/-0.000	20.000 +0.00/-0.30			BP01500-01700-02000-DU	Bushes - Steel - DU - Split - Unflanged
15.000 -0.000/-0.034	17.000 +0.065/-0.000	20.000 +0.00/-0.30			BP01500-01700-02000-SS6	Bushes - Stainless Steel and PTFE - Unflanged

 Stocked or Short Delivery

 Usually Available

 Long delivery or not in current production

ID	OD	B	DF	bf	Part Number	Type
15.000 x 17.000 mm (0.591 x 0.669 in.)						
15.000 -0.000/-0.034	17.000 +0.065/-0.000	25.000 +0.25/-0.25			BP01500-01700-02500-DUB	Bushes - Steel - DUB - Split - Unflanged
15.000 -0.000/-0.034	17.000 +0.065/-0.000	25.000 +0.00/-0.30			BP01500-01700-02500-DU	Bushes - Steel - DU - Split - Unflanged
15.000 -0.000/-0.034	17.000 +0.065/-0.000	25.000 +0.00/-0.30			BP01500-01700-02500-SS6	Bushes - Stainless Steel and PTFE - Unflanged
15.000 -0.000/-0.018	17.000 +0.018/-0.000	25.000 +0.25/-0.25			BP01500-01700-02500-DP4	Bushes - Steel - DP4 - Split - Unflanged
15.000 -0.000/-0.034	17.000 +0.065/-0.000	25.000 +0.25/-0.25			BP01500-01700-02500-DX	Bushes - Steel - DX - Split - Unflanged
15.000 x 19.000 mm (0.591 x 0.748 in.)						
15.000 +0.006/+0.024	19.000 +0.035/+0.056	10.000 +/-0.110			BP01500-01900-01000-BSO	Bushes - Bronze - Sintered - Unflanged - Oilite
15.000 +0.006/+0.024	19.000 +0.035/+0.056	15.000 +/-0.130			BP01500-01900-01500-BSO	Bushes - Bronze - Sintered - Unflanged - Oilite
15.000 +0.006/+0.024	19.000 +0.035/+0.056	25.000 +/-0.160			BP01500-01900-02500-BSO	Bushes - Bronze - Sintered - Unflanged - Oilite
15.000 +0.006/+0.024	19.000 +0.035/+0.056	30.000 +/-0.160			BP01500-01900-03000-BSO	Bushes - Bronze - Sintered - Unflanged - Oilite
15.000 x 21.000 mm (0.591 x 0.827 in.)						
15.000 +0.006/+0.024	21.000 +0.035/+0.056	10.000 +/-0.110	27.00	3.00	BF01500-02100-01000-BSO	Bushes - Bronze - Sintered - Flanged - Oilite
15.000 +0.006/+0.024	21.000 +0.035/+0.056	15.000 +/-0.130			BP01500-02100-01500-BSO	Bushes - Bronze - Sintered - Unflanged - Oilite
15.000 +0.006/+0.024	21.000 +0.035/+0.056	15.000 +/-0.130	27.00	3.00	BF01500-02100-01500-BSO	Bushes - Bronze - Sintered - Flanged - Oilite
15.000 +0.006/+0.024	21.000 +0.035/+0.056	20.000 +/-0.160	27.00	3.00	BF01500-02100-02000-BSO	Bushes - Bronze - Sintered - Flanged - Oilite
15.000 +0.006/+0.024	21.000 +0.035/+0.056	25.000 +/-0.160			BP01500-02100-02500-BSO	Bushes - Bronze - Sintered - Unflanged - Oilite
15.000 +0.006/+0.024	21.000 +0.035/+0.056	25.000 +/-0.160	27.00	3.00	BF01500-02100-02500-BSO	Bushes - Bronze - Sintered - Flanged - Oilite
15.875 x 17.463 mm (0.625 x 0.688 in.)						
15.875 +/-0.0254	17.463 +0.0508/+0.0762	38.100 +/-0.127			BP01588-01746-03810-BLG	Bushes - Bronze - Solid - Leaded Gunmetal
15.875 +/-0.0254	17.463 +0.0508/+0.0762	50.800 +/-0.127			BP01588-01746-05080-BLG	Bushes - Bronze - Solid - Leaded Gunmetal
15.875 x 18.256 mm (0.625 x 0.719 in.)						
15.875 -0.025/-0.051	18.256 +0.011/-0.009	6.350 +0.00/-0.30			BP01588-01826-00635-DU	Bushes - Steel - DU - Split - Unflanged
15.875 -0.025/-0.051	18.256 +0.011/-0.009	6.350 +0.25/-0.25			BP01588-01826-00635-SS6	Bushes - Stainless Steel and PTFE - Unflanged
15.875 -0.025/-0.051	18.256 +0.011/-0.009	6.350 +0.00/-0.30			BP01588-01826-00635-DP4	Bushes - Steel - DP4 - Split - Unflanged
15.875 -0.025/-0.051	18.256 +0.011/-0.009	9.525 +0.25/-0.25	24.32	1.73	BF01588-01826-00953-DP4	Bushes - Steel - DP4 - Split - Flanged
15.875 -0.025/-0.051	18.256 +0.011/-0.009	9.525 +0.25/-0.25	24.32	1.73	BF01588-01826-00953-DU	Bushes - Steel - DU - Split - Flanged
15.875 -0.025/-0.051	18.256 +0.011/-0.009	9.525 +0.25/-0.25	24.32	1.73	BF01588-01826-00953-SS6	Bushes - Stainless Steel and PTFE - Flanged
15.875 -0.025/-0.051	18.256 +0.011/-0.009	12.700 +0.00/-0.30			BP01588-01826-01270-DP4	Bushes - Steel - DP4 - Split - Unflanged
15.875 -0.025/-0.051	18.256 +0.011/-0.009	12.700 +0.25/-0.25			BP01588-01826-01270-SS6	Bushes - Stainless Steel and PTFE - Unflanged
15.875 -0.025/-0.051	18.256 +0.011/-0.009	12.700 +0.00/-0.30			BP01588-01826-01270-DU	Bushes - Steel - DU - Split - Unflanged
15.875 -0.025/-0.051	18.256 +0.011/-0.009	12.700 +0.25/-0.25	24.32	1.73	BF01588-01826-01270-DU	Bushes - Steel - DU - Split - Flanged
15.875 -0.025/-0.051	18.256 +0.011/-0.009	12.700 +0.25/-0.25	24.32	1.73	BF01588-01826-01270-SS6	Bushes - Stainless Steel and PTFE - Flanged
15.875 -0.025/-0.051	18.256 +0.011/-0.009	12.700 +0.25/-0.25	24.32	1.73	BF01588-01826-01270-DP4	Bushes - Steel - DP4 - Split - Flanged
15.875 -0.025/-0.051	18.256 +0.011/-0.009	15.875 +0.00/-0.30			BP01588-01826-01588-DU	Bushes - Steel - DU - Split - Unflanged
15.875 -0.025/-0.051	18.256 +0.011/-0.009	15.875 +0.00/-0.30			BP01588-01826-01588-DP4	Bushes - Steel - DP4 - Split - Unflanged
15.875 -0.025/-0.051	18.256 +0.011/-0.009	15.875 +0.25/-0.25			BP01588-01826-01588-SS6	Bushes - Stainless Steel and PTFE - Unflanged
15.875 -0.025/-0.051	18.256 +0.011/-0.009	15.875 +0.25/-0.25	24.32	1.73	BF01588-01826-01588-SS6	Bushes - Stainless Steel and PTFE - Flanged
15.875 -0.025/-0.051	18.256 +0.011/-0.009	15.875 +0.25/-0.25	24.32	1.73	BF01588-01826-01588-DU	Bushes - Steel - DU - Split - Flanged
15.875 -0.025/-0.051	18.256 +0.011/-0.009	15.875 +0.25/-0.25	24.32	1.73	BF01588-01826-01588-DP4	Bushes - Steel - DP4 - Split - Flanged
15.875 -0.025/-0.051	18.256 +0.011/-0.009	19.050 +0.00/-0.30			BP01588-01826-01905-DU	Bushes - Steel - DU - Split - Unflanged

 Stocked or Short Delivery

 Usually Available

 Long delivery or not in current production

ID	OD	B	DF	bf	Part Number	Type
----	----	---	----	----	-------------	------

15.875 x 18.256 mm (0.625 x 0.719 in.)						
15.875 -0.025/-0.051	18.256 +0.011/-0.009	19.050 +0.00/-0.30			BP01588-01826-01905-DP4	Bushes - Steel - DP4 - Split - Unflanged
15.875 -0.025/-0.051	18.256 +0.011/-0.009	19.050 +0.25/-0.25			BP01588-01826-01905-SS6	Bushes - Stainless Steel and PTFE - Unflanged
15.875 -0.025/-0.051	18.256 +0.011/-0.009	19.050 +0.25/-0.25	24.32	1.73	BF01588-01826-01905-SS6	Bushes - Stainless Steel and PTFE - Flanged
15.875 -0.025/-0.051	18.256 +0.011/-0.009	19.050 +0.25/-0.25	24.32	1.73	BF01588-01826-01905-DU	Bushes - Steel - DU - Split - Flanged
15.875 -0.025/-0.051	18.256 +0.011/-0.009	19.050 +0.25/-0.25	24.32	1.73	BF01588-01826-01905-DP4	Bushes - Steel - DP4 - Split - Flanged
15.875 -0.025/-0.051	18.256 +0.011/-0.009	22.225 +0.25/-0.25			BP01588-01826-02223-SS6	Bushes - Stainless Steel and PTFE - Unflanged
15.875 -0.025/-0.051	18.256 +0.011/-0.009	22.225 +0.00/-0.30			BP01588-01826-02223-DU	Bushes - Steel - DU - Split - Unflanged
15.875 -0.025/-0.051	18.256 +0.011/-0.009	22.225 +0.00/-0.30			BP01588-01826-02223-DP4	Bushes - Steel - DP4 - Split - Unflanged
15.875 -0.025/-0.051	18.256 +0.011/-0.009	25.400 +0.00/-0.30			BP01588-01826-02540-DU	Bushes - Steel - DU - Split - Unflanged
15.875 -0.025/-0.051	18.256 +0.011/-0.009	25.400 +0.00/-0.30			BP01588-01826-02540-DP4	Bushes - Steel - DP4 - Split - Unflanged
15.875 -0.025/-0.051	18.256 +0.011/-0.009	25.400 +0.25/-0.25			BP01588-01826-02540-SS6	Bushes - Stainless Steel and PTFE - Unflanged

15.875 x 19.050 mm (0.625 x 0.750 in.)						
15.875 +0.025/+0.051	19.050 +0.064/+0.089	5.842 +/-0.127	22.23	3.68	BF01588-01905-00584-BS	Bushes - Bronze - Sintered - Flanged
15.875 +0.050/+0.076	19.050 +0.051/+0.076	8.712 +/-0.127			BP01588-01905-00871-BS	Bushes - Bronze - Sintered - Unflanged
15.875 +0.025/+0.051	19.050 +0.064/+0.089	9.423 +/-0.127	25.17	1.60	BF01588-01905-00942-BS	Bushes - Bronze - Sintered - Flanged
15.875 +0.050/+0.076	19.050 +0.064/+0.089	9.474 +/-0.127			BP01588-01905-00947-BS	Bushes - Bronze - Sintered - Unflanged
15.875 +0.050/+0.076	19.050 +0.064/+0.089	11.049 +/-0.127			BP01588-01905-01105-BS	Bushes - Bronze - Sintered - Unflanged
15.875 +0.025/+0.050	19.050 +0.051/+0.076	12.700 +/-0.127			BP01588-01905-01270-BS	Bushes - Bronze - Sintered - Unflanged
15.875 +0.006/+0.024	19.050 +0.035/+0.056	12.700 +/-0.130			BP01588-01905-01270-BSO	Bushes - Bronze - Sintered - Unflanged - Oilite
15.875 +0.0254/+0.0508	19.050 +0.0508/+0.0762	12.700 +0.127/-0.127			BP01588-01905-01270-BFG	Bushes - Bronze - Sintered - ECO841 Food Grade - Unflanged
15.875 +/-0.0254	19.050 +0.0508/+0.0762	12.700 +/-0.127			BP01588-01905-01270-BC9	Bushes - Bronze - Solid - Leaded Gunmetal
15.875 +0/-0.025	19.050 +0.051/+0.076	12.700 +/-0.127	25.40	3.18	BF01588-01905-01270-BS	Bushes - Bronze - Sintered - Flanged
15.875 +0.006/+0.024	19.050 +0.035/+0.056	12.700 +/-0.130	28.58	2.39	BF01588-01905-01270-BSO	Bushes - Bronze - Sintered - Flanged - Oilite
15.875 +0.025/+0.050	19.050 +0.051/+0.076	15.875 +/-0.127			BP01588-01905-01588-BS	Bushes - Bronze - Sintered - Unflanged
15.875 +0.006/+0.024	19.050 +0.035/+0.056	15.875 +/-0.130			BP01588-01905-01588-BSO	Bushes - Bronze - Sintered - Unflanged - Oilite
15.875 +0.0254/+0.0508	19.050 +0.0508/+0.0762	15.875 +0.127/-0.127			BP01588-01905-01588-BFG	Bushes - Bronze - Sintered - ECO841 Food Grade - Unflanged
15.875 +0/-0.025	19.050 +0.051/+0.076	15.875 +/-0.127	25.40	3.18	BF01588-01905-01588-BS	Bushes - Bronze - Sintered - Flanged
15.875 +0.025/+0.051	19.050 +0.064/+0.089	16.002 +/-0.127	25.17	1.60	BF01588-01905-01600-BS	Bushes - Bronze - Sintered - Flanged
15.875 +0.025/+0.050	19.050 +0.051/+0.076	19.050 +/-0.127			BP01588-01905-01905-BS	Bushes - Bronze - Sintered - Unflanged
15.875 +0.006/+0.024	19.050 +0.035/+0.056	19.050 +/-0.160			BP01588-01905-01905-BSO	Bushes - Bronze - Sintered - Unflanged - Oilite
15.875 +0.0254/+0.0508	19.050 +0.0508/+0.0762	19.050 +0.127/-0.127			BP01588-01905-01905-BFG	Bushes - Bronze - Sintered - ECO841 Food Grade - Unflanged
15.875 +/-0.0254	19.050 +0.0508/+0.0762	19.050 +/-0.127			BP01588-01905-01905-BC9	Bushes - Bronze - Solid - Leaded Gunmetal
15.875 +/-0.0254	19.050 +0.0508/+0.0762	19.050 +/-0.127			BP01588-01905-01905-BLG	Bushes - Bronze - Solid - Leaded Gunmetal
15.875 +0/-0.025	19.050 +0.051/+0.076	19.050 +/-0.127	25.40	3.18	BF01588-01905-01905-BS	Bushes - Bronze - Sintered - Flanged
15.875 +0.050/+0.076	19.050 +0.064/+0.089	19.329 +0/-0.127			BP01588-01905-01933-BS	Bushes - Bronze - Sintered - Unflanged
15.875 +0.025/+0.050	19.050 +0.051/+0.076	22.225 +/-0.127			BP01588-01905-02223-BS	Bushes - Bronze - Sintered - Unflanged
15.875 +0.0254/+0.0508	19.050 +0.0508/+0.0762	22.225 +0.127/-0.127			BP01588-01905-02223-BFG	Bushes - Bronze - Sintered - ECO841 Food Grade - Unflanged
15.875 +0.006/+0.024	19.050 +0.035/+0.056	22.225 +/-0.160			BP01588-01905-02223-BSO	Bushes - Bronze - Sintered - Unflanged - Oilite
15.875 +0.025/-0	19.050 +0.025/+0.076	25.400 +/-0.397			BP01588-01905-02540-BS02	Bushes - Bronze - Sintered - Unflanged

Stocked or Short Delivery

Usually Available

Long delivery or not in current production

ID	OD	B	DF	bf	Part Number	Type
15.875 x 19.050 mm (0.625 x 0.750 in.)						
15.875 +0.025/+0.050	19.050 +0.051/+0.076	25.400 +/-0.127			BP01588-01905-02540-BS05	Bushes - Bronze - Sintered - Unflanged
15.875 +0.0254/+0.0508	19.050 +0.0508/+0.0762	25.400 +0.127/-0.127			BP01588-01905-02540-BFG	Bushes - Bronze - Sintered - ECO841 Food Grade - Unflanged
15.875 +0.006/+0.024	19.050 +0.035/+0.056	25.400 +/-0.160			BP01588-01905-02540-BSO	Bushes - Bronze - Sintered - Unflanged - Oilite
15.875 +/-0.0254	19.050 +0.0508/+0.0762	25.400 +/-0.127			BP01588-01905-02540-BC9	Bushes - Bronze - Solid - Leaded Gunmetal
15.875 +/-0.0254	19.050 +0.0508/+0.0762	25.400 +/-0.127			BP01588-01905-02540-BLG	Bushes - Bronze - Solid - Leaded Gunmetal
15.875 +0.013/+0.038	19.050 +0.039/+0.064	25.400 +/-0.127	25.40	2.38	BF01588-01905-02540-BS04	Bushes - Bronze - Sintered - Flanged
15.875 +0.006/+0.024	19.050 +0.035/+0.056	25.400 +/-0.160	28.58	2.39	BF01588-01905-02540-BSO	Bushes - Bronze - Sintered - Flanged - Oilite
15.875 +0.025/-0	19.050 +0.025/+0.076	28.575 +/-0.397			BP01588-01905-02858-BS02	Bushes - Bronze - Sintered - Unflanged
15.875 +0.025/+0.050	19.050 +0.051/+0.076	28.575 +/-0.127			BP01588-01905-02858-BS05	Bushes - Bronze - Sintered - Unflanged
15.875 +0.025/+0.050	19.050 +0.051/+0.076	31.750 +/-0.127			BP01588-01905-03175-BS	Bushes - Bronze - Sintered - Unflanged
15.875 +0.0254/+0.0508	19.050 +0.0508/+0.0762	31.750 +0.127/-0.127			BP01588-01905-03175-BFG	Bushes - Bronze - Sintered - ECO841 Food Grade - Unflanged
15.875 +/-0.0254	19.050 +0.0508/+0.0762	31.750 +/-0.127			BP01588-01905-03175-BC9	Bushes - Bronze - Solid - Leaded Gunmetal
15.875 +/-0.0254	19.050 +0.0508/+0.0762	31.750 +/-0.127			BP01588-01905-03175-BLG	Bushes - Bronze - Solid - Leaded Gunmetal
15.875 +0/-0.025	19.050 +0.051/+0.076	31.750 +/-0.127	25.40	3.18	BF01588-01905-03175-BS	Bushes - Bronze - Sintered - Flanged
15.875 +0.025/+0.050	19.050 +0.051/+0.076	38.100 +/-0.127			BP01588-01905-03810-BS	Bushes - Bronze - Sintered - Unflanged
15.875 +/-0.0254	19.050 +0.0508/+0.0762	38.100 +/-0.127			BP01588-01905-03810-BC9	Bushes - Bronze - Solid - Leaded Gunmetal
15.875 +/-0.0254	19.050 +0.0508/+0.0762	38.100 +/-0.127			BP01588-01905-03810-BLG	Bushes - Bronze - Solid - Leaded Gunmetal
15.875 +/-0.0254	19.050 +0.0508/+0.0762	44.450 +/-0.127			BP01588-01905-04445-BC9	Bushes - Bronze - Solid - Leaded Gunmetal
15.875 +/-0.0254	19.050 +0.0508/+0.0762	44.450 +/-0.127			BP01588-01905-04445-BLG	Bushes - Bronze - Solid - Leaded Gunmetal
15.875 +/-0.0254	19.050 +0.0508/+0.0762	50.800 +/-0.127			BP01588-01905-05080-BC9	Bushes - Bronze - Solid - Leaded Gunmetal
15.875 +/-0.0254	19.050 +0.0508/+0.0762	50.800 +/-0.127			BP01588-01905-05080-BLG	Bushes - Bronze - Solid - Leaded Gunmetal
15.875 +/-0.0254	19.050 +0.0508/+0.0762	57.150 +/-0.127			BP01588-01905-05715-BLG	Bushes - Bronze - Solid - Leaded Gunmetal
15.875 +/-0.0254	19.050 +0.0508/+0.0762	63.500 +/-0.127			BP01588-01905-06350-BLG	Bushes - Bronze - Solid - Leaded Gunmetal
15.875 +/-0.0254	19.050 +0.0508/+0.0762	76.200 +/-0.127			BP01588-01905-07620-BLG	Bushes - Bronze - Solid - Leaded Gunmetal

15.875 x 20.638 mm (0.625 x 0.813 in.)						
15.875 +0.0254/+0.0508	20.638 +0.0508/+0.0762	12.700 +0.127/-0.127			BP01588-02064-01270-BS	Bushes - Bronze - Sintered - Unflanged
15.875 +0.0254/+0.0508	20.638 +0.0508/+0.0762	12.700 +0.127/-0.127			BP01588-02064-01270-BFG	Bushes - Bronze - Sintered - ECO841 Food Grade - Unflanged
15.875 +0.025/-0	20.638 +0.039/+0.064	12.700 +/-0.127	25.40	3.18	BF01588-02064-01270-BS	Bushes - Bronze - Sintered - Flanged
15.875 +0.025/+0.050	20.638 +0.039/+0.064	15.875 +/-0.127			BP01588-02064-01588-BS	Bushes - Bronze - Sintered - Unflanged
15.875 +0.0254/+0.0508	20.638 +0.0508/+0.0762	19.050 +0.127/-0.127			BP01588-02064-01905-BS	Bushes - Bronze - Sintered - Unflanged
15.875 +0.0254/+0.0508	20.638 +0.0508/+0.0762	19.050 +0.127/-0.127			BP01588-02064-01905-BFG	Bushes - Bronze - Sintered - ECO841 Food Grade - Unflanged
15.875 +0.025/+0.050	20.638 +0.039/+0.064	19.050 +/-0.127	26.99	3.97	BF01588-02064-01905-BS	Bushes - Bronze - Sintered - Flanged
15.875 +0.025/+0.050	20.638 +0.039/+0.064	22.225 +/-0.127			BP01588-02064-02223-BS	Bushes - Bronze - Sintered - Unflanged
15.875 +0.0254/+0.0508	20.638 +0.0508/+0.0762	25.400 +0.127/-0.127			BP01588-02064-02540-BS	Bushes - Bronze - Sintered - Unflanged
15.875 +/-0.0254	20.638 +0.0508/+0.0762	25.400 +/-0.127			BP01588-02064-02540-BC9	Bushes - Bronze - Solid - Leaded Gunmetal
15.875 +/-0.0254	20.638 +0.0508/+0.0762	25.400 +/-0.127			BP01588-02064-02540-BLG	Bushes - Bronze - Solid - Leaded Gunmetal
15.875 +0.025/+0.050	20.638 +0.039/+0.064	25.400 +/-0.127	26.99	3.97	BF01588-02064-02540-BS	Bushes - Bronze - Sintered - Flanged
15.875 +0.025/+0.050	20.638 +0.039/+0.064	31.750 +/-0.127			BP01588-02064-03175-BS	Bushes - Bronze - Sintered - Unflanged
15.875 +0.025/+0.050	20.638 +0.039/+0.064	31.750 +/-0.127	26.99	3.97	BF01588-02064-03175-BS	Bushes - Bronze - Sintered - Flanged

Stocked or Short Delivery

Usually Available

Long delivery or not in current production

ID	OD	B	DF	bf	Part Number	Type
15.875 x 20.638 mm (0.625 x 0.813 in.)						
15.875 +0.025/+0.050	20.638 +0.039/+0.064	36.512 +/-0.127	26.99	3.97	BF01588-02064-03651-BS	Bushes - Bronze - Sintered - Flanged
15.875 +0.025/+0.050	20.638 +0.039/+0.064	38.100 +/-0.127			BP01588-02064-03810-BS	Bushes - Bronze - Sintered - Unflanged
15.875 +/-0.0254	20.638 +0.0508/+0.0762	38.100 +/-0.127			BP01588-02064-03810-BLG	Bushes - Bronze - Solid - Leaded Gunmetal
15.875 +0.025/+0.050	20.638 +0.039/+0.064	38.100 +/-0.127	26.99	3.97	BF01588-02064-03810-BS	Bushes - Bronze - Sintered - Flanged
15.875 +0.025/+0.050	20.638 +0.039/+0.064	44.450 +/-0.190			BP01588-02064-04445-BS	Bushes - Bronze - Sintered - Unflanged
15.875 +/-0.0254	20.638 +0.0508/+0.0762	50.800 +/-0.127			BP01588-02064-05080-BLG	Bushes - Bronze - Solid - Leaded Gunmetal
15.875 +0.025/+0.050	20.638 +0.039/+0.064	50.800 +/-0.190	26.99	3.97	BF01588-02064-05080-BS	Bushes - Bronze - Sintered - Flanged
15.875 +/-0.0254	20.638 +0.0508/+0.0762	63.500 +/-0.127			BP01588-02064-06350-BLG	Bushes - Bronze - Solid - Leaded Gunmetal
15.875 x 22.225 mm (0.625 x 0.875 in.)						
15.875 +0.050/+0.076	22.225 +0.064/+0.089	8.204 +/-0.127			BP01588-02223-00820-BS	Bushes - Bronze - Sintered - Unflanged
15.875 +0.025/+0.050	22.225 +0.051/+0.076	12.700 +/-0.127			BP01588-02223-01270-BS05	Bushes - Bronze - Sintered - Unflanged
15.875 +0.050/+0.076	22.225 +0.064/+0.089	12.700 +/-0.127			BP01588-02223-01270-BS08	Bushes - Bronze - Sintered - Unflanged
15.875 +0.0254/+0.0508	22.225 +0.0508/+0.0762	12.700 +0.127/-0.127			BP01588-02223-01270-BS	Bushes - Bronze - Sintered - Unflanged
15.875 +0.0254/+0.0508	22.225 +0.0508/+0.0762	12.700 +0.127/-0.127			BP01588-02223-01270-BFG	Bushes - Bronze - Sintered - ECO841 Food Grade - Unflanged
15.875 +0.006/+0.024	22.225 +0.035/+0.056	12.700 +/-0.130	31.75	3.18	BF01588-02223-01270-BSO	Bushes - Bronze - Sintered - Flanged - Oilite
15.875 +0.0254/+0.0508	22.225 +0.0508/+0.0762	15.875 +0.127/-0.127			BP01588-02223-01588-BS	Bushes - Bronze - Sintered - Unflanged
15.875 +0.025/+0.050	22.225 +0.051/+0.076	15.875 +/-0.127			BP01588-02223-01588-BS05	Bushes - Bronze - Sintered - Unflanged
15.875 +0.050/+0.076	22.225 +0.064/+0.089	15.875 +/-0.127			BP01588-02223-01588-BS08	Bushes - Bronze - Sintered - Unflanged
15.875 +0.0254/+0.0508	22.225 +0.0508/+0.0762	15.875 +0.127/-0.127			BP01588-02223-01588-BFG	Bushes - Bronze - Sintered - ECO841 Food Grade - Unflanged
15.875 +0.0254/+0.0508	22.225 +0.0508/+0.0762	19.050 +0.127/-0.127			BP01588-02223-01905-BS	Bushes - Bronze - Sintered - Unflanged
15.875 +0.038/+0.063	22.225 +0.025/+0.050	19.050 +0.00/-0.51			BP01588-02223-01905-AF	Bushes - Aluminium - Frelon Lined - Unflanged
15.875 +0.006/+0.024	22.225 +0.035/+0.056	19.050 +/-0.160			BP01588-02223-01905-BSO	Bushes - Bronze - Sintered - Unflanged - Oilite
15.875 +0.0254/+0.0508	22.225 +0.0508/+0.0762	19.050 +0.127/-0.127			BP01588-02223-01905-BFG	Bushes - Bronze - Sintered - ECO841 Food Grade - Unflanged
15.875 +/-0.0254	22.225 +0.0508/+0.0762	19.050 +/-0.127			BP01588-02223-01905-BC9	Bushes - Bronze - Solid - Leaded Gunmetal
15.875 +/-0.0254	22.225 +0.0508/+0.0762	19.050 +/-0.127			BP01588-02223-01905-BLG	Bushes - Bronze - Solid - Leaded Gunmetal
15.875 +0.038/+0.063	22.225 +0.025/+0.050	19.050 +0.00/-0.51	25.40	3.18	BF01588-02223-01905-AF	Bushes - Aluminium - Frelon Lined - Flanged
15.875 +0.025/+0.050	22.225 +0.051/+0.076	19.050 +/-0.127	28.58	3.97	BF01588-02223-01905-BS	Bushes - Bronze - Sintered - Flanged
15.875 +0.006/+0.024	22.225 +0.035/+0.056	19.050 +/-0.160	31.75	3.18	BF01588-02223-01905-BSO	Bushes - Bronze - Sintered - Flanged - Oilite
15.875 +0.025/+0.050	22.225 +0.051/+0.076	22.225 +/-0.127			BP01588-02223-02223-BS	Bushes - Bronze - Sintered - Unflanged
15.875 +0.006/+0.024	22.225 +0.035/+0.056	22.225 +/-0.160			BP01588-02223-02223-BSO	Bushes - Bronze - Sintered - Unflanged - Oilite
15.875 +0.0254/+0.0508	22.225 +0.0508/+0.0762	25.400 +0.127/-0.127			BP01588-02223-02540-BS	Bushes - Bronze - Sintered - Unflanged
15.875 +0.038/+0.063	22.225 +0.025/+0.050	25.400 +0.00/-0.51			BP01588-02223-02540-AF	Bushes - Aluminium - Frelon Lined - Unflanged
15.875 +0.006/+0.024	22.225 +0.035/+0.056	25.400 +/-0.160			BP01588-02223-02540-BSO	Bushes - Bronze - Sintered - Unflanged - Oilite
15.875 +0.0254/+0.0508	22.225 +0.0508/+0.0762	25.400 +0.127/-0.127			BP01588-02223-02540-BFG	Bushes - Bronze - Sintered - ECO841 Food Grade - Unflanged
15.875 +/-0.0254	22.225 +0.0508/+0.0762	25.400 +/-0.127			BP01588-02223-02540-BC9	Bushes - Bronze - Solid - Leaded Gunmetal
15.875 +/-0.0254	22.225 +0.0508/+0.0762	25.400 +/-0.127			BP01588-02223-02540-BLG	Bushes - Bronze - Solid - Leaded Gunmetal
15.875 +0.038/+0.063	22.225 +0.025/+0.050	25.400 +0.00/-0.51	25.40	3.18	BF01588-02223-02540-AF	Bushes - Aluminium - Frelon Lined - Flanged
15.875 +0.025/+0.050	22.225 +0.051/+0.076	25.400 +/-0.127	28.58	3.97	BF01588-02223-02540-BS	Bushes - Bronze - Sintered - Flanged
15.875 +0.006/+0.024	22.225 +0.035/+0.056	25.400 +/-0.160	31.75	3.18	BF01588-02223-02540-BSO	Bushes - Bronze - Sintered - Flanged - Oilite

Stocked or Short Delivery

Usually Available

Long delivery or not in current production

ID	OD	B	DF	bf	Part Number	Type
----	----	---	----	----	-------------	------

15.875 x 22.225 mm (0.625 x 0.875 in.)						
15.875 +0.025/+0.050	22.225 +0.051/+0.076	28.575 +/-0.127			BP01588-02223-02858-BS	Bushes - Bronze - Sintered - Unflanged
15.875 +0.006/+0.024	22.225 +0.035/+0.056	31.750 +/-0.190			BP01588-02223-03175-BSO	Bushes - Bronze - Sintered - Unflanged - Oilite
15.875 +0.025/+0.050	22.225 +0.051/+0.076	31.750 +/-0.127			BP01588-02223-03175-BS	Bushes - Bronze - Sintered - Unflanged
15.875 +/-0.0254	22.225 +0.0508/+0.0762	31.750 +/-0.127			BP01588-02223-03175-BLG	Bushes - Bronze - Solid - Leaded Gunmetal
15.875 +0.025/+0.050	22.225 +0.051/+0.076	38.100 +/-0.127			BP01588-02223-03810-BS	Bushes - Bronze - Sintered - Unflanged
15.875 +/-0.0254	22.225 +0.0508/+0.0762	38.100 +/-0.127			BP01588-02223-03810-BLG	Bushes - Bronze - Solid - Leaded Gunmetal
15.875 +0.025/+0.050	22.225 +0.051/+0.076	44.450 +/-0.190			BP01588-02223-04445-BS	Bushes - Bronze - Sintered - Unflanged
15.875 +/-0.0254	22.225 +0.0508/+0.0762	44.450 +/-0.127			BP01588-02223-04445-BLG	Bushes - Bronze - Solid - Leaded Gunmetal
15.875 +0.025/+0.050	22.225 +0.051/+0.076	44.450 +/-0.190	28.58	3.97	BF01588-02223-04445-BS	Bushes - Bronze - Sintered - Flanged
15.875 +0.025/+0.050	22.225 +0.051/+0.076	50.800 +/-0.190			BP01588-02223-05080-BS	Bushes - Bronze - Sintered - Unflanged
15.875 +/-0.0254	22.225 +0.0508/+0.0762	50.800 +/-0.127			BP01588-02223-05080-BLG	Bushes - Bronze - Solid - Leaded Gunmetal
15.875 +/-0.0254	22.225 +0.0508/+0.0762	57.150 +/-0.127			BP01588-02223-05715-BLG	Bushes - Bronze - Solid - Leaded Gunmetal
15.875 +/-0.0254	22.225 +0.0508/+0.0762	63.500 +/-0.127			BP01588-02223-06350-BLG	Bushes - Bronze - Solid - Leaded Gunmetal
15.875 +/-0.0254	22.225 +0.0508/+0.0762	76.200 +/-0.127			BP01588-02223-07620-BLG	Bushes - Bronze - Solid - Leaded Gunmetal

15.875 x 23.813 mm (0.625 x 0.938 in.)						
15.875 +0.025/+0.050	23.813 +0.063/+0.088	15.875 +/-0.127			BP01588-02381-01588-BS	Bushes - Bronze - Sintered - Unflanged
15.875 +0.025/+0.050	23.813 +0.063/+0.088	19.050 +/-0.127			BP01588-02381-01905-BS	Bushes - Bronze - Sintered - Unflanged
15.875 +0.025/+0.050	23.813 +0.063/+0.088	25.400 +/-0.127			BP01588-02381-02540-BS	Bushes - Bronze - Sintered - Unflanged

15.875 x 25.400 mm (0.625 x 1.000 in.)						
15.875 +0.025/+0.050	25.400 +0.051/+0.076	12.700 +/-0.127			BP01588-02540-01270-BS	Bushes - Bronze - Sintered - Unflanged
15.875 +0.025/+0.050	25.400 +0.051/+0.076	15.875 +/-0.127			BP01588-02540-01588-BS	Bushes - Bronze - Sintered - Unflanged
15.875 +0.025/+0.050	25.400 +0.051/+0.076	19.050 +/-0.127			BP01588-02540-01905-BS	Bushes - Bronze - Sintered - Unflanged
15.875 +0.025/+0.050	25.400 +0.051/+0.076	22.225 +/-0.127			BP01588-02540-02223-BS	Bushes - Bronze - Sintered - Unflanged
15.875 +0.025/+0.050	25.400 +0.051/+0.076	25.400 +/-0.127			BP01588-02540-02540-BS	Bushes - Bronze - Sintered - Unflanged
15.875 +/-0.0254	25.400 +0.0508/+0.0762	25.400 +/-0.127			BP01588-02540-02540-BC9	Bushes - Bronze - Solid - Leaded Gunmetal
15.875 +0.025/+0.050	25.400 +0.051/+0.076	31.750 +/-0.127			BP01588-02540-03175-BS	Bushes - Bronze - Sintered - Unflanged
15.875 +/-0.0254	25.400 +0.0508/+0.0762	31.750 +/-0.127			BP01588-02540-03175-BLG	Bushes - Bronze - Solid - Leaded Gunmetal
15.875 +0.025/+0.050	25.400 +0.051/+0.076	38.100 +/-0.127			BP01588-02540-03810-BS	Bushes - Bronze - Sintered - Unflanged
15.875 +0.025/+0.050	25.400 +0.051/+0.076	44.450 +/-0.190			BP01588-02540-04445-BS	Bushes - Bronze - Sintered - Unflanged
15.875 +0.025/+0.050	25.400 +0.051/+0.076	50.800 +/-0.190			BP01588-02540-05080-BS	Bushes - Bronze - Sintered - Unflanged
15.875 +/-0.0254	25.400 +0.0508/+0.0762	50.800 +/-0.127			BP01588-02540-05080-BC9	Bushes - Bronze - Solid - Leaded Gunmetal
15.875 +/-0.0254	25.400 +0.0508/+0.0762	50.800 +/-0.127			BP01588-02540-05080-BLG	Bushes - Bronze - Solid - Leaded Gunmetal
15.875 +/-0.0254	25.400 +0.0508/+0.0762	63.500 +/-0.127			BP01588-02540-06350-BLG	Bushes - Bronze - Solid - Leaded Gunmetal

15.875 x 28.575 mm (0.625 x 1.125 in.)						
15.875 +/-0.0254	28.575 +0.0508/+0.0762	38.100 +/-0.127			BP01588-02858-03810-BC9	Bushes - Bronze - Solid - Leaded Gunmetal

16.000 x 18.000 mm (0.630 x 0.709 in.)						
16.000 -0.000/-0.018	18.000 +0.018/-0.000	10.000 +0.25/-0.25			BP01600-01800-01000-DP4	Bushes - Steel - DP4 - Split - Unflanged
16.000 -0.000/-0.018	18.000 +0.065/-0.000	10.000 +0.00/-0.30			BP01600-01800-01000-DU	Bushes - Steel - DU - Split - Unflanged
16.000 -0.000/-0.034	18.000 +0.065/-0.000	10.000 +0.00/-0.30			BP01600-01800-01000-SS6	Bushes - Stainless Steel and PTFE - Unflanged
16.000 -0.000/-0.018	18.000 +0.065/-0.000	12.000 +0.00/-0.30			BP01600-01800-01200-DU	Bushes - Steel - DU - Split - Unflanged

 Stocked or Short Delivery

 Usually Available

 Long delivery or not in current production

ID	OD	B	DF	bf	Part Number	Type
16.000 x 18.000 mm (0.630 x 0.709 in.)						
16.000 -0.000/-0.034	18.000 +0.065/-0.000	12.000 +0.00/-0.30			BP01600-01800-01200-SS6	Bushes - Stainless Steel and PTFE - Unflanged
16.000 -0.000/-0.018	18.000 +0.018/-0.000	12.000 +0.25/-0.25			BP01600-01800-01200-DP4	Bushes - Steel - DP4 - Split - Unflanged
16.000 -0.000/-0.034	18.000 +0.065/-0.000	12.000 +0.25/-0.25	24.00	0.80	BF01600-01800-01200-DUB	Bushes - Steel - DUB - Split - Flanged
16.000 -0.000/-0.034	18.000 +0.065/-0.000	12.000 +0.25/-0.25	24.00	1.00	BF01600-01800-01200-SS6	Bushes - Stainless Steel and PTFE - Flanged
16.000 -0.000/-0.034	18.000 +0.065/-0.000	12.000 +0.25/-0.25	24.00	1.00	BF01600-01800-01200-DU	Bushes - Steel - DU - Split - Flanged
16.000 -0.000/-0.018	18.000 +0.018/-0.000	12.000 +0.25/-0.25	24.00	1.00	BF01600-01800-01200-DP4	Bushes - Steel - DP4 - Split - Flanged
16.000 -0.000/-0.034	18.000 +0.065/-0.000	15.000 +0.25/-0.25			BP01600-01800-01500-DUB	Bushes - Steel - DUB - Split - Unflanged
16.000 -0.000/-0.018	18.000 +0.018/-0.000	15.000 +0.25/-0.25			BP01600-01800-01500-DP4	Bushes - Steel - DP4 - Split - Unflanged
16.000 -0.000/-0.018	18.000 +0.065/-0.000	15.000 +0.00/-0.30			BP01600-01800-01500-DU	Bushes - Steel - DU - Split - Unflanged
16.000 -0.000/-0.034	18.000 +0.065/-0.000	15.000 +0.00/-0.30			BP01600-01800-01500-SS6	Bushes - Stainless Steel and PTFE - Unflanged
16.000 -0.000/-0.034	18.000 +0.065/-0.000	15.000 +0.25/-0.25			BP01600-01800-01500-DX	Bushes - Steel - DX - Split - Unflanged
16.000 -0.000/-0.034	18.000 +0.065/-0.000	17.000 +0.25/-0.25	24.00	0.80	BF01600-01800-01700-DUB	Bushes - Steel - DUB - Split - Flanged
16.000 -0.000/-0.018	18.000 +0.018/-0.000	17.000 +0.25/-0.25	24.00	1.00	BF01600-01800-01700-DP4	Bushes - Steel - DP4 - Split - Flanged
16.000 -0.000/-0.034	18.000 +0.075/-0.000	17.000 +0.25/-0.25	24.00	1.00	BF01600-01800-01700-DU	Bushes - Steel - DU - Split - Flanged
16.000 -0.000/-0.034	18.000 +0.065/-0.000	17.000 +0.25/-0.25	24.00	1.00	BF01600-01800-01700-SS6	Bushes - Stainless Steel and PTFE - Flanged
16.000 -0.000/-0.018	18.000 +0.065/-0.000	20.000 +0.00/-0.30			BP01600-01800-02000-DU	Bushes - Steel - DU - Split - Unflanged
16.000 -0.000/-0.018	18.000 +0.018/-0.000	20.000 +0.25/-0.25			BP01600-01800-02000-DP4	Bushes - Steel - DP4 - Split - Unflanged
16.000 -0.000/-0.034	18.000 +0.065/-0.000	20.000 +0.00/-0.30			BP01600-01800-02000-SS6	Bushes - Stainless Steel and PTFE - Unflanged
16.000 -0.000/-0.018	18.000 +0.065/-0.000	20.000 +0.25/-0.25			BP01600-01800-02000-DX	Bushes - Steel - DX - Split - Unflanged
16.000 -0.000/-0.018	18.000 +0.065/-0.000	25.000 +0.00/-0.30			BP01600-01800-02500-DU	Bushes - Steel - DU - Split - Unflanged
16.000 -0.000/-0.018	18.000 +0.018/-0.000	25.000 +0.25/-0.25			BP01600-01800-02500-DP4	Bushes - Steel - DP4 - Split - Unflanged
16.000 -0.000/-0.034	18.000 +0.065/-0.000	25.000 +0.00/-0.30			BP01600-01800-02500-SS6	Bushes - Stainless Steel and PTFE - Unflanged
16.000 -0.000/-0.034	18.000 +0.065/-0.000	25.000 +0.25/-0.25			BP01600-01800-02500-DUB	Bushes - Steel - DUB - Split - Unflanged
16.000 -0.000/-0.034	18.000 +0.065/-0.000	25.000 +0.25/-0.25			BP01600-01800-02500-DX	Bushes - Steel - DX - Split - Unflanged

16.000 x 20.000 mm (0.630 x 0.787 in.)						
16.000 +0.006/+0.024	20.000 +0.035/+0.056	12.000 +/-0.130			BP01600-02000-01200-BSO	Bushes - Bronze - Sintered - Unflanged - Oilite
16.000 +0.006/+0.024	20.000 +0.035/+0.056	16.000 +/-0.130			BP01600-02000-01600-BSO	Bushes - Bronze - Sintered - Unflanged - Oilite
16.000 +0.006/+0.024	20.000 +0.035/+0.056	16.000 +/-0.130	27.00	3.00	BF01600-02000-01600-BSO	Bushes - Bronze - Sintered - Flanged - Oilite
16.000 +/-0.0254	20.000 +0.0508/+0.0762	20.000 +/-0.127			BP01600-02000-02000-BLG	Bushes - Bronze - Solid - Leaded Gunmetal
16.000 +0.006/+0.024	20.000 +0.035/+0.056	20.000 +/-0.160	27.00	3.00	BF01600-02000-02000-BSO	Bushes - Bronze - Sintered - Flanged - Oilite
16.000 +0.006/+0.024	20.000 +0.035/+0.056	25.000 +/-0.160			BP01600-02000-02500-BSO	Bushes - Bronze - Sintered - Unflanged - Oilite
16.000 +0.006/+0.024	20.000 +0.035/+0.056	25.000 +/-0.160	27.00	3.00	BF01600-02000-02500-BSO	Bushes - Bronze - Sintered - Flanged - Oilite
16.000 +/-0.0254	20.000 +0.0508/+0.0762	30.000 +/-0.127			BP01600-02000-03000-BLG	Bushes - Bronze - Solid - Leaded Gunmetal
16.000 +/-0.0254	20.000 +0.0508/+0.0762	40.000 +/-0.127			BP01600-02000-04000-BLG	Bushes - Bronze - Solid - Leaded Gunmetal
16.000 +/-0.0254	20.000 +0.0508/+0.0762	50.000 +/-0.127			BP01600-02000-05000-BLG	Bushes - Bronze - Solid - Leaded Gunmetal
16.000 +/-0.0254	20.000 +0.0508/+0.0762	60.000 +/-0.127			BP01600-02000-06000-BLG	Bushes - Bronze - Solid - Leaded Gunmetal

16.000 x 22.000 mm (0.630 x 0.866 in.)						
16.000 +0.006/+0.024	22.000 +0.035/+0.056	12.000 +/-0.130			BP01600-02200-01200-BSO	Bushes - Bronze - Sintered - Unflanged - Oilite
16.000 +0.006/+0.024	22.000 +0.035/+0.056	12.000 +/-0.130	28.00	3.00	BF01600-02200-01200-BSO	Bushes - Bronze - Sintered - Flanged - Oilite
16.000 +0.006/+0.024	22.000 +0.035/+0.056	16.000 +/-0.130			BP01600-02200-01600-BSO	Bushes - Bronze - Sintered - Unflanged - Oilite

 Stocked or Short Delivery

 Usually Available

 Long delivery or not in current production

ID	OD	B	DF	bf	Part Number	Type
16.000 x 22.000 mm (0.630 x 0.866 in.)						
16.000 +0.006/+0.024	22.000 +0.035/+0.056	16.000 +/-0.130	28.00	3.00	BF01600-02200-01600-BSO	Bushes - Bronze - Sintered - Flanged - Oilite
16.000 +0.006/+0.024	22.000 +0.035/+0.056	20.000 +/-0.160	28.00	3.00	BF01600-02200-02000-BSO	Bushes - Bronze - Sintered - Flanged - Oilite
16.000 +0.006/+0.024	22.000 +0.035/+0.056	25.000 +/-0.160			BP01600-02200-02500-BSO	Bushes - Bronze - Sintered - Unflanged - Oilite
16.000 +0.006/+0.024	22.000 +0.035/+0.056	25.000 +/-0.160	28.00	3.00	BF01600-02200-02500-BSO	Bushes - Bronze - Sintered - Flanged - Oilite
16.000 +0.006/+0.024	22.000 +0.035/+0.056	30.000 +/-0.160			BP01600-02200-03000-BSO	Bushes - Bronze - Sintered - Unflanged - Oilite
16.000 x 24.000 mm (0.630 x 0.945 in.)						
16.000 +/-0.0254	24.000 +0.0508/+0.0762	30.000 +/-0.127			BP01600-02400-03000-BLG	Bushes - Bronze - Solid - Leaded Gunmetal
16.000 +/-0.0254	24.000 +0.0508/+0.0762	50.000 +/-0.127			BP01600-02400-05000-BLG	Bushes - Bronze - Solid - Leaded Gunmetal
16.000 +/-0.0254	24.000 +0.0508/+0.0762	60.000 +/-0.127			BP01600-02400-06000-BLG	Bushes - Bronze - Solid - Leaded Gunmetal
16.000 +/-0.0254	24.000 +0.0508/+0.0762	80.000 +/-0.127			BP01600-02400-08000-BLG	Bushes - Bronze - Solid - Leaded Gunmetal
17.000 x 19.000 mm (0.669 x 0.748 in.)						
17.000 -0.000/-0.034	19.000 +0.075/-0.000	10.000 +0.00/-0.30			BP01700-01900-01000-DP4	Bushes - Steel - DP4 - Split - Unflanged
17.000 -0.000/-0.034	19.000 +0.075/-0.000	10.000 +0.00/-0.30			BP01700-01900-01000-DU	Bushes - Steel - DU - Split - Unflanged
17.000 -0.000/-0.034	19.000 +0.075/-0.000	10.000 +0.00/-0.30			BP01700-01900-01000-SS6	Bushes - Stainless Steel and PTFE - Unflanged
17.000 -0.000/-0.034	19.000 +0.075/-0.000	12.000 +0.00/-0.30			BP01700-01900-01200-DP4	Bushes - Steel - DP4 - Split - Unflanged
17.000 -0.000/-0.034	19.000 +0.075/-0.000	12.000 +0.00/-0.30			BP01700-01900-01200-DU	Bushes - Steel - DU - Split - Unflanged
17.000 -0.000/-0.034	19.000 +0.075/-0.000	12.000 +0.00/-0.30			BP01700-01900-01200-SS6	Bushes - Stainless Steel and PTFE - Unflanged
17.000 -0.000/-0.034	19.000 +0.075/-0.000	20.000 +0.00/-0.30			BP01700-01900-02000-SS6	Bushes - Stainless Steel and PTFE - Unflanged
17.000 -0.000/-0.018	19.000 +0.021/-0.000	20.000 +0.25/-0.25			BP01700-01900-02000-DP4	Bushes - Steel - DP4 - Split - Unflanged
17.000 -0.000/-0.034	19.000 +0.075/-0.000	20.000 +0.00/-0.30			BP01700-01900-02000-DU	Bushes - Steel - DU - Split - Unflanged
17.463 x 19.844 mm (0.688 x 0.781 in.)						
17.463 -0.025/-0.051	19.844 +0.011/-0.009	22.225 +0.00/-0.30			BP01746-01984-02223-DU	Bushes - Steel - DU - Split - Unflanged
17.463 -0.025/-0.051	19.844 +0.011/-0.009	22.225 +0.25/-0.25			BP01746-01984-02223-SS6	Bushes - Stainless Steel and PTFE - Unflanged
17.463 -0.025/-0.051	19.844 +0.011/-0.009	22.225 +0.00/-0.30			BP01746-01984-02223-DP4	Bushes - Steel - DP4 - Split - Unflanged
17.463 x 20.638 mm (0.688 x 0.813 in.)						
17.463 +0/+0.025	20.638 +0.039/+0.064	25.400 +/-0.127			BP01746-02064-02540-BS	Bushes - Bronze - Sintered - Unflanged
17.463 +/-0.0254	20.638 +0.0508/+0.0762	25.400 +/-0.127			BP01746-02064-02540-BLG	Bushes - Bronze - Solid - Leaded Gunmetal
17.463 +/-0.0254	20.638 +0.0508/+0.0762	38.100 +/-0.127			BP01746-02064-03810-BLG	Bushes - Bronze - Solid - Leaded Gunmetal
17.463 +/-0.0254	20.638 +0.0508/+0.0762	50.800 +/-0.127			BP01746-02064-05080-BLG	Bushes - Bronze - Solid - Leaded Gunmetal
17.463 x 22.225 mm (0.688 x 0.875 in.)						
17.463 +0.025/+0.050	22.225 +0.051/+0.076	19.050 +/-0.127			BP01746-02223-01905-BS	Bushes - Bronze - Sintered - Unflanged
17.463 +0.025/+0.050	22.225 +0.051/+0.076	25.400 +/-0.127			BP01746-02223-02540-BS	Bushes - Bronze - Sintered - Unflanged
17.463 +/-0.0254	22.225 +0.0508/+0.0762	25.400 +/-0.127			BP01746-02223-02540-BLG	Bushes - Bronze - Solid - Leaded Gunmetal
17.463 +0.025/+0.050	22.225 +0.051/+0.076	31.750 +/-0.127			BP01746-02223-03175-BS	Bushes - Bronze - Sintered - Unflanged
17.463 +0.025/+0.050	22.225 +0.051/+0.076	38.100 +/-0.127			BP01746-02223-03810-BS	Bushes - Bronze - Sintered - Unflanged
17.463 +0.025/+0.050	22.225 +0.051/+0.076	44.450 +/-0.190			BP01746-02223-04445-BS	Bushes - Bronze - Sintered - Unflanged
17.463 +0.025/+0.050	22.225 +0.051/+0.076	50.800 +/-0.190			BP01746-02223-05080-BS	Bushes - Bronze - Sintered - Unflanged
17.463 +/-0.0254	22.225 +0.0508/+0.0762	50.800 +/-0.127			BP01746-02223-05080-BLG	Bushes - Bronze - Solid - Leaded Gunmetal

 Stocked or Short Delivery

 Usually Available

 Long delivery or not in current production

ID	OD	B	DF	bf	Part Number	Type
17.463 x 23.813 mm (0.688 x 0.938 in.)						
17.463 +/-0.0254	23.813 +0.0508/+0.0762	25.400 +/-0.127			BP01746-02381-02540-BLG	Bushes - Bronze - Solid - Leaded Gunmetal
17.463 +/-0.0254	23.813 +0.0508/+0.0762	38.100 +/-0.127			BP01746-02381-03810-BLG	Bushes - Bronze - Solid - Leaded Gunmetal
17.463 +/-0.0254	23.813 +0.0508/+0.0762	50.800 +/-0.127			BP01746-02381-05080-BLG	Bushes - Bronze - Solid - Leaded Gunmetal
17.463 x 25.400 mm (0.688 x 1.000 in.)						
17.463 +/-0.0254	25.400 +0.0508/+0.0762	50.800 +/-0.127			BP01746-02540-05080-BLG	Bushes - Bronze - Solid - Leaded Gunmetal
18.000 x 20.000 mm (0.709 x 0.787 in.)						
18.000 -0.000/-0.034	20.000 +0.075/-0.000	10.000 +0.00/-0.30			BP01800-02000-01000-SS6	Bushes - Stainless Steel and PTFE - Unflanged
18.000 -0.000/-0.034	20.000 +0.075/-0.000	10.000 +0.00/-0.30			BP01800-02000-01000-DU	Bushes - Steel - DU - Split - Unflanged
18.000 -0.000/-0.034	20.000 +0.021/-0.000	10.000 +0.25/-0.25			BP01800-02000-01000-DP4	Bushes - Steel - DP4 - Split - Unflanged
18.000 -0.000/-0.034	20.000 +0.075/-0.000	12.000 +0.00/-0.30			BP01800-02000-01200-DP4	Bushes - Steel - DP4 - Split - Unflanged
18.000 -0.000/-0.034	20.000 +0.075/-0.000	12.000 +0.00/-0.30			BP01800-02000-01200-DU	Bushes - Steel - DU - Split - Unflanged
18.000 -0.000/-0.034	20.000 +0.075/-0.000	12.000 +0.00/-0.30			BP01800-02000-01200-SS6	Bushes - Stainless Steel and PTFE - Unflanged
18.000 -0.000/-0.034	20.000 +0.075/-0.000	12.000 +0.25/-0.25	26.00	0.80	BF01800-02000-01200-DUB	Bushes - Steel - DUB - Split - Flanged
18.000 -0.000/-0.018	20.000 +0.021/-0.000	12.000 +0.25/-0.25	26.00	1.00	BF01800-02000-01200-DP4	Bushes - Steel - DP4 - Split - Flanged
18.000 -0.000/-0.034	20.000 +0.075/-0.000	12.000 +0.25/-0.25	26.00	1.00	BF01800-02000-01200-DU	Bushes - Steel - DU - Split - Flanged
18.000 -0.000/-0.034	20.000 +0.075/-0.000	12.000 +0.25/-0.25	26.00	1.00	BF01800-02000-01200-SS6	Bushes - Stainless Steel and PTFE - Flanged
18.000 -0.000/-0.034	20.000 +0.075/-0.000	15.000 +0.00/-0.30			BP01800-02000-01500-DU	Bushes - Steel - DU - Split - Unflanged
18.000 -0.000/-0.034	20.000 +0.075/-0.000	15.000 +0.00/-0.30			BP01800-02000-01500-SS6	Bushes - Stainless Steel and PTFE - Unflanged
18.000 -0.000/-0.018	20.000 +0.021/-0.000	15.000 +0.25/-0.25			BP01800-02000-01500-DP4	Bushes - Steel - DP4 - Split - Unflanged
18.000 -0.000/-0.034	20.000 +0.075/-0.000	15.000 +0.25/-0.25			BP01800-02000-01500-DX	Bushes - Steel - DX - Split - Unflanged
18.000 -0.000/-0.034	20.000 +0.075/-0.000	17.000 +0.25/-0.25	26.00	1.00	BF01800-02000-01700-DU	Bushes - Steel - DU - Split - Flanged
18.000 -0.000/-0.034	20.000 +0.075/-0.000	17.000 +0.25/-0.25	26.00	1.00	BF01800-02000-01700-SS6	Bushes - Stainless Steel and PTFE - Flanged
18.000 -0.000/-0.018	20.000 +0.021/-0.000	17.000 +0.25/-0.25	26.00	1.00	BF01800-02000-01700-DP4	Bushes - Steel - DP4 - Split - Flanged
18.000 -0.000/-0.034	20.000 +0.075/-0.000	20.000 +0.00/-0.30			BP01800-02000-02000-SS6	Bushes - Stainless Steel and PTFE - Unflanged
18.000 -0.000/-0.018	20.000 +0.021/-0.000	20.000 +0.25/-0.25			BP01800-02000-02000-DP4	Bushes - Steel - DP4 - Split - Unflanged
18.000 -0.000/-0.034	20.000 +0.075/-0.000	20.000 +0.00/-0.30			BP01800-02000-02000-DU	Bushes - Steel - DU - Split - Unflanged
18.000 -0.000/-0.034	20.000 +0.075/-0.000	20.000 +0.25/-0.25			BP01800-02000-02000-DUB	Bushes - Steel - DUB - Split - Unflanged
18.000 -0.000/-0.034	20.000 +0.075/-0.000	20.000 +0.25/-0.25			BP01800-02000-02000-DX	Bushes - Steel - DX - Split - Unflanged
18.000 -0.000/-0.034	20.000 +0.075/-0.000	20.000 +0.25/-0.25	26.00	1.00	BF01800-02000-02000-DU	Bushes - Steel - DU - Split - Flanged
18.000 -0.000/-0.034	20.000 +0.075/-0.000	20.000 +0.25/-0.25	26.00	1.00	BF01800-02000-02000-SS6	Bushes - Stainless Steel and PTFE - Flanged
18.000 -0.000/-0.034	20.000 +0.021/-0.000	20.000 +0.25/-0.25	26.00	1.00	BF01800-02000-02000-DP4	Bushes - Steel - DP4 - Split - Flanged
18.000 -0.000/-0.034	20.000 +0.075/-0.000	22.000 +0.25/-0.25	26.00	0.80	BF01800-02000-02200-DUB	Bushes - Steel - DUB - Split - Flanged
18.000 -0.000/-0.034	20.000 +0.075/-0.000	22.000 +0.25/-0.25	26.00	1.00	BF01800-02000-02200-DU	Bushes - Steel - DU - Split - Flanged
18.000 -0.000/-0.018	20.000 +0.021/-0.000	22.000 +0.25/-0.25	26.00	1.00	BF01800-02000-02200-DP4	Bushes - Steel - DP4 - Split - Flanged
18.000 -0.000/-0.018	20.000 +0.021/-0.000	25.000 +0.25/-0.25			BP01800-02000-02500-DP4	Bushes - Steel - DP4 - Split - Unflanged
18.000 -0.000/-0.034	20.000 +0.075/-0.000	25.000 +0.00/-0.30			BP01800-02000-02500-DU	Bushes - Steel - DU - Split - Unflanged
18.000 -0.000/-0.034	20.000 +0.075/-0.000	25.000 +0.00/-0.30			BP01800-02000-02500-SS6	Bushes - Stainless Steel and PTFE - Unflanged
18.000 -0.000/-0.034	20.000 +0.075/-0.000	25.000 +0.25/-0.25			BP01800-02000-02500-DUB	Bushes - Steel - DUB - Split - Unflanged
18.000 -0.000/-0.034	20.000 +0.075/-0.000	25.000 +0.25/-0.25			BP01800-02000-02500-DX	Bushes - Steel - DX - Split - Unflanged

Stocked or Short Delivery

Usually Available

Long delivery or not in current production

ID	OD	B	DF	bf	Part Number	Type
18.000 x 22.000 mm (0.709 x 0.866 in.)						
18.000 +0.006/+0.024	22.000 +0.035/+0.056	12.000 +/-0.130			BP01800-02200-01200-BSO	Bushes - Bronze - Sintered - Unflanged - Oilite
18.000 +0.006/+0.024	22.000 +0.035/+0.056	18.000 +/-0.130			BP01800-02200-01800-BSO	Bushes - Bronze - Sintered - Unflanged - Oilite
18.000 +0.006/+0.024	22.000 +0.035/+0.056	30.000 +/-0.160			BP01800-02200-03000-BSO	Bushes - Bronze - Sintered - Unflanged - Oilite
18.000 x 24.000 mm (0.709 x 0.945 in.)						
18.000 +0.006/+0.024	24.000 +0.035/+0.056	12.000 +/-0.130	30.00	3.00	BF01800-02400-01200-BSO	Bushes - Bronze - Sintered - Flanged - Oilite
18.000 +0.006/+0.024	24.000 +0.035/+0.056	18.000 +/-0.130			BP01800-02400-01800-BSO	Bushes - Bronze - Sintered - Unflanged - Oilite
18.000 +0.006/+0.024	24.000 +0.035/+0.056	18.000 +/-0.130	30.00	3.00	BF01800-02400-01800-BSO	Bushes - Bronze - Sintered - Flanged - Oilite
18.000 +0.006/+0.024	24.000 +0.035/+0.056	22.000 +/-0.160	30.00	3.00	BF01800-02400-02200-BSO	Bushes - Bronze - Sintered - Flanged - Oilite
18.000 +0.006/+0.024	24.000 +0.035/+0.056	30.000 +/-0.160			BP01800-02400-03000-BSO	Bushes - Bronze - Sintered - Unflanged - Oilite
18.000 +0.006/+0.024	24.000 +0.035/+0.056	30.000 +/-0.160	30.00	3.00	BF01800-02400-03000-BSO	Bushes - Bronze - Sintered - Flanged - Oilite
19.050 x 20.638 mm (0.750 x 0.813 in.)						
19.050 +/-0.0254	20.638 +0.0508/+0.0762	38.100 +/-0.127			BP01905-02064-03810-BLG	Bushes - Bronze - Solid - Leaded Gunmetal
19.050 x 22.225 mm (0.750 x 0.875 in.)						
19.050 -0.025/-0.053	22.225 +0.013/-0.008	6.350 +0.00/-0.30			BP01905-02223-00635-DP4	Bushes - Steel - DP4 - Split - Unflanged
19.050 -0.025/-0.053	22.225 +0.013/-0.008	6.350 +0.00/-0.30			BP01905-02223-00635-DU	Bushes - Steel - DU - Split - Unflanged
19.050 -0.025/-0.053	22.225 +0.013/-0.008	6.350 +0.25/-0.25			BP01905-02223-00635-SS6	Bushes - Stainless Steel and PTFE - Unflanged
19.050 -0.025/-0.053	22.225 +0.013/-0.008	9.525 +0.25/-0.25			BP01905-02223-00953-SS6	Bushes - Stainless Steel and PTFE - Unflanged
19.050 -0.025/-0.053	22.225 +0.013/-0.008	9.525 +0.00/-0.30			BP01905-02223-00953-DU	Bushes - Steel - DU - Split - Unflanged
19.050 -0.025/-0.053	22.225 +0.013/-0.008	9.525 +0.00/-0.30			BP01905-02223-00953-DP4	Bushes - Steel - DP4 - Split - Unflanged
19.050 -0.025/-0.053	22.225 +0.013/-0.007	9.525 +0.25/-0.25	29.08	1.73	BF01905-02223-00953-DP4	Bushes - Steel - DP4 - Split - Flanged
19.050 -0.025/-0.053	22.225 +0.013/-0.007	9.525 +0.25/-0.25	29.08	1.73	BF01905-02223-00953-SS6	Bushes - Stainless Steel and PTFE - Flanged
19.050 -0.025/-0.053	22.225 +0.013/-0.007	9.525 +0.25/-0.25	29.08	1.73	BF01905-02223-00953-DU	Bushes - Steel - DU - Split - Flanged
19.050 +0.0254/+0.0508	22.225 +0.0508/+0.0762	12.700 +0.127/-0.127			BP01905-02223-01270-BS	Bushes - Bronze - Sintered - Unflanged
19.050 -0.025/-0.053	22.225 +0.013/-0.008	12.700 +0.00/-0.30			BP01905-02223-01270-DU	Bushes - Steel - DU - Split - Unflanged
19.050 -0.025/-0.053	22.225 +0.013/-0.008	12.700 +0.25/-0.25			BP01905-02223-01270-SS6	Bushes - Stainless Steel and PTFE - Unflanged
19.050 +0.007/+0.028	22.225 +0.035/+0.056	12.700 +/-0.130			BP01905-02223-01270-BSO	Bushes - Bronze - Sintered - Unflanged - Oilite
19.050 +0.0254/+0.0508	22.225 +0.0508/+0.0762	12.700 +0.127/-0.127			BP01905-02223-01270-BFG	Bushes - Bronze - Sintered - ECO841 Food Grade - Unflanged
19.050 -0.025/-0.053	22.225 +0.013/-0.008	12.700 +0.00/-0.30			BP01905-02223-01270-DP4	Bushes - Steel - DP4 - Split - Unflanged
19.050 -0.025/-0.053	22.225 +0.013/-0.007	12.700 +0.25/-0.25	29.08	1.73	BF01905-02223-01270-SS6	Bushes - Stainless Steel and PTFE - Flanged
19.050 -0.025/-0.053	22.225 +0.013/-0.007	12.700 +0.25/-0.25	29.08	1.73	BF01905-02223-01270-DU	Bushes - Steel - DU - Split - Flanged
19.050 -0.025/-0.053	22.225 +0.013/-0.007	12.700 +0.25/-0.25	29.08	1.73	BF01905-02223-01270-DP4	Bushes - Steel - DP4 - Split - Flanged
19.050 +0.0254/+0.0508	22.225 +0.0508/+0.0762	15.875 +0.127/-0.127			BP01905-02223-01588-BS	Bushes - Bronze - Sintered - Unflanged
19.050 +0.0254/+0.0508	22.225 +0.0508/+0.0762	15.875 +0.127/-0.127			BP01905-02223-01588-BFG	Bushes - Bronze - Sintered - ECO841 Food Grade - Unflanged
19.050 +0.007/+0.028	22.225 +0.035/+0.056	15.875 +/-0.130			BP01905-02223-01588-BSO	Bushes - Bronze - Sintered - Unflanged - Oilite
19.050 -0.025/-0.053	22.225 +0.013/-0.008	15.875 +0.00/-0.30			BP01905-02223-01588-DP4	Bushes - Steel - DP4 - Split - Unflanged
19.050 -0.025/-0.053	22.225 +0.013/-0.008	15.875 +0.00/-0.30			BP01905-02223-01588-DU	Bushes - Steel - DU - Split - Unflanged
19.050 -0.025/-0.053	22.225 +0.013/-0.008	15.875 +0.25/-0.25			BP01905-02223-01588-SS6	Bushes - Stainless Steel and PTFE - Unflanged
19.050 +0.007/+0.028	22.225 +0.035/+0.056	19.050 +/-0.160			BP01905-02223-01905-BSO	Bushes - Bronze - Sintered - Unflanged - Oilite
19.050 +0.0254/+0.0508	22.225 +0.0508/+0.0762	19.050 +0.127/-0.127			BP01905-02223-01905-BS	Bushes - Bronze - Sintered - Unflanged

 Stocked or Short Delivery

 Usually Available

 Long delivery or not in current production

ID	OD	B	DF	bf	Part Number	Type
19.050 x 22.225 mm (0.750 x 0.875 in.)						
19.050 -0.025/-0.053	22.225 +0.013/-0.008	19.050 +0.00/-0.30			BP01905-02223-01905-DU	Bushes - Steel - DU - Split - Unflanged
19.050 +0.0254/+0.0508	22.225 +0.0508/+0.0762	19.050 +0.127/-0.127			BP01905-02223-01905-BFG	Bushes - Bronze - Sintered - ECO841 Food Grade - Unflanged
19.050 -0.025/-0.053	22.225 +0.013/-0.008	19.050 +0.25/-0.25			BP01905-02223-01905-SS6	Bushes - Stainless Steel and PTFE - Unflanged
19.050 -0.025/-0.053	22.225 +0.013/-0.008	19.050 +0.00/-0.30			BP01905-02223-01905-DP4	Bushes - Steel - DP4 - Split - Unflanged
19.050 +/-0.0254	22.225 +0.0508/+0.0762	19.050 +/-0.127			BP01905-02223-01905-BC9	Bushes - Bronze - Solid - Leaded Gunmetal
19.050 +/-0.0254	22.225 +0.0508/+0.0762	19.050 +/-0.127			BP01905-02223-01905-BLG	Bushes - Bronze - Solid - Leaded Gunmetal
19.050 +0.025/+0.050	22.225 +0.051/+0.076	19.050 +/-0.127	28.58	3.97	BF01905-02223-01905-BS	Bushes - Bronze - Sintered - Flanged
19.050 -0.025/-0.053	22.225 +0.013/-0.007	19.050 +0.25/-0.25	29.08	1.73	BF01905-02223-01905-SS6	Bushes - Stainless Steel and PTFE - Flanged
19.050 -0.025/-0.053	22.225 +0.013/-0.007	19.050 +0.25/-0.25	29.08	1.73	BF01905-02223-01905-DU	Bushes - Steel - DU - Split - Flanged
19.050 -0.025/-0.053	22.225 +0.013/-0.007	19.050 +0.25/-0.25	29.08	1.73	BF01905-02223-01905-DP4	Bushes - Steel - DP4 - Split - Flanged
19.050 +0.025/+0.050	22.225 +0.051/+0.076	22.225 +/-0.127			BP01905-02223-02223-BS	Bushes - Bronze - Sintered - Unflanged
19.050 +0.007/+0.028	22.225 +0.035/+0.056	25.400 +/-0.160			BP01905-02223-02540-BSO	Bushes - Bronze - Sintered - Unflanged - Oilite
19.050 -0.025/-0.053	22.225 +0.013/-0.008	25.400 +0.00/-0.30			BP01905-02223-02540-DU	Bushes - Steel - DU - Split - Unflanged
19.050 +0.0254/+0.0508	22.225 +0.0508/+0.0762	25.400 +0.127/-0.127			BP01905-02223-02540-BS	Bushes - Bronze - Sintered - Unflanged
19.050 -0.025/-0.053	22.225 +0.013/-0.008	25.400 +0.25/-0.25			BP01905-02223-02540-SS6	Bushes - Stainless Steel and PTFE - Unflanged
19.050 -0.025/-0.053	22.225 +0.013/-0.008	25.400 +0.00/-0.30			BP01905-02223-02540-DP4	Bushes - Steel - DP4 - Split - Unflanged
19.050 +0.0254/+0.0508	22.225 +0.0508/+0.0762	25.400 +0.127/-0.127			BP01905-02223-02540-BFG	Bushes - Bronze - Sintered - ECO841 Food Grade - Unflanged
19.050 +/-0.0254	22.225 +0.0508/+0.0762	25.400 +/-0.127			BP01905-02223-02540-BC9	Bushes - Bronze - Solid - Leaded Gunmetal
19.050 +/-0.0254	22.225 +0.0508/+0.0762	25.400 +/-0.127			BP01905-02223-02540-BLG	Bushes - Bronze - Solid - Leaded Gunmetal
19.050 +0.025/+0.050	22.225 +0.051/+0.076	25.400 +/-0.127	28.58	3.97	BF01905-02223-02540-BS	Bushes - Bronze - Sintered - Flanged
19.050 -0.025/-0.053	22.225 +0.013/-0.007	25.400 +0.25/-0.25	29.08	1.73	BF01905-02223-02540-SS6	Bushes - Stainless Steel and PTFE - Flanged
19.050 -0.025/-0.053	22.225 +0.013/-0.007	25.400 +0.25/-0.25	29.08	1.73	BF01905-02223-02540-DP4	Bushes - Steel - DP4 - Split - Flanged
19.050 -0.025/-0.053	22.225 +0.013/-0.007	25.400 +0.25/-0.25	29.08	1.73	BF01905-02223-02540-DU	Bushes - Steel - DU - Split - Flanged
19.050 +0.025/+0.050	22.225 +0.051/+0.076	28.575 +/-0.127			BP01905-02223-02858-BS	Bushes - Bronze - Sintered - Unflanged
19.050 +0.0254/+0.0508	22.225 +0.0508/+0.0762	31.750 +0.127/-0.127			BP01905-02223-03175-BS	Bushes - Bronze - Sintered - Unflanged
19.050 +0.0254/+0.0508	22.225 +0.0508/+0.0762	31.750 +0.127/-0.127			BP01905-02223-03175-BFG	Bushes - Bronze - Sintered - ECO841 Food Grade - Unflanged
19.050 +0.007/+0.028	22.225 +0.035/+0.056	31.750 +/-0.190			BP01905-02223-03175-BSO	Bushes - Bronze - Sintered - Unflanged - Oilite
19.050 +/-0.0254	22.225 +0.0508/+0.0762	31.750 +/-0.127			BP01905-02223-03175-BC9	Bushes - Bronze - Solid - Leaded Gunmetal
19.050 +/-0.0254	22.225 +0.0508/+0.0762	31.750 +/-0.127			BP01905-02223-03175-BLG	Bushes - Bronze - Solid - Leaded Gunmetal
19.050 +0.025/+0.050	22.225 +0.051/+0.076	38.100 +/-0.127			BP01905-02223-03810-BS	Bushes - Bronze - Sintered - Unflanged
19.050 +/-0.0254	22.225 +0.0508/+0.0762	38.100 +/-0.127			BP01905-02223-03810-BC9	Bushes - Bronze - Solid - Leaded Gunmetal
19.050 +/-0.0254	22.225 +0.0508/+0.0762	38.100 +/-0.127			BP01905-02223-03810-BLG	Bushes - Bronze - Solid - Leaded Gunmetal
19.050 +0.025/+0.050	22.225 +0.051/+0.076	41.275 +/-0.190			BP01905-02223-04128-BS	Bushes - Bronze - Sintered - Unflanged
19.050 +/-0.0254	22.225 +0.0508/+0.0762	50.800 +/-0.127			BP01905-02223-05080-BLG	Bushes - Bronze - Solid - Leaded Gunmetal
19.050 +/-0.0254	22.225 +0.0508/+0.0762	63.500 +/-0.127			BP01905-02223-06350-BLG	Bushes - Bronze - Solid - Leaded Gunmetal
19.050 x 23.813 mm (0.750 x 0.938 in.)						
19.050 +0.025/+0.050	23.813 +0.063/+0.088	12.700 +/-0.127			BP01905-02381-01270-BS	Bushes - Bronze - Sintered - Unflanged
19.050 +0.025/+0.050	23.813 +0.063/+0.088	15.875 +/-0.127			BP01905-02381-01588-BS	Bushes - Bronze - Sintered - Unflanged
19.050 +0.025/+0.050	23.813 +0.063/+0.088	19.050 +/-0.127			BP01905-02381-01905-BS	Bushes - Bronze - Sintered - Unflanged

 Stocked or Short Delivery

 Usually Available

 Long delivery or not in current production

ID	OD	B	DF	bf	Part Number	Type
19.050 x 23.813 mm (0.750 x 0.938 in.)						
19.050 +0.025/+0.050	23.813 +0.063/+0.088	22.225 +/-0.127			BP01905-02381-02223-BS	Bushes - Bronze - Sintered - Unflanged
19.050 +0.025/+0.050	23.813 +0.063/+0.088	25.400 +/-0.127			BP01905-02381-02540-BS	Bushes - Bronze - Sintered - Unflanged
19.050 +/-0.0254	23.813 +0.0508/+0.0762	25.400 +/-0.127			BP01905-02381-02540-BLG	Bushes - Bronze - Solid - Leaded Gunmetal
19.050 +0.025/+0.050	23.813 +0.039/+0.064	25.400 +/-0.127	30.16	3.97	BF01905-02381-02540-BS	Bushes - Bronze - Sintered - Flanged
19.050 +0.025/+0.050	23.813 +0.063/+0.088	28.575 +/-0.127			BP01905-02381-02858-BS	Bushes - Bronze - Sintered - Unflanged
19.050 +0.025/+0.050	23.813 +0.063/+0.088	31.750 +/-0.127			BP01905-02381-03175-BS	Bushes - Bronze - Sintered - Unflanged
19.050 +0.013/+0.038	23.813 +0.039/+0.064	38.100 +/-0.127			BP01905-02381-03810-BS04	Bushes - Bronze - Sintered - Unflanged
19.050 +0.025/+0.050	23.813 +0.063/+0.088	38.100 +/-0.127			BP01905-02381-03810-BS05	Bushes - Bronze - Sintered - Unflanged
19.050 +/-0.0254	23.813 +0.0508/+0.0762	38.100 +/-0.127			BP01905-02381-03810-BLG	Bushes - Bronze - Solid - Leaded Gunmetal
19.050 +0.025/+0.050	23.813 +0.039/+0.064	38.100 +/-0.127	30.16	3.97	BF01905-02381-03810-BS	Bushes - Bronze - Sintered - Flanged
19.050 +0.025/+0.050	23.813 +0.063/+0.088	41.275 +/-0.190			BP01905-02381-04128-BS	Bushes - Bronze - Sintered - Unflanged
19.050 +0.025/+0.050	23.813 +0.063/+0.088	44.450 +/-0.190			BP01905-02381-04445-BS	Bushes - Bronze - Sintered - Unflanged
19.050 +0.025/+0.050	23.813 +0.063/+0.088	47.625 +/-0.190			BP01905-02381-04763-BS	Bushes - Bronze - Sintered - Unflanged
19.050 +0.025/+0.050	23.813 +0.063/+0.088	50.800 +/-0.190			BP01905-02381-05080-BS	Bushes - Bronze - Sintered - Unflanged
19.050 +/-0.0254	23.813 +0.0508/+0.0762	50.800 +/-0.127			BP01905-02381-05080-BLG	Bushes - Bronze - Solid - Leaded Gunmetal
19.050 +/-0.0254	23.813 +0.0508/+0.0762	57.150 +/-0.127			BP01905-02381-05715-BLG	Bushes - Bronze - Solid - Leaded Gunmetal
19.050 +/-0.0254	23.813 +0.0508/+0.0762	63.500 +/-0.127			BP01905-02381-06350-BLG	Bushes - Bronze - Solid - Leaded Gunmetal

19.050 x 25.400 mm (0.750 x 1.000 in.)						
19.050 +0.0254/+0.0508	25.400 +0.0508/+0.0762	12.700 +0.127/-0.127			BP01905-02540-01270-BS	Bushes - Bronze - Sintered - Unflanged
19.050 +0.0254/+0.0508	25.400 +0.0508/+0.0762	12.700 +0.127/-0.127			BP01905-02540-01270-BFG	Bushes - Bronze - Sintered - ECO841 Food Grade - Unflanged
19.050 +0.0254/+0.0508	25.400 +0.0508/+0.0762	15.875 +0.127/-0.127			BP01905-02540-01588-BS	Bushes - Bronze - Sintered - Unflanged
19.050 +0.0254/+0.0508	25.400 +0.0508/+0.0762	15.875 +0.127/-0.127			BP01905-02540-01588-BFG	Bushes - Bronze - Sintered - ECO841 Food Grade - Unflanged
19.050 +0.007/+0.028	25.400 +0.035/+0.056	15.875 +/-0.130			BP01905-02540-01588-BSO	Bushes - Bronze - Sintered - Unflanged - Oilite
19.050 +0.025/+0.050	25.400 +0.051/+0.076	15.875 +/-0.127	31.75	3.97	BF01905-02540-01588-BS	Bushes - Bronze - Sintered - Flanged
19.050 +0.025/+0.051	25.400 +0.025/+0.051	15.875 +/-0.127	31.75	4.76	BF01905-02540-01588-BDP	Bushes - Bronze - Dri-Plane - Flanged
19.050 +0.0254/+0.0508	25.400 +0.0508/+0.0762	19.050 +0.127/-0.127			BP01905-02540-01905-BS	Bushes - Bronze - Sintered - Unflanged
19.050 +0.007/+0.028	25.400 +0.035/+0.056	19.050 +/-0.160			BP01905-02540-01905-BSO	Bushes - Bronze - Sintered - Unflanged - Oilite
19.050 +0.0254/+0.0508	25.400 +0.0508/+0.0762	19.050 +0.127/-0.127			BP01905-02540-01905-BFG	Bushes - Bronze - Sintered - ECO841 Food Grade - Unflanged
19.050 +/-0.0254	25.400 +0.0508/+0.0762	19.050 +/-0.127			BP01905-02540-01905-BC9	Bushes - Bronze - Solid - Leaded Gunmetal
19.050 +/-0.0254	25.400 +0.0508/+0.0762	19.050 +/-0.127			BP01905-02540-01905-BLG	Bushes - Bronze - Solid - Leaded Gunmetal
19.050 +0.025/+0.050	25.400 +0.051/+0.076	19.050 +/-0.127	31.75	3.97	BF01905-02540-01905-BS	Bushes - Bronze - Sintered - Flanged
19.050 +0.007/+0.028	25.400 +0.035/+0.056	19.050 +/-0.160	34.93	3.18	BF01905-02540-01905-BSO	Bushes - Bronze - Sintered - Flanged - Oilite
19.050 +0.025/+0.050	25.400 +0.051/+0.076	22.225 +/-0.127			BP01905-02540-02223-BS	Bushes - Bronze - Sintered - Unflanged
19.050 +0.007/+0.028	25.400 +0.035/+0.056	22.225 +/-0.160			BP01905-02540-02223-BSO	Bushes - Bronze - Sintered - Unflanged - Oilite
19.050 +0.038/+0.063	25.400 +0.025/+0.050	25.400 +0.00/-0.51			BP01905-02540-02540-AF	Bushes - Aluminium - Frelon Lined - Unflanged
19.050 +0.0254/+0.0508	25.400 +0.0508/+0.0762	25.400 +0.127/-0.127			BP01905-02540-02540-BS	Bushes - Bronze - Sintered - Unflanged
19.050 +0.0254/+0.0508	25.400 +0.0508/+0.0762	25.400 +0.127/-0.127			BP01905-02540-02540-BFG	Bushes - Bronze - Sintered - ECO841 Food Grade - Unflanged
19.050 +0.007/+0.028	25.400 +0.035/+0.056	25.400 +/-0.160			BP01905-02540-02540-BSO	Bushes - Bronze - Sintered - Unflanged - Oilite
19.050 +/-0.0254	25.400 +0.0508/+0.0762	25.400 +/-0.127			BP01905-02540-02540-BC9	Bushes - Bronze - Solid - Leaded Gunmetal

 Stocked or Short Delivery

 Usually Available

 Long delivery or not in current production

ID	OD	B	DF	bf	Part Number	Type
19.050 x 25.400 mm (0.750 x 1.000 in.)						
19.050 +/-0.0254	25.400 +0.0508/+0.0762	25.400 +/-0.127			BP01905-02540-02540-BLG	Bushes - Bronze - Solid - Leaded Gunmetal
19.050 +0.038/+0.063	25.400 +0.025/+0.050	25.400 +0.00/-0.51	31.75	3.18	BF01905-02540-02540-AF	Bushes - Aluminium - Frelon Lined - Flanged
19.050 +0.025/+0.050	25.400 +0.051/+0.076	25.400 +/-0.127	31.75	3.97	BF01905-02540-02540-BS	Bushes - Bronze - Sintered - Flanged
19.050 +0.007/+0.028	25.400 +0.035/+0.056	25.400 +/-0.160	34.93	3.18	BF01905-02540-02540-BSO	Bushes - Bronze - Sintered - Flanged - Oilite
19.050 +0.025/+0.050	25.400 +0.051/+0.076	28.575 +/-0.127			BP01905-02540-02858-BS	Bushes - Bronze - Sintered - Unflanged
19.050 +/-0.0254	25.400 +0.0508/+0.0762	28.575 +/-0.127			BP01905-02540-02858-BC9	Bushes - Bronze - Solid - Leaded Gunmetal
19.050 +0.0254/+0.0508	25.400 +0.0508/+0.0762	31.750 +0.127/-0.127			BP01905-02540-03175-BS	Bushes - Bronze - Sintered - Unflanged
19.050 +0.007/+0.028	25.400 +0.035/+0.056	31.750 +/-0.190			BP01905-02540-03175-BSO	Bushes - Bronze - Sintered - Unflanged - Oilite
19.050 +0.0254/+0.0508	25.400 +0.0508/+0.0762	31.750 +0.127/-0.127			BP01905-02540-03175-BFG	Bushes - Bronze - Sintered - ECO841 Food Grade - Unflanged
19.050 +/-0.0254	25.400 +0.0508/+0.0762	31.750 +/-0.127			BP01905-02540-03175-BC9	Bushes - Bronze - Solid - Leaded Gunmetal
19.050 +/-0.0254	25.400 +0.0508/+0.0762	31.750 +/-0.127			BP01905-02540-03175-BLG	Bushes - Bronze - Solid - Leaded Gunmetal
19.050 +0.025/+0.050	25.400 +0.051/+0.076	31.750 +/-0.127	31.75	3.97	BF01905-02540-03175-BS	Bushes - Bronze - Sintered - Flanged
19.050 +0.007/+0.028	25.400 +0.035/+0.056	31.750 +/-0.190	34.93	3.18	BF01905-02540-03175-BSO	Bushes - Bronze - Sintered - Flanged - Oilite
19.050 +0.0254/+0.0508	25.400 +0.0508/+0.0762	38.100 +0.190/-0.190			BP01905-02540-03810-BS	Bushes - Bronze - Sintered - Unflanged
19.050 +0.0254/+0.0508	25.400 +0.0508/+0.0762	38.100 +0.190/-0.190			BP01905-02540-03810-BFG	Bushes - Bronze - Sintered - ECO841 Food Grade - Unflanged
19.050 +/-0.0254	25.400 +0.0508/+0.0762	38.100 +/-0.127			BP01905-02540-03810-BC9	Bushes - Bronze - Solid - Leaded Gunmetal
19.050 +/-0.0254	25.400 +0.0508/+0.0762	38.100 +/-0.127			BP01905-02540-03810-BLG	Bushes - Bronze - Solid - Leaded Gunmetal
19.050 +0.025/+0.050	25.400 +0.051/+0.076	38.100 +/-0.127	31.75	3.97	BF01905-02540-03810-BS	Bushes - Bronze - Sintered - Flanged
19.050 +0.0254/+0.0508	25.400 +0.0508/+0.0762	44.450 +0.190/-0.190			BP01905-02540-04445-BS	Bushes - Bronze - Sintered - Unflanged
19.050 +0.0254/+0.0508	25.400 +0.0508/+0.0762	44.450 +0.190/-0.190			BP01905-02540-04445-BFG	Bushes - Bronze - Sintered - ECO841 Food Grade - Unflanged
19.050 +/-0.0254	25.400 +0.0508/+0.0762	44.450 +/-0.127			BP01905-02540-04445-BLG	Bushes - Bronze - Solid - Leaded Gunmetal
19.050 +0.025/-0	25.400 +0.025/+0.203	47.625 +/-0.397			BP01905-02540-04763-BS	Bushes - Bronze - Sintered - Unflanged
19.050 +0.025/+0.050	25.400 +0.051/+0.076	50.800 +/-0.190			BP01905-02540-05080-BS	Bushes - Bronze - Sintered - Unflanged
19.050 +/-0.0254	25.400 +0.0508/+0.0762	50.800 +/-0.127			BP01905-02540-05080-BC9	Bushes - Bronze - Solid - Leaded Gunmetal
19.050 +/-0.0254	25.400 +0.0508/+0.0762	50.800 +/-0.127			BP01905-02540-05080-BLG	Bushes - Bronze - Solid - Leaded Gunmetal
19.050 +0.025/+0.050	25.400 +0.051/+0.076	50.800 +/-0.190	31.75	3.97	BF01905-02540-05080-BS	Bushes - Bronze - Sintered - Flanged
19.050 +/-0.0254	25.400 +0.0508/+0.0762	57.150 +/-0.127			BP01905-02540-05715-BC9	Bushes - Bronze - Solid - Leaded Gunmetal
19.050 +/-0.0254	25.400 +0.0508/+0.0762	57.150 +/-0.127			BP01905-02540-05715-BLG	Bushes - Bronze - Solid - Leaded Gunmetal
19.050 +0.0254/+0.0508	25.400 +0.0508/+0.0762	63.500 +0.190/-0.190			BP01905-02540-06350-BS	Bushes - Bronze - Sintered - Unflanged
19.050 +0.0254/+0.0508	25.400 +0.0508/+0.0762	63.500 +0.190/-0.190			BP01905-02540-06350-BFG	Bushes - Bronze - Sintered - ECO841 Food Grade - Unflanged
19.050 +/-0.0254	25.400 +0.0508/+0.0762	63.500 +/-0.127			BP01905-02540-06350-BLG	Bushes - Bronze - Solid - Leaded Gunmetal
19.050 +/-0.0254	25.400 +0.0508/+0.0762	76.200 +/-0.127			BP01905-02540-07620-BLG	Bushes - Bronze - Solid - Leaded Gunmetal
19.050 x 26.988 mm (0.750 x 1.063 in.)						
19.050 +/-0.0254	26.988 +0.0508/+0.0762	50.800 +/-0.127			BP01905-02699-05080-BLG	Bushes - Bronze - Solid - Leaded Gunmetal
19.050 +/-0.0254	26.988 +0.0508/+0.0762	63.500 +/-0.127			BP01905-02699-06350-BLG	Bushes - Bronze - Solid - Leaded Gunmetal
19.050 x 28.575 mm (0.750 x 1.125 in.)						
19.050 +0.025/+0.050	28.575 +0.051/+0.076	12.700 +/-0.127			BP01905-02858-01270-BS	Bushes - Bronze - Sintered - Unflanged
19.050 +0.025/+0.050	28.575 +0.051/+0.076	19.050 +/-0.127			BP01905-02858-01905-BS	Bushes - Bronze - Sintered - Unflanged
19.050 +0.013/-0.000	28.575 +0.013/-0.000	22.225 +0.00/-1.52			BP01905-02858-02223-BAG	Bushes - Aluminium Bronze - Graphite Plug - Unflanged

 Stocked or Short Delivery

 Usually Available

 Long delivery or not in current production

ID	OD	B	DF	bf	Part Number	Type
19.050 x 28.575 mm (0.750 x 1.125 in.)						
19.050 +0.013/-0.000	28.575 +0.013/-0.000	22.225 +0.00/-1.52			BP01905-02858-02223-BA	Bushes - Aluminium Bronze - Unflanged
19.050 +0.013/-0.000	28.575 +0.013/-0.000	22.225 +0.00/-1.52	33.02	4.76	BF01905-02858-02223-BA	Bushes - Aluminium Bronze - Flanged
19.050 +0.013/-0.000	28.575 +0.013/-0.000	22.225 +0.00/-1.52	33.02	4.76	BF01905-02858-02223-BAG	Bushes - Aluminium Bronze - Graphite Plug - Flanged
19.050 +0.0254/+0.0508	28.575 +0.0508/+0.0762	25.400 +0.127/-0.127			BP01905-02858-02540-BS	Bushes - Bronze - Sintered - Unflanged
19.050 +0.0254/+0.0508	28.575 +0.0508/+0.0762	25.400 +0.127/-0.127			BP01905-02858-02540-BFG	Bushes - Bronze - Sintered - ECO841 Food Grade - Unflanged
19.050 +0.025/+0.050	28.575 +0.051/+0.076	31.750 +/-0.127			BP01905-02858-03175-BS	Bushes - Bronze - Sintered - Unflanged
19.050 +0.013/-0.000	28.575 +0.013/-0.000	34.925 +0.00/-1.52			BP01905-02858-03493-BA	Bushes - Aluminium Bronze - Unflanged
19.050 +0.013/-0.000	28.575 +0.013/-0.000	34.925 +0.00/-1.52			BP01905-02858-03493-BAG	Bushes - Aluminium Bronze - Graphite Plug - Unflanged
19.050 +0.013/-0.000	28.575 +0.013/-0.000	34.925 +0.00/-1.52	33.02	4.76	BF01905-02858-03493-BAG	Bushes - Aluminium Bronze - Graphite Plug - Flanged
19.050 +0.013/-0.000	28.575 +0.013/-0.000	34.925 +0.00/-1.52	33.02	4.76	BF01905-02858-03493-BA	Bushes - Aluminium Bronze - Flanged
19.050 +0.025/+0.050	28.575 +0.051/+0.076	38.100 +/-0.127			BP01905-02858-03810-BS	Bushes - Bronze - Sintered - Unflanged
19.050 +0.013/-0.000	28.575 +0.013/-0.000	38.100 +0.00/-1.52			BP01905-02858-03810-BAG	Bushes - Aluminium Bronze - Graphite Plug - Unflanged
19.050 +/-0.0254	28.575 +0.0508/+0.0762	38.100 +/-0.127			BP01905-02858-03810-BC9	Bushes - Bronze - Solid - Leaded Gunmetal
19.050 +/-0.0254	28.575 +0.0508/+0.0762	38.100 +/-0.127			BP01905-02858-03810-BLG	Bushes - Bronze - Solid - Leaded Gunmetal
19.050 +0.025/+0.050	28.575 +0.051/+0.076	44.450 +/-0.190			BP01905-02858-04445-BS	Bushes - Bronze - Sintered - Unflanged
19.050 +0.013/-0.000	28.575 +0.013/-0.000	47.625 +0.00/-1.52	33.02	4.76	BF01905-02858-04763-BAG	Bushes - Aluminium Bronze - Graphite Plug - Flanged
19.050 +0.013/-0.000	28.575 +0.013/-0.000	47.625 +0.00/-1.52	33.02	4.76	BF01905-02858-04763-BA	Bushes - Aluminium Bronze - Flanged
19.050 +0.025/+0.050	28.575 +0.051/+0.076	50.800 +/-0.190			BP01905-02858-05080-BS	Bushes - Bronze - Sintered - Unflanged
19.050 +/-0.0254	28.575 +0.0508/+0.0762	50.800 +/-0.127			BP01905-02858-05080-BLG	Bushes - Bronze - Solid - Leaded Gunmetal
19.050 +0.013/-0.000	28.575 +0.013/-0.000	60.325 +0.00/-1.52	33.02	4.76	BF01905-02858-06033-BA	Bushes - Aluminium Bronze - Flanged
19.050 +0.013/-0.000	28.575 +0.013/-0.000	60.325 +0.00/-1.52	33.02	4.76	BF01905-02858-06033-BAG	Bushes - Aluminium Bronze - Graphite Plug - Flanged
19.050 +/-0.0254	28.575 +0.0508/+0.0762	63.500 +/-0.127			BP01905-02858-06350-BLG	Bushes - Bronze - Solid - Leaded Gunmetal
19.050 +0.013/-0.000	28.575 +0.013/-0.000	73.025 +0.00/-1.52	33.02	4.76	BF01905-02858-07303-BAG	Bushes - Aluminium Bronze - Graphite Plug - Flanged
19.050 +0.013/-0.000	28.575 +0.013/-0.000	73.025 +0.00/-1.52	33.02	4.76	BF01905-02858-07303-BA	Bushes - Aluminium Bronze - Flanged
19.050 +/-0.0254	28.575 +0.0508/+0.0762	76.200 +/-0.127			BP01905-02858-07620-BLG	Bushes - Bronze - Solid - Leaded Gunmetal
19.050 +0.013/-0.000	28.575 +0.013/-0.000	85.725 +0.00/-1.52	33.02	4.76	BF01905-02858-08573-BAG	Bushes - Aluminium Bronze - Graphite Plug - Flanged
19.050 +0.013/-0.000	28.575 +0.013/-0.000	85.725 +0.00/-1.52	33.02	4.76	BF01905-02858-08573-BA	Bushes - Aluminium Bronze - Flanged
19.050 +0.013/-0.000	28.575 +0.013/-0.000	98.425 +0.00/-1.52	33.02	4.76	BF01905-02858-09843-BA	Bushes - Aluminium Bronze - Flanged
19.050 +0.013/-0.000	28.575 +0.013/-0.000	98.425 +0.00/-1.52	33.02	4.76	BF01905-02858-09843-BAG	Bushes - Aluminium Bronze - Graphite Plug - Flanged
19.050 +0.013/-0.000	28.575 +0.013/-0.000	111.125 +0.00/-1.52	33.02	4.76	BF01905-02858-11113-BA	Bushes - Aluminium Bronze - Flanged
19.050 +0.013/-0.000	28.575 +0.013/-0.000	111.125 +0.00/-1.52	33.02	4.76	BF01905-02858-11113-BAG	Bushes - Aluminium Bronze - Graphite Plug - Flanged
19.050 +0.013/-0.000	28.575 +0.013/-0.000	123.825 +0.00/-1.52	33.02	4.76	BF01905-02858-12383-BAG	Bushes - Aluminium Bronze - Graphite Plug - Flanged
19.050 x 31.750 mm (0.750 x 1.250 in.)						
19.050 +0.025/+0.050	31.750 +0.051/+0.076	19.050 +/-0.127			BP01905-03175-01905-BS	Bushes - Bronze - Sintered - Unflanged
19.050 +0.025/+0.050	31.750 +0.051/+0.076	25.400 +/-0.127			BP01905-03175-02540-BS	Bushes - Bronze - Sintered - Unflanged
19.050 +0.025/+0.050	31.750 +0.051/+0.076	31.750 +/-0.127			BP01905-03175-03175-BS	Bushes - Bronze - Sintered - Unflanged
19.050 +0.025/+0.050	31.750 +0.051/+0.076	38.100 +/-0.127			BP01905-03175-03810-BS	Bushes - Bronze - Sintered - Unflanged
19.050 +/-0.0254	31.750 +0.0508/+0.0762	63.500 +/-0.127			BP01905-03175-06350-BLG	Bushes - Bronze - Solid - Leaded Gunmetal
20.000 x 23.000 mm (0.787 x 0.906 in.)						
20.000 -0.000/+0.021	23.000 +0.021/-0.000	10.000 +0.25/-0.25			BP02000-02300-01000-DP4	Bushes - Steel - DP4 - Split - Unflanged

 Stocked or Short Delivery

 Usually Available

 Long delivery or not in current production

ID	OD	B	DF	bf	Part Number	Type
20.000 x 23.000 mm (0.787 x 0.906 in.)						
20.000 -0.000/-0.041	23.000 +0.075/-0.000	10.000 +0.25/-0.25			BP02000-02300-01000-DU	Bushes - Steel - DU - Split - Unflanged
20.000 -0.000/-0.041	23.000 +0.075/-0.000	10.000 +0.25/-0.25			BP02000-02300-01000-DX	Bushes - Steel - DX - Split - Unflanged
20.000 -0.000/-0.041	23.000 +0.075/-0.000	11.500 +0.25/-0.25	30.00	1.40	BF02000-02300-01150-DUB	Bushes - Steel - DUB - Split - Flanged
20.000 -0.000/-0.021	23.000 +0.021/-0.000	11.500 +0.25/-0.25	30.00	1.50	BF02000-02300-01150-DP4	Bushes - Steel - DP4 - Split - Flanged
20.000 -0.000/-0.041	23.000 +0.075/-0.000	11.500 +0.25/-0.25	30.00	1.50	BF02000-02300-01150-DU	Bushes - Steel - DU - Split - Flanged
20.000 -0.000/-0.041	23.000 +0.075/-0.000	11.500 +0.25/-0.25	30.00	1.50	BF02000-02300-01150-SS6	Bushes - Stainless Steel and PTFE - Flanged
20.000 -0.000/-0.041	23.000 +0.075/-0.000	15.000 +0.25/-0.25			BP02000-02300-01500-DU	Bushes - Steel - DU - Split - Unflanged
20.000 -0.000/-0.021	23.000 +0.021/-0.000	15.000 +0.25/-0.25			BP02000-02300-01500-DP4	Bushes - Steel - DP4 - Split - Unflanged
20.000 -0.000/-0.041	23.000 +0.075/-0.000	15.000 +0.25/-0.25			BP02000-02300-01500-DUB	Bushes - Steel - DUB - Split - Unflanged
20.000 -0.000/-0.041	23.000 +0.075/-0.000	15.000 +0.25/-0.25			BP02000-02300-01500-DX	Bushes - Steel - DX - Split - Unflanged
20.000 -0.000/-0.041	23.000 +0.075/-0.000	16.500 +0.25/-0.25	30.00	1.40	BF02000-02300-01650-DUB	Bushes - Steel - DUB - Split - Flanged
20.000 -0.000/-0.041	23.000 +0.075/-0.000	16.500 +0.25/-0.25	30.00	1.50	BF02000-02300-01650-SS6	Bushes - Stainless Steel and PTFE - Flanged
20.000 -0.000/-0.041	23.000 +0.075/-0.000	16.500 +0.25/-0.25	30.00	1.50	BF02000-02300-01650-DU	Bushes - Steel - DU - Split - Flanged
20.000 -0.000/-0.021	23.000 +0.021/-0.000	16.500 +0.25/-0.25	30.00	1.50	BF02000-02300-01650-DP4	Bushes - Steel - DP4 - Split - Flanged
20.000 -0.000/-0.021	23.000 +0.021/-0.000	20.000 +0.25/-0.25			BP02000-02300-02000-DP4	Bushes - Steel - DP4 - Split - Unflanged
20.000 -0.000/-0.041	23.000 +0.075/-0.000	20.000 +0.25/-0.25			BP02000-02300-02000-DU	Bushes - Steel - DU - Split - Unflanged
20.000 -0.000/-0.041	23.000 +0.075/-0.000	20.000 +0.25/-0.25			BP02000-02300-02000-DUB	Bushes - Steel - DUB - Split - Unflanged
20.000 -0.000/-0.041	23.000 +0.075/-0.000	20.000 +0.25/-0.25			BP02000-02300-02000-DX	Bushes - Steel - DX - Split - Unflanged
20.000 -0.000/-0.041	23.000 +0.075/-0.000	21.500 +0.25/-0.25	30.00	1.40	BF02000-02300-02150-DUB	Bushes - Steel - DUB - Split - Flanged
20.000 -0.000/-0.041	23.000 +0.075/-0.000	21.500 +0.25/-0.25	30.00	1.50	BF02000-02300-02150-DU	Bushes - Steel - DU - Split - Flanged
20.000 -0.000/-0.041	23.000 +0.075/-0.000	21.500 +0.25/-0.25	30.00	1.50	BF02000-02300-02150-SS6	Bushes - Stainless Steel and PTFE - Flanged
20.000 -0.000/-0.021	23.000 +0.021/-0.000	21.500 +0.25/-0.25	30.00	1.50	BF02000-02300-02150-DP4	Bushes - Steel - DP4 - Split - Flanged
20.000 -0.000/-0.021	23.000 +0.021/-0.000	25.000 +0.25/-0.25			BP02000-02300-02500-DP4	Bushes - Steel - DP4 - Split - Unflanged
20.000 -0.000/-0.041	23.000 +0.075/-0.000	25.000 +0.00/-0.30			BP02000-02300-02500-DU	Bushes - Steel - DU - Split - Unflanged
20.000 -0.000/-0.041	23.000 +0.075/-0.000	25.000 +0.00/-0.30			BP02000-02300-02500-SS6	Bushes - Stainless Steel and PTFE - Unflanged
20.000 -0.000/-0.041	23.000 +0.075/-0.000	25.000 +0.25/-0.25			BP02000-02300-02500-DX	Bushes - Steel - DX - Split - Unflanged
20.000 -0.000/-0.041	23.000 +0.075/-0.000	30.000 +0.00/-0.30			BP02000-02300-03000-DU	Bushes - Steel - DU - Split - Unflanged
20.000 -0.000/-0.041	23.000 +0.075/-0.000	30.000 +0.00/-0.30			BP02000-02300-03000-SS6	Bushes - Stainless Steel and PTFE - Unflanged
20.000 -0.000/-0.021	23.000 +0.021/-0.000	30.000 +0.25/-0.25			BP02000-02300-03000-DP4	Bushes - Steel - DP4 - Split - Unflanged
20.000 -0.000/-0.041	23.000 +0.075/-0.000	30.000 +0.25/-0.25			BP02000-02300-03000-DUB	Bushes - Steel - DUB - Split - Unflanged
20.000 -0.000/-0.041	23.000 +0.075/-0.000	30.000 +0.25/-0.25			BP02000-02300-03000-DX	Bushes - Steel - DX - Split - Unflanged
20.000 x 24.000 mm (0.787 x 0.945 in.)						
20.000 +0.025/+0.050	24.000 +0.051/+0.076	12.000 +/-0.190	28.00	2.00	BF02000-02400-01200-BS	Bushes - Bronze - Sintered - Flanged
20.000 +0.007/+0.028	24.000 +0.035/+0.056	15.000 +/-0.130			BP02000-02400-01500-BSO	Bushes - Bronze - Sintered - Unflanged - Oilite
20.000 +0.007/+0.028	24.000 +0.035/+0.056	20.000 +/-0.160			BP02000-02400-02000-BSO	Bushes - Bronze - Sintered - Unflanged - Oilite
20.000 +0.007/+0.028	24.000 +0.035/+0.056	25.000 +/-0.160			BP02000-02400-02500-BSO	Bushes - Bronze - Sintered - Unflanged - Oilite
20.000 +/-0.0254	24.000 +0.0508/+0.0762	30.000 +/-0.127			BP02000-02400-03000-BLG	Bushes - Bronze - Solid - Leaded Gunmetal
20.000 +/-0.0254	24.000 +0.0508/+0.0762	40.000 +/-0.127			BP02000-02400-04000-BLG	Bushes - Bronze - Solid - Leaded Gunmetal
20.000 +/-0.0254	24.000 +0.0508/+0.0762	50.000 +/-0.127			BP02000-02400-05000-BLG	Bushes - Bronze - Solid - Leaded Gunmetal
20.000 +/-0.0254	24.000 +0.0508/+0.0762	60.000 +/-0.127			BP02000-02400-06000-BLG	Bushes - Bronze - Solid - Leaded Gunmetal

Stocked or Short Delivery

Usually Available

Long delivery or not in current production

ID	OD	B	DF	bf	Part Number	Type
20.000 x 24.000 mm (0.787 x 0.945 in.)						
20.000 +/-0.0254	24.000 +0.0508/+0.0762	80.000 +/-0.127			BP02000-02400-08000-BLG	Bushes - Bronze - Solid - Leaded Gunmetal
20.000 x 26.000 mm (0.787 x 1.024 in.)						
20.000 +0.007/+0.028	26.000 +0.035/+0.056	15.000 +/-0.130			BP02000-02600-01500-BSO	Bushes - Bronze - Sintered - Unflanged - Oilite
20.000 +0.007/+0.028	26.000 +0.035/+0.056	15.000 +/-0.130	32.00	3.00	BF02000-02600-01500-BSO	Bushes - Bronze - Sintered - Flanged - Oilite
20.000 +0.007/+0.028	26.000 +0.035/+0.056	20.000 +/-0.160			BP02000-02600-02000-BSO	Bushes - Bronze - Sintered - Unflanged - Oilite
20.000 +0.007/+0.028	26.000 +0.035/+0.056	20.000 +/-0.160	32.00	3.00	BF02000-02600-02000-BSO	Bushes - Bronze - Sintered - Flanged - Oilite
20.000 +0/-0.025	26.000 +0/-0.025	25.000 +/-0.127			BP02000-02600-02500-BS	Bushes - Bronze - Sintered - Unflanged
20.000 +0.007/+0.028	26.000 +0.035/+0.056	25.000 +/-0.160	32.00	3.00	BF02000-02600-02500-BSO	Bushes - Bronze - Sintered - Flanged - Oilite
20.000 +0.007/+0.028	26.000 +0.035/+0.056	30.000 +/-0.160	32.00	3.00	BF02000-02600-03000-BSO	Bushes - Bronze - Sintered - Flanged - Oilite
20.000 x 30.000 mm (0.787 x 1.181 in.)						
20.000 +0/-0.025	30.000 +0/-0.025	25.000 +/-0.127			BP02000-03000-02500-BS	Bushes - Bronze - Sintered - Unflanged
20.000 +/-0.0254	30.000 +0.0508/+0.0762	30.000 +/-0.127			BP02000-03000-03000-BLG	Bushes - Bronze - Solid - Leaded Gunmetal
20.000 +/-0.0254	30.000 +0.0508/+0.0762	40.000 +/-0.127			BP02000-03000-04000-BLG	Bushes - Bronze - Solid - Leaded Gunmetal
20.000 +/-0.0254	30.000 +0.0508/+0.0762	50.000 +/-0.127			BP02000-03000-05000-BLG	Bushes - Bronze - Solid - Leaded Gunmetal
20.000 +/-0.0254	30.000 +0.0508/+0.0762	60.000 +/-0.127			BP02000-03000-06000-BLG	Bushes - Bronze - Solid - Leaded Gunmetal
20.000 +/-0.0254	30.000 +0.0508/+0.0762	80.000 +/-0.127			BP02000-03000-08000-BLG	Bushes - Bronze - Solid - Leaded Gunmetal
20.638 x 23.813 mm (0.813 x 0.938 in.)						
20.638 -0.025/-0.053	23.813 +0.013/-0.008	19.050 +0.00/-0.30			BP02064-02381-01905-DP4	Bushes - Steel - DP4 - Split - Unflanged
20.638 -0.025/-0.053	23.813 +0.013/-0.008	19.050 +0.00/-0.30			BP02064-02381-01905-DU	Bushes - Steel - DU - Split - Unflanged
20.638 -0.025/-0.053	23.813 +0.013/-0.008	19.050 +0.25/-0.25			BP02064-02381-01905-SS6	Bushes - Stainless Steel and PTFE - Unflanged
20.638 +/-0.0254	23.813 +0.0508/+0.0762	25.400 +/-0.127			BP02064-02381-02540-BLG	Bushes - Bronze - Solid - Leaded Gunmetal
20.638 -0.025/-0.053	23.813 +0.013/-0.008	28.575 +0.00/-0.30			BP02064-02381-02858-DP4	Bushes - Steel - DP4 - Split - Unflanged
20.638 -0.025/-0.053	23.813 +0.013/-0.008	28.575 +0.00/-0.30			BP02064-02381-02858-DU	Bushes - Steel - DU - Split - Unflanged
20.638 -0.025/-0.053	23.813 +0.013/-0.008	28.575 +0.25/-0.25			BP02064-02381-02858-SS6	Bushes - Stainless Steel and PTFE - Unflanged
20.638 x 25.400 mm (0.813 x 1.000 in.)						
20.638 +0.025/+0.050	25.400 +0.051/+0.076	19.050 +/-0.127			BP02064-02540-01905-BS	Bushes - Bronze - Sintered - Unflanged
20.638 +0.025/+0.050	25.400 +0.051/+0.076	25.400 +/-0.127			BP02064-02540-02540-BS	Bushes - Bronze - Sintered - Unflanged
20.638 +0.025/+0.050	25.400 +0.051/+0.076	31.750 +/-0.127			BP02064-02540-03175-BS	Bushes - Bronze - Sintered - Unflanged
20.638 +0.025/+0.050	25.400 +0.051/+0.076	38.100 +/-0.127			BP02064-02540-03810-BS	Bushes - Bronze - Sintered - Unflanged
20.638 +/-0.0254	25.400 +0.0508/+0.0762	38.100 +/-0.127			BP02064-02540-03810-BLG	Bushes - Bronze - Solid - Leaded Gunmetal
20.638 +0.025/+0.050	25.400 +0.051/+0.076	44.450 +/-0.190			BP02064-02540-04445-BS	Bushes - Bronze - Sintered - Unflanged
20.638 +0.025/+0.050	25.400 +0.051/+0.076	50.800 +/-0.190			BP02064-02540-05080-BS	Bushes - Bronze - Sintered - Unflanged
20.638 +/-0.0254	25.400 +0.0508/+0.0762	50.800 +/-0.127			BP02064-02540-05080-BLG	Bushes - Bronze - Solid - Leaded Gunmetal
20.638 +/-0.0254	25.400 +0.0508/+0.0762	63.500 +/-0.127			BP02064-02540-06350-BLG	Bushes - Bronze - Solid - Leaded Gunmetal
20.638 x 26.988 mm (0.813 x 1.063 in.)						
20.638 +0.025/+0.050	26.988 +0.039/+0.064	25.400 +/-0.127			BP02064-02699-02540-BS	Bushes - Bronze - Sintered - Unflanged
20.638 +0.025/+0.050	26.988 +0.039/+0.064	31.750 +/-0.127			BP02064-02699-03175-BS	Bushes - Bronze - Sintered - Unflanged
20.638 +/-0.0254	26.988 +0.0508/+0.0762	50.800 +/-0.127			BP02064-02699-05080-BLG	Bushes - Bronze - Solid - Leaded Gunmetal
20.638 +/-0.0254	26.988 +0.0508/+0.0762	63.500 +/-0.127			BP02064-02699-06350-BLG	Bushes - Bronze - Solid - Leaded Gunmetal

Stocked or Short Delivery

Usually Available

Long delivery or not in current production

ID	OD	B	DF	bf	Part Number	Type
20.638 x 26.988 mm (0.813 x 1.063 in.)						
20.638 +/-0.0254	26.988 +0.0508/+0.0762	76.200 +/-0.127			BP02064-02699-07620-BLG	Bushes - Bronze - Solid - Leaded Gunmetal
22.000 x 25.000 mm (0.866 x 0.984 in.)						
22.000 -0.000/-0.041	25.000 +0.075/-0.000	10.000 +0.00/-0.30			BP02200-02500-01000-SS6	Bushes - Stainless Steel and PTFE - Unflanged
22.000 -0.000/-0.041	25.000 +0.075/-0.000	10.000 +0.00/-0.30			BP02200-02500-01000-DU	Bushes - Steel - DU - Split - Unflanged
22.000 -0.000/-0.021	25.000 +0.021/-0.000	10.000 +0.25/-0.25			BP02200-02500-01000-DP4	Bushes - Steel - DP4 - Split - Unflanged
22.000 -0.000/-0.041	25.000 +0.075/-0.000	12.000 +0.00/-0.30			BP02200-02500-01200-SS6	Bushes - Stainless Steel and PTFE - Unflanged
22.000 -0.000/-0.041	25.000 +0.075/-0.000	12.000 +0.00/-0.30			BP02200-02500-01200-DU	Bushes - Steel - DU - Split - Unflanged
22.000 -0.000/-0.021	25.000 +0.021/-0.000	12.000 +0.25/-0.25			BP02200-02500-01200-DP4	Bushes - Steel - DP4 - Split - Unflanged
22.000 -0.000/-0.041	25.000 +0.075/-0.000	15.000 +0.00/-0.30			BP02200-02500-01500-DU	Bushes - Steel - DU - Split - Unflanged
22.000 -0.000/-0.021	25.000 +0.021/-0.000	15.000 +0.25/-0.25			BP02200-02500-01500-DP4	Bushes - Steel - DP4 - Split - Unflanged
22.000 -0.000/-0.041	25.000 +0.075/-0.000	15.000 +0.00/-0.30			BP02200-02500-01500-SS6	Bushes - Stainless Steel and PTFE - Unflanged
22.000 -0.000/-0.041	25.000 +0.075/-0.000	15.000 +0.25/-0.25			BP02200-02500-01500-DUB	Bushes - Steel - DUB - Split - Unflanged
22.000 -0.000/-0.041	25.000 +0.075/-0.000	15.000 +0.25/-0.25			BP02200-02500-01500-DX	Bushes - Steel - DX - Split - Unflanged
22.000 -0.000/-0.041	25.000 +0.075/-0.000	15.000 +0.25/-0.25	32.00	1.50	BF02200-02500-01500-DU	Bushes - Steel - DU - Split - Flanged
22.000 -0.000/-0.041	25.000 +0.021/-0.000	15.000 +0.25/-0.25	32.00	1.50	BF02200-02500-01500-DP4	Bushes - Steel - DP4 - Split - Flanged
22.000 -0.000/-0.041	25.000 +0.075/-0.000	15.000 +0.25/-0.25	32.00	1.50	BF02200-02500-01500-SS6	Bushes - Stainless Steel and PTFE - Flanged
22.000 -0.000/-0.041	25.000 +0.075/-0.000	20.000 +0.00/-0.30			BP02200-02500-02000-DU	Bushes - Steel - DU - Split - Unflanged
22.000 -0.000/-0.041	25.000 +0.075/-0.000	20.000 +0.00/-0.30			BP02200-02500-02000-SS6	Bushes - Stainless Steel and PTFE - Unflanged
22.000 -0.000/-0.021	25.000 +0.021/-0.000	20.000 +0.25/-0.25			BP02200-02500-02000-DP4	Bushes - Steel - DP4 - Split - Unflanged
22.000 -0.000/-0.041	25.000 +0.075/-0.000	20.000 +0.25/-0.25			BP02200-02500-02000-DUB	Bushes - Steel - DUB - Split - Unflanged
22.000 -0.000/-0.041	25.000 +0.075/-0.000	20.000 +0.25/-0.25			BP02200-02500-02000-DX	Bushes - Steel - DX - Split - Unflanged
22.000 -0.000/-0.041	25.000 +0.075/-0.000	20.000 +0.25/-0.25	32.00	1.50	BF02200-02500-02000-DU	Bushes - Steel - DU - Split - Flanged
22.000 -0.000/-0.041	25.000 +0.075/-0.000	20.000 +0.25/-0.25	32.00	1.50	BF02200-02500-02000-SS6	Bushes - Stainless Steel and PTFE - Flanged
22.000 -0.000/-0.041	25.000 +0.021/-0.000	20.000 +0.25/-0.25	32.00	1.50	BF02200-02500-02000-DP4	Bushes - Steel - DP4 - Split - Flanged
22.000 -0.000/-0.041	25.000 +0.075/-0.000	25.000 +0.00/-0.30			BP02200-02500-02500-SS6	Bushes - Stainless Steel and PTFE - Unflanged
22.000 -0.000/-0.021	25.000 +0.021/-0.000	25.000 +0.25/-0.25			BP02200-02500-02500-DP4	Bushes - Steel - DP4 - Split - Unflanged
22.000 -0.000/-0.041	25.000 +0.075/-0.000	25.000 +0.00/-0.30			BP02200-02500-02500-DU	Bushes - Steel - DU - Split - Unflanged
22.000 -0.000/-0.041	25.000 +0.075/-0.000	25.000 +0.25/-0.25			BP02200-02500-02500-DUB	Bushes - Steel - DUB - Split - Unflanged
22.000 -0.000/-0.041	25.000 +0.075/-0.000	25.000 +0.25/-0.25			BP02200-02500-02500-DX	Bushes - Steel - DX - Split - Unflanged
22.000 -0.000/-0.041	25.000 +0.075/-0.000	30.000 +0.00/-0.30			BP02200-02500-03000-SS6	Bushes - Stainless Steel and PTFE - Unflanged
22.000 -0.000/-0.021	25.000 +0.021/-0.000	30.000 +0.25/-0.25			BP02200-02500-03000-DP4	Bushes - Steel - DP4 - Split - Unflanged
22.000 -0.000/-0.041	25.000 +0.075/-0.000	30.000 +0.00/-0.30			BP02200-02500-03000-DU	Bushes - Steel - DU - Split - Unflanged
22.000 -0.000/-0.041	25.000 +0.075/-0.000	30.000 +0.25/-0.25			BP02200-02500-03000-DX	Bushes - Steel - DX - Split - Unflanged
22.000 x 28.000 mm (0.866 x 1.102 in.)						
22.000 +0.007/+0.028	28.000 +0.035/+0.056	15.000 +/-0.130			BP02200-02800-01500-BSO	Bushes - Bronze - Sintered - Unflanged - Oilite
22.000 +0.007/+0.028	28.000 +0.035/+0.056	20.000 +/-0.160			BP02200-02800-02000-BSO	Bushes - Bronze - Sintered - Unflanged - Oilite
22.000 +0.007/+0.028	28.000 +0.035/+0.056	25.000 +/-0.160			BP02200-02800-02500-BSO	Bushes - Bronze - Sintered - Unflanged - Oilite
22.000 +0.007/+0.028	28.000 +0.035/+0.056	30.000 +/-0.160			BP02200-02800-03000-BSO	Bushes - Bronze - Sintered - Unflanged - Oilite
22.000 x 32.000 mm (0.866 x 1.260 in.)						
22.000 +0.007/+0.028	32.000 +0.043/+0.068	20.000 +/-0.160			BP02200-03200-02000-BSO	Bushes - Bronze - Sintered - Unflanged - Oilite

 Stocked or Short Delivery

 Usually Available

 Long delivery or not in current production

ID	OD	B	DF	bf	Part Number	Type
22.000 x 32.000 mm (0.866 x 1.260 in.)						
22.000 +0.007/+0.028	32.000 +0.043/+0.068	50.000 +/-0.190			BP02200-03200-05000-BSO	Bushes - Bronze - Sintered - Unflanged - Oilite
22.225 x 25.400 mm (0.875 x 1.000 in.)						
22.225 -0.025/-0.053	25.400 +0.013/-0.008	6.350 +0.25/-0.25			BP02223-02540-00635-SS6	Bushes - Stainless Steel and PTFE - Unflanged
22.225 -0.025/-0.053	25.400 +0.013/-0.008	6.350 +0.00/-0.30			BP02223-02540-00635-DU	Bushes - Steel - DU - Split - Unflanged
22.225 -0.025/-0.053	25.400 +0.013/-0.008	6.350 +0.00/-0.30			BP02223-02540-00635-DP4	Bushes - Steel - DP4 - Split - Unflanged
22.225 -0.025/-0.053	25.400 +0.013/-0.008	9.525 +0.25/-0.25			BP02223-02540-00953-SS6	Bushes - Stainless Steel and PTFE - Unflanged
22.225 -0.025/-0.053	25.400 +0.013/-0.008	9.525 +0.00/-0.30			BP02223-02540-00953-DP4	Bushes - Steel - DP4 - Split - Unflanged
22.225 -0.025/-0.053	25.400 +0.013/-0.008	9.525 +0.00/-0.30			BP02223-02540-00953-DU	Bushes - Steel - DU - Split - Unflanged
22.225 -0.025/-0.053	25.400 +0.013/-0.007	12.700 +0.25/-0.25	30.99	1.73	BF02223-02540-01270-DP4	Bushes - Steel - DP4 - Split - Flanged
22.225 -0.025/-0.053	25.400 +0.013/-0.007	12.700 +0.25/-0.25	30.99	1.73	BF02223-02540-01270-SS6	Bushes - Stainless Steel and PTFE - Flanged
22.225 -0.025/-0.053	25.400 +0.013/-0.007	12.700 +0.25/-0.25	30.99	1.73	BF02223-02540-01270-DU	Bushes - Steel - DU - Split - Flanged
22.225 +0/+0.025	25.400 +0.051/+0.076	15.875 +/-0.127			BP02223-02540-01588-BS	Bushes - Bronze - Sintered - Unflanged
22.225 +0.025/+0.050	25.400 +0.051/+0.076	19.050 +/-0.127			BP02223-02540-01905-BS	Bushes - Bronze - Sintered - Unflanged
22.225 -0.025/-0.053	25.400 +0.013/-0.008	19.050 +0.25/-0.25			BP02223-02540-01905-SS6	Bushes - Stainless Steel and PTFE - Unflanged
22.225 -0.025/-0.053	25.400 +0.013/-0.008	19.050 +0.00/-0.30			BP02223-02540-01905-DU	Bushes - Steel - DU - Split - Unflanged
22.225 -0.025/-0.053	25.400 +0.013/-0.008	19.050 +0.00/-0.30			BP02223-02540-01905-DP4	Bushes - Steel - DP4 - Split - Unflanged
22.225 +0.007/+0.028	25.400 +0.035/+0.056	19.050 +/-0.160			BP02223-02540-01905-BSO	Bushes - Bronze - Sintered - Unflanged - Oilite
22.225 -0.025/-0.053	25.400 +0.013/-0.007	19.050 +0.25/-0.25	30.99	1.73	BF02223-02540-01905-DP4	Bushes - Steel - DP4 - Split - Flanged
22.225 -0.025/-0.053	25.400 +0.013/-0.007	19.050 +0.25/-0.25	30.99	1.73	BF02223-02540-01905-SS6	Bushes - Stainless Steel and PTFE - Flanged
22.225 -0.025/-0.053	25.400 +0.013/-0.007	19.050 +0.25/-0.25	30.99	1.73	BF02223-02540-01905-DU	Bushes - Steel - DU - Split - Flanged
22.225 +0.025/+0.050	25.400 +0.051/+0.076	19.050 +/-0.127	31.75	3.97	BF02223-02540-01905-BS	Bushes - Bronze - Sintered - Flanged
22.225 +0.025/+0.050	25.400 +0.051/+0.076	22.225 +/-0.127			BP02223-02540-02223-BS	Bushes - Bronze - Sintered - Unflanged
22.225 +0.0254/+0.0508	25.400 +0.0508/+0.0762	25.400 +0.127/-0.127			BP02223-02540-02540-BS	Bushes - Bronze - Sintered - Unflanged
22.225 -0.025/-0.053	25.400 +0.013/-0.008	25.400 +0.00/-0.30			BP02223-02540-02540-DU	Bushes - Steel - DU - Split - Unflanged
22.225 +0.007/+0.028	25.400 +0.035/+0.056	25.400 +/-0.160			BP02223-02540-02540-BSO	Bushes - Bronze - Sintered - Unflanged - Oilite
22.225 -0.025/-0.053	25.400 +0.013/-0.008	25.400 +0.25/-0.25			BP02223-02540-02540-SS6	Bushes - Stainless Steel and PTFE - Unflanged
22.225 -0.025/-0.053	25.400 +0.013/-0.008	25.400 +0.00/-0.30			BP02223-02540-02540-DP4	Bushes - Steel - DP4 - Split - Unflanged
22.225 +0.0254/+0.0508	25.400 +0.0508/+0.0762	25.400 +0.127/-0.127			BP02223-02540-02540-BFG	Bushes - Bronze - Sintered - ECO841 Food Grade - Unflanged
22.225 +/-0.0254	25.400 +0.0508/+0.0762	25.400 +/-0.127			BP02223-02540-02540-BC9	Bushes - Bronze - Solid - Leaded Gunmetal
22.225 +/-0.0254	25.400 +0.0508/+0.0762	25.400 +/-0.127			BP02223-02540-02540-BLG	Bushes - Bronze - Solid - Leaded Gunmetal
22.225 -0.025/-0.053	25.400 +0.013/-0.007	25.400 +0.25/-0.25	30.99	1.73	BF02223-02540-02540-SS6	Bushes - Stainless Steel and PTFE - Flanged
22.225 -0.025/-0.053	25.400 +0.013/-0.007	25.400 +0.25/-0.25	30.99	1.73	BF02223-02540-02540-DU	Bushes - Steel - DU - Split - Flanged
22.225 -0.025/-0.053	25.400 +0.013/-0.007	25.400 +0.25/-0.25	30.99	1.73	BF02223-02540-02540-DP4	Bushes - Steel - DP4 - Split - Flanged
22.225 +0.025/+0.050	25.400 +0.051/+0.076	25.400 +/-0.127	31.75	3.97	BF02223-02540-02540-BS	Bushes - Bronze - Sintered - Flanged
22.225 +0.025/+0.050	25.400 +0.051/+0.076	31.750 +/-0.127			BP02223-02540-03175-BS	Bushes - Bronze - Sintered - Unflanged
22.225 -0.025/-0.053	25.400 +0.013/-0.008	31.750 +0.00/-0.30			BP02223-02540-03175-DP4	Bushes - Steel - DP4 - Split - Unflanged
22.225 +0.007/+0.028	25.400 +0.035/+0.056	31.750 +/-0.190			BP02223-02540-03175-BSO	Bushes - Bronze - Sintered - Unflanged - Oilite
22.225 -0.025/-0.053	25.400 +0.013/-0.008	31.750 +0.25/-0.25			BP02223-02540-03175-SS6	Bushes - Stainless Steel and PTFE - Unflanged
22.225 -0.025/-0.053	25.400 +0.013/-0.008	31.750 +0.00/-0.30			BP02223-02540-03175-DU	Bushes - Steel - DU - Split - Unflanged
22.225 +/-0.0254	25.400 +0.0508/+0.0762	31.750 +/-0.127			BP02223-02540-03175-BLG	Bushes - Bronze - Solid - Leaded Gunmetal

Stocked or Short Delivery

Usually Available

Long delivery or not in current production

ID	OD	B	DF	bf	Part Number	Type
22.225 x 25.400 mm (0.875 x 1.000 in.)						
22.225 -0.025/-0.053	25.400 +0.013/-0.007	31.750 +0.25/-0.25	30.99	1.73	BF02223-02540-03175-SS6	Bushes - Stainless Steel and PTFE - Flanged
22.225 -0.025/-0.053	25.400 +0.013/-0.007	31.750 +0.25/-0.25	30.99	1.73	BF02223-02540-03175-DP4	Bushes - Steel - DP4 - Split - Flanged
22.225 -0.025/-0.053	25.400 +0.013/-0.007	31.750 +0.25/-0.25	30.99	1.73	BF02223-02540-03175-DU	Bushes - Steel - DU - Split - Flanged
22.225 +0.025/+0.050	25.400 +0.051/+0.076	31.750 +/-0.127	31.75	3.97	BF02223-02540-03175-BS	Bushes - Bronze - Sintered - Flanged
22.225 +0.025/+0.050	25.400 +0.051/+0.076	38.100 +/-0.127			BP02223-02540-03810-BS	Bushes - Bronze - Sintered - Unflanged
22.225 +0.007/+0.028	25.400 +0.035/+0.056	38.100 +/-0.190			BP02223-02540-03810-BSO	Bushes - Bronze - Sintered - Unflanged - Oilite
22.225 +/-0.0254	25.400 +0.0508/+0.0762	38.100 +/-0.127			BP02223-02540-03810-BLG	Bushes - Bronze - Solid - Leaded Gunmetal
22.225 +0.025/+0.050	25.400 +0.051/+0.076	44.450 +/-0.190			BP02223-02540-04445-BS	Bushes - Bronze - Sintered - Unflanged
22.225 +/-0.0254	25.400 +0.0508/+0.0762	50.800 +/-0.127			BP02223-02540-05080-BC9	Bushes - Bronze - Solid - Leaded Gunmetal
22.225 +/-0.0254	25.400 +0.0508/+0.0762	50.800 +/-0.127			BP02223-02540-05080-BLG	Bushes - Bronze - Solid - Leaded Gunmetal
22.225 +/-0.0254	25.400 +0.0508/+0.0762	63.500 +/-0.127			BP02223-02540-06350-BLG	Bushes - Bronze - Solid - Leaded Gunmetal
22.225 +/-0.0254	25.400 +0.0508/+0.0762	76.200 +/-0.127			BP02223-02540-07620-BLG	Bushes - Bronze - Solid - Leaded Gunmetal
22.225 x 26.988 mm (0.875 x 1.063 in.)						
22.225 +0.025/+0.050	26.988 +0.052/+0.077	25.400 +/-0.127			BP02223-02699-02540-BS	Bushes - Bronze - Sintered - Unflanged
22.225 +/-0.0254	26.988 +0.0508/+0.0762	25.400 +/-0.127			BP02223-02699-02540-BLG	Bushes - Bronze - Solid - Leaded Gunmetal
22.225 +0.025/+0.050	26.988 +0.052/+0.077	31.750 +/-0.127			BP02223-02699-03175-BS	Bushes - Bronze - Sintered - Unflanged
22.225 +/-0.0254	26.988 +0.0508/+0.0762	38.100 +/-0.127			BP02223-02699-03810-BLG	Bushes - Bronze - Solid - Leaded Gunmetal
22.225 +/-0.0254	26.988 +0.0508/+0.0762	50.800 +/-0.127			BP02223-02699-05080-BLG	Bushes - Bronze - Solid - Leaded Gunmetal
22.225 +/-0.0254	26.988 +0.0508/+0.0762	63.500 +/-0.127			BP02223-02699-06350-BLG	Bushes - Bronze - Solid - Leaded Gunmetal
22.225 x 28.575 mm (0.875 x 1.125 in.)						
22.225 +0.0254/+0.0508	28.575 +0.0508/+0.0762	19.050 +0.127/-0.127			BP02223-02858-01905-BS	Bushes - Bronze - Sintered - Unflanged
22.225 +0.007/+0.028	28.575 +0.035/+0.056	19.050 +/-0.160			BP02223-02858-01905-BSO	Bushes - Bronze - Sintered - Unflanged - Oilite
22.225 +0.0254/+0.0508	28.575 +0.0508/+0.0762	19.050 +0.127/-0.127			BP02223-02858-01905-BFG	Bushes - Bronze - Sintered - ECO841 Food Grade - Unflanged
22.225 +0.007/+0.028	28.575 +0.035/+0.056	19.050 +/-0.160	41.28	3.18	BF02223-02858-01905-BSO	Bushes - Bronze - Sintered - Flanged - Oilite
22.225 +0.025/+0.050	28.575 +0.051/+0.076	22.225 +/-0.127			BP02223-02858-02223-BS	Bushes - Bronze - Sintered - Unflanged
22.225 +0.007/+0.028	28.575 +0.035/+0.056	22.225 +/-0.160			BP02223-02858-02223-BSO	Bushes - Bronze - Sintered - Unflanged - Oilite
22.225 +0.0254/+0.0508	28.575 +0.0508/+0.0762	25.400 +0.127/-0.127			BP02223-02858-02540-BS	Bushes - Bronze - Sintered - Unflanged
22.225 +0.0254/+0.0508	28.575 +0.0508/+0.0762	25.400 +0.127/-0.127			BP02223-02858-02540-BFG	Bushes - Bronze - Sintered - ECO841 Food Grade - Unflanged
22.225 +0.007/+0.028	28.575 +0.035/+0.056	25.400 +/-0.160			BP02223-02858-02540-BSO	Bushes - Bronze - Sintered - Unflanged - Oilite
22.225 +0.025/+0.050	28.575 +0.051/+0.076	25.400 +/-0.127	34.93	3.97	BF02223-02858-02540-BS	Bushes - Bronze - Sintered - Flanged
22.225 +0.007/+0.028	28.575 +0.035/+0.056	25.400 +/-0.160	41.28	3.18	BF02223-02858-02540-BSO	Bushes - Bronze - Sintered - Flanged - Oilite
22.225 +0.025/+0.050	28.575 +0.051/+0.076	28.575 +/-0.127			BP02223-02858-02858-BS	Bushes - Bronze - Sintered - Unflanged
22.225 +0.0254/+0.0508	28.575 +0.0508/+0.0762	31.750 +0.127/-0.127			BP02223-02858-03175-BS	Bushes - Bronze - Sintered - Unflanged
22.225 +0.007/+0.028	28.575 +0.035/+0.056	31.750 +/-0.190			BP02223-02858-03175-BSO	Bushes - Bronze - Sintered - Unflanged - Oilite
22.225 +0.0254/+0.0508	28.575 +0.0508/+0.0762	31.750 +0.127/-0.127			BP02223-02858-03175-BFG	Bushes - Bronze - Sintered - ECO841 Food Grade - Unflanged
22.225 +/-0.0254	28.575 +0.0508/+0.0762	31.750 +/-0.127			BP02223-02858-03175-BLG	Bushes - Bronze - Solid - Leaded Gunmetal
22.225 +0.007/+0.028	28.575 +0.035/+0.056	31.750 +/-0.190	41.28	3.18	BF02223-02858-03175-BSO	Bushes - Bronze - Sintered - Flanged - Oilite
22.225 +0.025/+0.050	28.575 +0.051/+0.076	34.925 +/-0.127			BP02223-02858-03493-BS	Bushes - Bronze - Sintered - Unflanged
22.225 +0.025/+0.050	28.575 +0.051/+0.076	38.100 +/-0.127			BP02223-02858-03810-BS	Bushes - Bronze - Sintered - Unflanged

 Stocked or Short Delivery

 Usually Available

 Long delivery or not in current production

ID	OD	B	DF	bf	Part Number	Type
----	----	---	----	----	-------------	------

22.225 x 28.575 mm (0.875 x 1.125 in.)						
22.225 +0.007/+0.028	28.575 +0.035/+0.056	38.100 +/-0.190			BP02223-02858-03810-BSO	Bushes - Bronze - Sintered - Unflanged - Oilite
22.225 +/-0.0254	28.575 +0.0508/+0.0762	38.100 +/-0.127			BP02223-02858-03810-BLG	Bushes - Bronze - Solid - Leaded Gunmetal
22.225 +0.025/+0.050	28.575 +0.051/+0.076	38.100 +/-0.127	34.93	3.97	BF02223-02858-03810-BS	Bushes - Bronze - Sintered - Flanged
22.225 +0.007/+0.028	28.575 +0.035/+0.056	38.100 +/-0.190	41.28	3.18	BF02223-02858-03810-BSO	Bushes - Bronze - Sintered - Flanged - Oilite
22.225 +0.025/+0.050	28.575 +0.051/+0.076	41.275 +/-0.190			BP02223-02858-04128-BS	Bushes - Bronze - Sintered - Unflanged
22.225 +0.025/+0.050	28.575 +0.051/+0.076	44.450 +/-0.190			BP02223-02858-04445-BS	Bushes - Bronze - Sintered - Unflanged
22.225 +0.025/+0.050	28.575 +0.051/+0.076	50.800 +/-0.190			BP02223-02858-05080-BS	Bushes - Bronze - Sintered - Unflanged
22.225 +/-0.0254	28.575 +0.0508/+0.0762	50.800 +/-0.127			BP02223-02858-05080-BLG	Bushes - Bronze - Solid - Leaded Gunmetal
22.225 +0.025/+0.050	28.575 +0.051/+0.076	57.150 +/-0.190			BP02223-02858-05715-BS	Bushes - Bronze - Sintered - Unflanged
22.225 +/-0.0254	28.575 +0.0508/+0.0762	57.150 +/-0.127			BP02223-02858-05715-BLG	Bushes - Bronze - Solid - Leaded Gunmetal
22.225 +0.025/+0.050	28.575 +0.051/+0.076	63.500 +/-0.190			BP02223-02858-06350-BS	Bushes - Bronze - Sintered - Unflanged
22.225 +/-0.0254	28.575 +0.0508/+0.0762	63.500 +/-0.127			BP02223-02858-06350-BLG	Bushes - Bronze - Solid - Leaded Gunmetal
22.225 +/-0.0254	28.575 +0.0508/+0.0762	76.200 +/-0.127			BP02223-02858-07620-BLG	Bushes - Bronze - Solid - Leaded Gunmetal

22.225 x 31.750 mm (0.875 x 1.250 in.)						
22.225 +0.025/+0.050	31.750 +0.051/+0.076	19.050 +/-0.127			BP02223-03175-01905-BS	Bushes - Bronze - Sintered - Unflanged
22.225 +0.013/-0.000	31.750 +0.013/-0.000	22.225 +0.00/-1.52	36.32	4.76	BF02223-03175-02223-BA	Bushes - Aluminium Bronze - Flanged
22.225 +0.013/-0.000	31.750 +0.013/-0.000	22.225 +0.00/-1.52	36.32	4.76	BF02223-03175-02223-BAG	Bushes - Aluminium Bronze - Graphite Plug - Flanged
22.225 +0.025/+0.050	31.750 +0.051/+0.076	25.400 +/-0.127			BP02223-03175-02540-BS	Bushes - Bronze - Sintered - Unflanged
22.225 +0.013/-0.000	31.750 +0.013/-0.000	31.750 +0.00/-1.52			BP02223-03175-03175-BAG	Bushes - Aluminium Bronze - Graphite Plug - Unflanged
22.225 +0.025/+0.050	31.750 +0.051/+0.076	31.750 +/-0.127			BP02223-03175-03175-BS	Bushes - Bronze - Sintered - Unflanged
22.225 +0.013/-0.000	31.750 +0.013/-0.000	34.925 +0.00/-1.52	36.32	4.76	BF02223-03175-03493-BAG	Bushes - Aluminium Bronze - Graphite Plug - Flanged
22.225 +0.013/-0.000	31.750 +0.013/-0.000	34.925 +0.00/-1.52	36.32	4.76	BF02223-03175-03493-BA	Bushes - Aluminium Bronze - Flanged
22.225 +0.025/+0.050	31.750 +0.051/+0.076	38.100 +/-0.127			BP02223-03175-03810-BS	Bushes - Bronze - Sintered - Unflanged
22.225 +0.013/-0.000	31.750 +0.013/-0.000	38.100 +0.00/-1.52			BP02223-03175-03810-BAG	Bushes - Aluminium Bronze - Graphite Plug - Unflanged
22.225 +/-0.0254	31.750 +0.0508/+0.0762	38.100 +/-0.127			BP02223-03175-03810-BLG	Bushes - Bronze - Solid - Leaded Gunmetal
22.225 +0.013/-0.000	31.750 +0.013/-0.000	47.625 +0.00/-1.52	36.32	4.76	BF02223-03175-04763-BAG	Bushes - Aluminium Bronze - Graphite Plug - Flanged
22.225 +0.013/-0.000	31.750 +0.013/-0.000	47.625 +0.00/-1.52	36.32	4.76	BF02223-03175-04763-BA	Bushes - Aluminium Bronze - Flanged
22.225 +0.025/+0.050	31.750 +0.051/+0.076	50.800 +/-0.190			BP02223-03175-05080-BS	Bushes - Bronze - Sintered - Unflanged
22.225 +/-0.0254	31.750 +0.0508/+0.0762	50.800 +/-0.127			BP02223-03175-05080-BLG	Bushes - Bronze - Solid - Leaded Gunmetal
22.225 +0.013/-0.000	31.750 +0.013/-0.000	60.325 +0.00/-1.52	36.32	4.76	BF02223-03175-06033-BA	Bushes - Aluminium Bronze - Flanged
22.225 +/-0.0254	31.750 +0.0508/+0.0762	63.500 +/-0.127			BP02223-03175-06350-BLG	Bushes - Bronze - Solid - Leaded Gunmetal
22.225 +0.013/-0.000	31.750 +0.013/-0.000	73.025 +0.00/-1.52	36.32	4.76	BF02223-03175-07303-BA	Bushes - Aluminium Bronze - Flanged
22.225 +0.013/-0.000	31.750 +0.013/-0.000	73.025 +0.00/-1.52	36.32	4.76	BF02223-03175-07303-BAG	Bushes - Aluminium Bronze - Graphite Plug - Flanged
22.225 +/-0.0254	31.750 +0.0508/+0.0762	76.200 +/-0.127			BP02223-03175-07620-BLG	Bushes - Bronze - Solid - Leaded Gunmetal
22.225 +0.013/-0.000	31.750 +0.013/-0.000	85.725 +0.00/-1.52	36.32	4.76	BF02223-03175-08573-BAG	Bushes - Aluminium Bronze - Graphite Plug - Flanged
22.225 +0.013/-0.000	31.750 +0.013/-0.000	85.725 +0.00/-1.52	36.32	4.76	BF02223-03175-08573-BA	Bushes - Aluminium Bronze - Flanged
22.225 +0.013/-0.000	31.750 +0.013/-0.000	98.425 +0.00/-1.52	36.32	4.76	BF02223-03175-09843-BAG	Bushes - Aluminium Bronze - Graphite Plug - Flanged
22.225 +0.013/-0.000	31.750 +0.013/-0.000	98.425 +0.00/-1.52	36.32	4.76	BF02223-03175-09843-BA	Bushes - Aluminium Bronze - Flanged
22.225 +0.013/-0.000	31.750 +0.013/-0.000	111.125 +0.00/-1.52	36.32	4.76	BF02223-03175-11113-BAG	Bushes - Aluminium Bronze - Graphite Plug - Flanged

Stocked or Short Delivery

Usually Available

Long delivery or not in current production

ID	OD	B	DF	bf	Part Number	Type
23.225 x 34.925 mm (0.875 x 1.375 in.)						
22.225 +/-0.0254	34.925 +0.0508/+0.0762	76.200 +/-0.127			BP02223-03493-07620-BLG	Bushes - Bronze - Solid - Leaded Gunmetal
23.813 x 26.988 mm (0.938 x 1.063 in.)						
23.813 +/-0.0254	26.988 +0.0508/+0.0762	38.100 +/-0.127			BP02381-02699-03810-BLG	Bushes - Bronze - Solid - Leaded Gunmetal
23.813 +/-0.0254	26.988 +0.0508/+0.0762	50.800 +/-0.127			BP02381-02699-05080-BLG	Bushes - Bronze - Solid - Leaded Gunmetal
23.813 +/-0.0254	26.988 +0.0508/+0.0762	63.500 +/-0.127			BP02381-02699-06350-BLG	Bushes - Bronze - Solid - Leaded Gunmetal
23.813 x 28.575 mm (0.938 x 1.125 in.)						
23.813 +/-0.0254	28.575 +0.0508/+0.0762	31.750 +/-0.127			BP02381-02858-03175-BLG	Bushes - Bronze - Solid - Leaded Gunmetal
23.813 +/-0.0254	28.575 +0.0508/+0.0762	57.150 +/-0.127			BP02381-02858-05715-BLG	Bushes - Bronze - Solid - Leaded Gunmetal
23.813 +/-0.0254	28.575 +0.0508/+0.0762	76.200 +/-0.127			BP02381-02858-07620-BLG	Bushes - Bronze - Solid - Leaded Gunmetal
23.813 x 30.163 mm (0.938 x 1.188 in.)						
23.813 +0.025/+0.050	30.163 +0.039/+0.064	19.050 +/-0.127			BP02381-03016-01905-BS	Bushes - Bronze - Sintered - Unflanged
23.813 +0.025/+0.050	30.163 +0.039/+0.064	25.400 +/-0.127			BP02381-03016-02540-BS	Bushes - Bronze - Sintered - Unflanged
23.813 +0.025/+0.050	30.163 +0.039/+0.064	31.750 +/-0.127			BP02381-03016-03175-BS	Bushes - Bronze - Sintered - Unflanged
23.813 +0.025/+0.050	30.163 +0.039/+0.064	38.100 +/-0.127			BP02381-03016-03810-BS	Bushes - Bronze - Sintered - Unflanged
23.813 +0.025/+0.050	30.163 +0.039/+0.064	50.800 +/-0.190			BP02381-03016-05080-BS	Bushes - Bronze - Sintered - Unflanged
23.813 +/-0.0254	30.163 +0.0508/+0.0762	50.800 +/-0.127			BP02381-03016-05080-BLG	Bushes - Bronze - Solid - Leaded Gunmetal
23.813 x 31.750 mm (0.938 x 1.250 in.)						
23.813 +0.025/+0.050	31.750 +0.077/+0.102	19.050 +/-0.127			BP02381-03175-01905-BS	Bushes - Bronze - Sintered - Unflanged
23.813 +0/-0.025	31.750 +0.051/+0.076	25.400 +/-0.127			BP02381-03175-02540-BS00	Bushes - Bronze - Sintered - Unflanged
23.813 +0.025/+0.050	31.750 +0.077/+0.102	25.400 +/-0.127			BP02381-03175-02540-BS05	Bushes - Bronze - Sintered - Unflanged
23.813 +0.025/+0.050	31.750 +0.077/+0.102	31.750 +/-0.127			BP02381-03175-03175-BS	Bushes - Bronze - Sintered - Unflanged
23.813 +0.025/+0.050	31.750 +0.077/+0.102	38.100 +/-0.127			BP02381-03175-03810-BS	Bushes - Bronze - Sintered - Unflanged
23.813 +0.025/+0.050	31.750 +0.077/+0.102	44.450 +/-0.190			BP02381-03175-04445-BS	Bushes - Bronze - Sintered - Unflanged
23.813 +0.025/+0.050	31.750 +0.077/+0.102	50.800 +/-0.190			BP02381-03175-05080-BS	Bushes - Bronze - Sintered - Unflanged
24.000 x 27.000 mm (0.945 x 1.063 in.)						
24.000 -0.000/-0.021	27.000 +0.021/-0.000	15.000 +0.25/-0.25			BP02400-02700-01500-DP4	Bushes - Steel - DP4 - Split - Unflanged
24.000 -0.000/-0.041	27.000 +0.075/-0.000	15.000 +0.00/-0.30			BP02400-02700-01500-DU	Bushes - Steel - DU - Split - Unflanged
24.000 -0.000/-0.041	27.000 +0.075/-0.000	15.000 +0.00/-0.30			BP02400-02700-01500-SS6	Bushes - Stainless Steel and PTFE - Unflanged
24.000 -0.000/-0.041	27.000 +0.075/-0.000	15.000 +0.25/-0.25			BP02400-02700-01500-DX	Bushes - Steel - DX - Split - Unflanged
24.000 -0.000/-0.021	27.000 +0.021/-0.000	20.000 +0.25/-0.25			BP02400-02700-02000-DP4	Bushes - Steel - DP4 - Split - Unflanged
24.000 -0.000/-0.041	27.000 +0.075/-0.000	20.000 +0.00/-0.30			BP02400-02700-02000-SS6	Bushes - Stainless Steel and PTFE - Unflanged
24.000 -0.000/-0.041	27.000 +0.075/-0.000	20.000 +0.00/-0.30			BP02400-02700-02000-DU	Bushes - Steel - DU - Split - Unflanged
24.000 -0.000/-0.041	27.000 +0.075/-0.000	20.000 +0.25/-0.25			BP02400-02700-02000-DX	Bushes - Steel - DX - Split - Unflanged
24.000 -0.000/-0.021	27.000 +0.021/-0.000	25.000 +0.25/-0.25			BP02400-02700-02500-DP4	Bushes - Steel - DP4 - Split - Unflanged
24.000 -0.000/-0.041	27.000 +0.075/-0.000	25.000 +0.00/-0.30			BP02400-02700-02500-DU	Bushes - Steel - DU - Split - Unflanged
24.000 -0.000/-0.041	27.000 +0.075/-0.000	25.000 +0.00/-0.30			BP02400-02700-02500-SS6	Bushes - Stainless Steel and PTFE - Unflanged
24.000 -0.000/-0.041	27.000 +0.075/-0.000	25.000 +0.25/-0.25			BP02400-02700-02500-DX	Bushes - Steel - DX - Split - Unflanged
24.000 -0.000/-0.021	27.000 +0.021/-0.000	30.000 +0.25/-0.25			BP02400-02700-03000-DP4	Bushes - Steel - DP4 - Split - Unflanged
24.000 -0.000/-0.041	27.000 +0.075/-0.000	30.000 +0.00/-0.30			BP02400-02700-03000-DU	Bushes - Steel - DU - Split - Unflanged

Stocked or Short Delivery

Usually Available

Long delivery or not in current production

ID	OD	B	DF	bf	Part Number	Type
24.000 x 27.000 mm (0.945 x 1.063 in.)						
24.000 -0.000/-0.041	27.000 +0.075/-0.000	30.000 +0.00/-0.30			BP02400-02700-03000-SS6	Bushes - Stainless Steel and PTFE - Unflanged
24.000 -0.000/-0.021	27.000 +0.075/-0.000	30.000 +0.25/-0.25			BP02400-02700-03000-DX	Bushes - Steel - DX - Split - Unflanged
25.000 x 28.000 mm (0.984 x 1.102 in.)						
25.000 -0.000/-0.041	28.000 +0.075/-0.000	10.000 +0.00/-0.30			BP02500-02800-01000-DP4	Bushes - Steel - DP4 - Split - Unflanged
25.000 -0.000/-0.041	28.000 +0.075/-0.000	10.000 +0.00/-0.30			BP02500-02800-01000-DU	Bushes - Steel - DU - Split - Unflanged
25.000 -0.000/-0.041	28.000 +0.075/-0.000	10.000 +0.00/-0.30			BP02500-02800-01000-SS6	Bushes - Stainless Steel and PTFE - Unflanged
25.000 -0.000/-0.041	28.000 +0.075/-0.000	11.500 +0.25/-0.25	35.00	1.40	BF02500-02800-01150-DUB	Bushes - Steel - DUB - Split - Flanged
25.000 -0.000/-0.041	28.000 +0.075/-0.000	11.500 +0.25/-0.25	35.00	1.50	BF02500-02800-01150-SS6	Bushes - Stainless Steel and PTFE - Flanged
25.000 -0.000/-0.041	28.000 +0.075/-0.000	11.500 +0.25/-0.25	35.00	1.50	BF02500-02800-01150-DU	Bushes - Steel - DU - Split - Flanged
25.000 -0.000/-0.021	28.000 +0.021/-0.000	11.500 +0.25/-0.25	35.00	1.50	BF02500-02800-01150-DP4	Bushes - Steel - DP4 - Split - Flanged
25.000 -0.000/-0.041	28.000 +0.075/-0.000	12.000 +0.00/-0.30			BP02500-02800-01200-DP4	Bushes - Steel - DP4 - Split - Unflanged
25.000 -0.000/-0.041	28.000 +0.075/-0.000	12.000 +0.00/-0.30			BP02500-02800-01200-SS6	Bushes - Stainless Steel and PTFE - Unflanged
25.000 -0.000/-0.041	28.000 +0.075/-0.000	12.000 +0.00/-0.30			BP02500-02800-01200-DU	Bushes - Steel - DU - Split - Unflanged
25.000 -0.000/-0.021	28.000 +0.021/-0.000	15.000 +0.25/-0.25			BP02500-02800-01500-DP4	Bushes - Steel - DP4 - Split - Unflanged
25.000 -0.000/-0.041	28.000 +0.075/-0.000	15.000 +0.00/-0.30			BP02500-02800-01500-DU	Bushes - Steel - DU - Split - Unflanged
25.000 -0.000/-0.041	28.000 +0.075/-0.000	15.000 +0.00/-0.30			BP02500-02800-01500-SS6	Bushes - Stainless Steel and PTFE - Unflanged
25.000 -0.000/-0.041	28.000 +0.075/-0.000	15.000 +0.25/-0.25			BP02500-02800-01500-DUB	Bushes - Steel - DUB - Split - Unflanged
25.000 -0.000/-0.041	28.000 +0.075/-0.000	15.000 +0.25/-0.25			BP02500-02800-01500-DX	Bushes - Steel - DX - Split - Unflanged
25.000 -0.000/-0.021	28.000 +0.021/-0.000	16.500 +0.25/-0.25	35.00	1.50	BF02500-02800-01650-DP4	Bushes - Steel - DP4 - Split - Flanged
25.000 -0.000/-0.041	28.000 +0.075/-0.000	16.500 +0.25/-0.25	35.00	1.50	BF02500-02800-01650-SS6	Bushes - Stainless Steel and PTFE - Flanged
25.000 -0.000/-0.041	28.000 +0.075/-0.000	16.500 +0.25/-0.25	35.00	1.50	BF02500-02800-01650-DU	Bushes - Steel - DU - Split - Flanged
25.000 -0.000/-0.021	28.000 +0.021/-0.000	20.000 +0.25/-0.25			BP02500-02800-02000-DP4	Bushes - Steel - DP4 - Split - Unflanged
25.000 -0.000/-0.041	28.000 +0.075/-0.000	20.000 +0.00/-0.30			BP02500-02800-02000-DU	Bushes - Steel - DU - Split - Unflanged
25.000 -0.000/-0.041	28.000 +0.075/-0.000	20.000 +0.00/-0.30			BP02500-02800-02000-SS6	Bushes - Stainless Steel and PTFE - Unflanged
25.000 -0.000/-0.041	28.000 +0.075/-0.000	20.000 +0.25/-0.25			BP02500-02800-02000-DX	Bushes - Steel - DX - Split - Unflanged
25.000 -0.000/-0.041	28.000 +0.075/-0.000	21.500 +0.25/-0.25	35.00	1.40	BF02500-02800-02150-DUB	Bushes - Steel - DUB - Split - Flanged
25.000 -0.000/-0.021	28.000 +0.021/-0.000	21.500 +0.25/-0.25	35.00	1.50	BF02500-02800-02150-DP4	Bushes - Steel - DP4 - Split - Flanged
25.000 -0.000/-0.041	28.000 +0.075/-0.000	21.500 +0.25/-0.25	35.00	1.50	BF02500-02800-02150-DU	Bushes - Steel - DU - Split - Flanged
25.000 -0.000/-0.041	28.000 +0.075/-0.000	21.500 +0.25/-0.25	35.00	1.50	BF02500-02800-02150-SS6	Bushes - Stainless Steel and PTFE - Flanged
25.000 -0.000/-0.041	28.000 +0.075/-0.000	25.000 +0.00/-0.30			BP02500-02800-02500-SS6	Bushes - Stainless Steel and PTFE - Unflanged
25.000 -0.000/-0.021	28.000 +0.021/-0.000	25.000 +0.25/-0.25			BP02500-02800-02500-DP4	Bushes - Steel - DP4 - Split - Unflanged
25.000 -0.000/-0.041	28.000 +0.075/-0.000	25.000 +0.00/-0.30			BP02500-02800-02500-DU	Bushes - Steel - DU - Split - Unflanged
25.000 -0.000/-0.041	28.000 +0.075/-0.000	25.000 +0.25/-0.25			BP02500-02800-02500-DUB	Bushes - Steel - DUB - Split - Unflanged
25.000 -0.000/-0.041	28.000 +0.075/-0.000	25.000 +0.25/-0.25			BP02500-02800-02500-DX	Bushes - Steel - DX - Split - Unflanged
25.000 -0.000/-0.041	28.000 +0.075/-0.000	30.000 +0.00/-0.30			BP02500-02800-03000-DU	Bushes - Steel - DU - Split - Unflanged
25.000 -0.000/-0.041	28.000 +0.075/-0.000	30.000 +0.00/-0.30			BP02500-02800-03000-SS6	Bushes - Stainless Steel and PTFE - Unflanged
25.000 -0.000/-0.021	28.000 +0.021/-0.000	30.000 +0.25/-0.25			BP02500-02800-03000-DP4	Bushes - Steel - DP4 - Split - Unflanged
25.000 -0.000/-0.041	28.000 +0.075/-0.000	30.000 +0.25/-0.25			BP02500-02800-03000-DX	Bushes - Steel - DX - Split - Unflanged
25.000 -0.000/-0.041	28.000 +0.075/-0.000	40.000 +0.00/-0.30			BP02500-02800-04000-DP4	Bushes - Steel - DP4 - Split - Unflanged
25.000 -0.000/-0.041	28.000 +0.075/-0.000	40.000 +0.00/-0.30			BP02500-02800-04000-DU	Bushes - Steel - DU - Split - Unflanged
25.000 -0.000/-0.041	28.000 +0.075/-0.000	40.000 +0.00/-0.30			BP02500-02800-04000-SS6	Bushes - Stainless Steel and PTFE - Unflanged

 Stocked or Short Delivery

 Usually Available

 Long delivery or not in current production

ID	OD	B	DF	bf	Part Number	Type
25.000 x 28.000 mm (0.984 x 1.102 in.)						
25.000 -0.000/-0.021	28.000 +0.021/-0.000	50.000 +0.25/-0.25			BP02500-02800-05000-DP4	Bushes - Steel - DP4 - Split - Unflanged
25.000 -0.000/-0.041	28.000 +0.075/-0.000	50.000 +0.00/-0.30			BP02500-02800-05000-DU	Bushes - Steel - DU - Split - Unflanged
25.000 -0.000/-0.041	28.000 +0.075/-0.000	50.000 +0.00/-0.30			BP02500-02800-05000-SS6	Bushes - Stainless Steel and PTFE - Unflanged
25.000 x 30.000 mm (0.984 x 1.181 in.)						
25.000 +0.007/+0.028	30.000 +0.035/+0.056	20.000 +/-0.160			BP02500-03000-02000-BSO	Bushes - Bronze - Sintered - Unflanged - Oilite
25.000 +0.007/+0.028	30.000 +0.035/+0.056	20.000 +/-0.160	39.00	4.00	BF02500-03000-02000-BSO	Bushes - Bronze - Sintered - Flanged - Oilite
25.000 +0.007/+0.028	30.000 +0.035/+0.056	25.000 +/-0.160			BP02500-03000-02500-BSO	Bushes - Bronze - Sintered - Unflanged - Oilite
25.000 +0.007/+0.028	30.000 +0.035/+0.056	25.000 +/-0.160	39.00	4.00	BF02500-03000-02500-BSO	Bushes - Bronze - Sintered - Flanged - Oilite
25.000 +0.007/+0.028	30.000 +0.035/+0.056	30.000 +/-0.160			BP02500-03000-03000-BSO	Bushes - Bronze - Sintered - Unflanged - Oilite
25.000 +/-0.0254	30.000 +0.0508/+0.0762	30.000 +/-0.127			BP02500-03000-03000-BLG	Bushes - Bronze - Solid - Leaded Gunmetal
25.000 +0.007/+0.028	30.000 +0.035/+0.056	32.000 +/-0.190	39.00	4.00	BF02500-03000-03200-BSO	Bushes - Bronze - Sintered - Flanged - Oilite
25.000 +/-0.0254	30.000 +0.0508/+0.0762	40.000 +/-0.127			BP02500-03000-04000-BLG	Bushes - Bronze - Solid - Leaded Gunmetal
25.000 +0.007/+0.028	30.000 +0.035/+0.056	50.000 +/-0.190			BP02500-03000-05000-BSO	Bushes - Bronze - Sintered - Unflanged - Oilite
25.000 +/-0.0254	30.000 +0.0508/+0.0762	50.000 +/-0.127			BP02500-03000-05000-BLG	Bushes - Bronze - Solid - Leaded Gunmetal
25.000 +/-0.0254	30.000 +0.0508/+0.0762	60.000 +/-0.127			BP02500-03000-06000-BLG	Bushes - Bronze - Solid - Leaded Gunmetal
25.000 +/-0.0254	30.000 +0.0508/+0.0762	80.000 +/-0.127			BP02500-03000-08000-BLG	Bushes - Bronze - Solid - Leaded Gunmetal
25.000 +/-0.0254	30.000 +0.0508/+0.0762	100.000 +/-0.127			BP02500-03000-10000-BLG	Bushes - Bronze - Solid - Leaded Gunmetal
25.000 x 32.000 mm (0.984 x 1.260 in.)						
25.000 +0/-0.025	32.000 +0/-0.025	25.000 +/-0.127			BP02500-03200-02500-BS	Bushes - Bronze - Sintered - Unflanged
25.000 +0.007/+0.028	32.000 +0.043/+0.068	25.000 +/-0.160	39.00	3.50	BF02500-03200-02500-BS	Bushes - Bronze - Sintered - Flanged - Oilite
25.000 +0.007/+0.028	32.000 +0.043/+0.068	30.000 +/-0.160	39.00	4.00	BF02500-03200-03000-BSO	Bushes - Bronze - Sintered - Flanged - Oilite
25.000 x 35.000 mm (0.984 x 1.378 in.)						
25.000 +0.007/+0.028	35.000 +0.043/+0.068	25.000 +/-0.160			BP02500-03500-02500-BSO	Bushes - Bronze - Sintered - Unflanged - Oilite
25.000 +/-0.0254	35.000 +0.0508/+0.0762	30.000 +/-0.127			BP02500-03500-03000-BLG	Bushes - Bronze - Solid - Leaded Gunmetal
25.000 +0.007/+0.028	35.000 +0.043/+0.068	35.000 +/-0.190			BP02500-03500-03500-BSO	Bushes - Bronze - Sintered - Unflanged - Oilite
25.000 +/-0.0254	35.000 +0.0508/+0.0762	40.000 +/-0.127			BP02500-03500-04000-BLG	Bushes - Bronze - Solid - Leaded Gunmetal
25.000 +0.007/+0.028	35.000 +0.043/+0.068	50.000 +/-0.190			BP02500-03500-05000-BSO	Bushes - Bronze - Sintered - Unflanged - Oilite
25.000 +/-0.0254	35.000 +0.0508/+0.0762	50.000 +/-0.127			BP02500-03500-05000-BLG	Bushes - Bronze - Solid - Leaded Gunmetal
25.000 +/-0.0254	35.000 +0.0508/+0.0762	60.000 +/-0.127			BP02500-03500-06000-BLG	Bushes - Bronze - Solid - Leaded Gunmetal
25.000 +/-0.0254	35.000 +0.0508/+0.0762	80.000 +/-0.127			BP02500-03500-08000-BLG	Bushes - Bronze - Solid - Leaded Gunmetal
25.000 +/-0.0254	35.000 +0.0508/+0.0762	100.000 +/-0.127			BP02500-03500-10000-BLG	Bushes - Bronze - Solid - Leaded Gunmetal
25.400 x 26.988 mm (1.000 x 1.063 in.)						
25.400 +/-0.0254	26.988 +0.0508/+0.0762	38.100 +/-0.127			BP02540-02699-03810-BLG	Bushes - Bronze - Solid - Leaded Gunmetal
25.400 x 28.575 mm (1.000 x 1.125 in.)						
25.400 -0.025/-0.053	28.575 +0.013/-0.008	9.525 +0.00/-0.30			BP02540-02858-00953-DP4	Bushes - Steel - DP4 - Split - Unflanged
25.400 -0.025/-0.053	28.575 +0.013/-0.008	9.525 +0.00/-0.30			BP02540-02858-00953-DU	Bushes - Steel - DU - Split - Unflanged
25.400 -0.025/-0.053	28.575 +0.013/-0.008	9.525 +0.25/-0.25			BP02540-02858-00953-SS6	Bushes - Stainless Steel and PTFE - Unflanged
25.400 -0.025/-0.053	28.575 +0.013/-0.008	12.700 +0.00/-0.30			BP02540-02858-01270-DU	Bushes - Steel - DU - Split - Unflanged
25.400 -0.025/-0.053	28.575 +0.013/-0.008	12.700 +0.25/-0.25			BP02540-02858-01270-SS6	Bushes - Stainless Steel and PTFE - Unflanged

 Stocked or Short Delivery

 Usually Available

 Long delivery or not in current production

ID	OD	B	DF	bf	Part Number	Type
25.400 x 28.575 mm (1.000 x 1.125 in.)						
25.400 -0.025/-0.053	28.575 +0.013/-0.008	12.700 +0.00/-0.30			BP02540-02858-01270-DP4	Bushes - Steel - DP4 - Split - Unflanged
25.400 -0.025/-0.053	28.575 +0.013/-0.007	12.700 +0.25/-0.25	35.43	1.73	BF02540-02858-01270-DP4	Bushes - Steel - DP4 - Split - Flanged
25.400 -0.025/-0.053	28.575 +0.013/-0.007	12.700 +0.25/-0.25	35.43	1.73	BF02540-02858-01270-DU	Bushes - Steel - DU - Split - Flanged
25.400 -0.025/-0.053	28.575 +0.013/-0.007	12.700 +0.25/-0.25	35.43	1.73	BF02540-02858-01270-SS6	Bushes - Stainless Steel and PTFE - Flanged
25.400 -0.025/-0.053	28.575 +0.013/-0.008	19.050 +0.00/-0.30			BP02540-02858-01905-DU	Bushes - Steel - DU - Split - Unflanged
25.400 +0.076/+0.102	28.575 +0.051/+0.076	19.050 +/-0.127			BP02540-02858-01905-BS	Bushes - Bronze - Sintered - Unflanged
25.400 -0.025/-0.053	28.575 +0.013/-0.008	19.050 +0.00/-0.30			BP02540-02858-01905-DP4	Bushes - Steel - DP4 - Split - Unflanged
25.400 -0.025/-0.053	28.575 +0.013/-0.008	19.050 +0.25/-0.25			BP02540-02858-01905-SS6	Bushes - Stainless Steel and PTFE - Unflanged
25.400 +0.007/+0.028	28.575 +0.035/+0.056	19.050 +/-0.160			BP02540-02858-01905-BSO	Bushes - Bronze - Sintered - Unflanged - Oilite
25.400 -0.025/-0.053	28.575 +0.013/-0.007	19.050 +0.25/-0.25	35.43	1.73	BF02540-02858-01905-DP4	Bushes - Steel - DP4 - Split - Flanged
25.400 -0.025/-0.053	28.575 +0.013/-0.007	19.050 +0.25/-0.25	35.43	1.73	BF02540-02858-01905-DU	Bushes - Steel - DU - Split - Flanged
25.400 -0.025/-0.053	28.575 +0.013/-0.007	19.050 +0.25/-0.25	35.43	1.73	BF02540-02858-01905-SS6	Bushes - Stainless Steel and PTFE - Flanged
25.400 -0.025/-0.053	28.575 +0.013/-0.008	25.400 +0.00/-0.30			BP02540-02858-02540-DU	Bushes - Steel - DU - Split - Unflanged
25.400 -0.025/-0.053	28.575 +0.013/-0.008	25.400 +0.00/-0.30			BP02540-02858-02540-DP4	Bushes - Steel - DP4 - Split - Unflanged
25.400 -0.025/-0.053	28.575 +0.013/-0.008	25.400 +0.25/-0.25			BP02540-02858-02540-SS6	Bushes - Stainless Steel and PTFE - Unflanged
25.400 +0.007/+0.028	28.575 +0.035/+0.056	25.400 +/-0.160			BP02540-02858-02540-BSO	Bushes - Bronze - Sintered - Unflanged - Oilite
25.400 +/-0.0254	28.575 +0.0508/+0.0762	25.400 +/-0.127			BP02540-02858-02540-BC9	Bushes - Bronze - Solid - Leaded Gunmetal
25.400 +/-0.0254	28.575 +0.0508/+0.0762	25.400 +/-0.127			BP02540-02858-02540-BLG	Bushes - Bronze - Solid - Leaded Gunmetal
25.400 -0.025/-0.053	28.575 +0.013/-0.007	25.400 +0.25/-0.25	35.43	1.73	BF02540-02858-02540-SS6	Bushes - Stainless Steel and PTFE - Flanged
25.400 -0.025/-0.053	28.575 +0.013/-0.007	25.400 +0.25/-0.25	35.43	1.73	BF02540-02858-02540-DU	Bushes - Steel - DU - Split - Flanged
25.400 -0.025/-0.053	28.575 +0.013/-0.007	25.400 +0.25/-0.25	35.43	1.73	BF02540-02858-02540-DP4	Bushes - Steel - DP4 - Split - Flanged
25.400 -0.025/-0.053	28.575 +0.013/-0.008	31.750 +0.00/-0.30			BP02540-02858-03175-DU	Bushes - Steel - DU - Split - Unflanged
25.400 +0.007/+0.028	28.575 +0.035/+0.056	31.750 +/-0.190			BP02540-02858-03175-BSO	Bushes - Bronze - Sintered - Unflanged - Oilite
25.400 -0.025/-0.053	28.575 +0.013/-0.008	31.750 +0.00/-0.30			BP02540-02858-03175-DP4	Bushes - Steel - DP4 - Split - Unflanged
25.400 -0.025/-0.053	28.575 +0.013/-0.008	31.750 +0.25/-0.25			BP02540-02858-03175-SS6	Bushes - Stainless Steel and PTFE - Unflanged
25.400 +/-0.0254	28.575 +0.0508/+0.0762	31.750 +/-0.127			BP02540-02858-03175-BLG	Bushes - Bronze - Solid - Leaded Gunmetal
25.400 -0.025/-0.053	28.575 +0.013/-0.007	31.750 +0.25/-0.25	35.43	1.73	BF02540-02858-03175-SS6	Bushes - Stainless Steel and PTFE - Flanged
25.400 -0.025/-0.053	28.575 +0.013/-0.007	31.750 +0.25/-0.25	35.43	1.73	BF02540-02858-03175-DP4	Bushes - Steel - DP4 - Split - Flanged
25.400 -0.025/-0.053	28.575 +0.013/-0.007	31.750 +0.25/-0.25	35.43	1.73	BF02540-02858-03175-DU	Bushes - Steel - DU - Split - Flanged
25.400 +0/+0.025	28.575 +0.051/+0.076	38.100 +/-0.127			BP02540-02858-03810-BS	Bushes - Bronze - Sintered - Unflanged
25.400 -0.025/-0.053	28.575 +0.013/-0.008	38.100 +0.25/-0.25			BP02540-02858-03810-SS6	Bushes - Stainless Steel and PTFE - Unflanged
25.400 +0.007/+0.028	28.575 +0.035/+0.056	38.100 +/-0.190			BP02540-02858-03810-BSO	Bushes - Bronze - Sintered - Unflanged - Oilite
25.400 -0.025/-0.053	28.575 +0.013/-0.008	38.100 +0.00/-0.30			BP02540-02858-03810-DP4	Bushes - Steel - DP4 - Split - Unflanged
25.400 -0.025/-0.053	28.575 +0.013/-0.008	38.100 +0.00/-0.30			BP02540-02858-03810-DU	Bushes - Steel - DU - Split - Unflanged
25.400 +/-0.0254	28.575 +0.0508/+0.0762	38.100 +/-0.127			BP02540-02858-03810-BC9	Bushes - Bronze - Solid - Leaded Gunmetal
25.400 +/-0.0254	28.575 +0.0508/+0.0762	38.100 +/-0.127			BP02540-02858-03810-BLG	Bushes - Bronze - Solid - Leaded Gunmetal
25.400 +/-0.0254	28.575 +0.0508/+0.0762	50.800 +/-0.127			BP02540-02858-05080-BLG	Bushes - Bronze - Solid - Leaded Gunmetal
25.400 +/-0.0254	28.575 +0.0508/+0.0762	63.500 +/-0.127			BP02540-02858-06350-BLG	Bushes - Bronze - Solid - Leaded Gunmetal
25.400 +/-0.0254	28.575 +0.0508/+0.0762	76.200 +/-0.127			BP02540-02858-07620-BLG	Bushes - Bronze - Solid - Leaded Gunmetal
25.400 x 30.163 mm (1.000 x 1.188 in.)						
25.400 +0.076/+0.102	30.163 +0.039/+0.064	19.050 +/-0.127			BP02540-03016-01905-BS	Bushes - Bronze - Sintered - Unflanged

 Stocked or Short Delivery

 Usually Available

 Long delivery or not in current production

ID	OD	B	DF	bf	Part Number	Type
25.400 x 30.163 mm (1.000 x 1.188 in.)						
25.400 +0.076/+0.102	30.163 +0.039/+0.064	25.400 +/-0.127			BP02540-03016-02540-BS	Bushes - Bronze - Sintered - Unflanged
25.400 +/-0.0254	30.163 +0.0508/+0.0762	38.100 +/-0.127			BP02540-03016-03810-BLG	Bushes - Bronze - Solid - Leaded Gunmetal
25.400 +/-0.0254	30.163 +0.0508/+0.0762	50.800 +/-0.127			BP02540-03016-05080-BLG	Bushes - Bronze - Solid - Leaded Gunmetal
25.400 +/-0.0254	30.163 +0.0508/+0.0762	63.500 +/-0.127			BP02540-03016-06350-BLG	Bushes - Bronze - Solid - Leaded Gunmetal
25.400 x 31.750 mm (1.000 x 1.250 in.)						
25.400 +0.076/+0.102	31.750 +0.077/+0.102	12.700 +/-0.127			BP02540-03175-01270-BS	Bushes - Bronze - Sintered - Unflanged
25.400 +0.076/+0.102	31.750 +0.077/+0.102	19.050 +/-0.127			BP02540-03175-01905-BS	Bushes - Bronze - Sintered - Unflanged
25.400 +0.007/+0.028	31.750 +0.043/+0.068	19.050 +/-0.160			BP02540-03175-01905-BSO	Bushes - Bronze - Sintered - Unflanged - Oilite
25.400 +/-0.0254	31.750 +0.0508/+0.0762	19.050 +/-0.127			BP02540-03175-01905-BC9	Bushes - Bronze - Solid - Leaded Gunmetal
25.400 +0.025/+0.050	31.750 +0.051/+0.076	19.050 +/-0.127	38.10	4.76	BF02540-03175-01905-BS	Bushes - Bronze - Sintered - Flanged
25.400 +0.007/+0.028	31.750 +0.043/+0.068	22.225 +/-0.160			BP02540-03175-02223-BSO	Bushes - Bronze - Sintered - Unflanged - Oilite
25.400 +0.076/+0.102	31.750 +0.077/+0.102	25.400 +/-0.127			BP02540-03175-02540-BS	Bushes - Bronze - Sintered - Unflanged
25.400 +0.007/+0.028	31.750 +0.043/+0.068	25.400 +/-0.160			BP02540-03175-02540-BSO	Bushes - Bronze - Sintered - Unflanged - Oilite
25.400 +/-0.0254	31.750 +0.0508/+0.0762	25.400 +/-0.127			BP02540-03175-02540-BC9	Bushes - Bronze - Solid - Leaded Gunmetal
25.400 +/-0.0254	31.750 +0.0508/+0.0762	25.400 +/-0.127			BP02540-03175-02540-BLG	Bushes - Bronze - Solid - Leaded Gunmetal
25.400 +0.007/+0.028	31.750 +0.043/+0.068	25.400 +/-0.160	38.10	3.18	BF02540-03175-02540-BSO	Bushes - Bronze - Sintered - Flanged - Oilite
25.400 +0.025/+0.050	31.750 +0.051/+0.076	25.400 +/-0.127	38.10	4.76	BF02540-03175-02540-BS	Bushes - Bronze - Sintered - Flanged
25.400 +0.007/+0.028	31.750 +0.043/+0.068	28.575 +/-0.160			BP02540-03175-02858-BSO	Bushes - Bronze - Sintered - Unflanged - Oilite
25.400 +/-0.0254	31.750 +0.0508/+0.0762	28.580 +/-0.127			BP02540-03175-02858-BLG	Bushes - Bronze - Solid - Leaded Gunmetal
25.400 +0/+0.025	31.750 +0.026/+0.051	31.750 +/-0.127			BP02540-03175-03175-BS02	Bushes - Bronze - Sintered - Unflanged
25.400 +0.076/+0.102	31.750 +0.077/+0.102	31.750 +/-0.127			BP02540-03175-03175-BS10	Bushes - Bronze - Sintered - Unflanged
25.400 +0.007/+0.028	31.750 +0.043/+0.068	31.750 +/-0.190			BP02540-03175-03175-BSO	Bushes - Bronze - Sintered - Unflanged - Oilite
25.400 +/-0.0254	31.750 +0.0508/+0.0762	31.750 +/-0.127			BP02540-03175-03175-BC9	Bushes - Bronze - Solid - Leaded Gunmetal
25.400 +/-0.0254	31.750 +0.0508/+0.0762	31.750 +/-0.127			BP02540-03175-03175-BLG	Bushes - Bronze - Solid - Leaded Gunmetal
25.400 +0.025/+0.050	31.750 +0.051/+0.076	31.750 +/-0.127	38.10	4.76	BF02540-03175-03175-BS	Bushes - Bronze - Sintered - Flanged
25.400 +0.007/+0.028	31.750 +0.043/+0.068	34.925 +/-0.190			BP02540-03175-03493-BSO	Bushes - Bronze - Sintered - Unflanged - Oilite
25.400 +0/+0.025	31.750 +0.026/+0.051	38.100 +/-0.127			BP02540-03175-03810-BS02	Bushes - Bronze - Sintered - Unflanged
25.400 +0.076/+0.102	31.750 +0.077/+0.102	38.100 +/-0.127			BP02540-03175-03810-BS10	Bushes - Bronze - Sintered - Unflanged
25.400 +0.007/+0.028	31.750 +0.043/+0.068	38.100 +/-0.190			BP02540-03175-03810-BSO	Bushes - Bronze - Sintered - Unflanged - Oilite
25.400 +/-0.0254	31.750 +0.0508/+0.0762	38.100 +/-0.127			BP02540-03175-03810-BC9	Bushes - Bronze - Solid - Leaded Gunmetal
25.400 +/-0.0254	31.750 +0.0508/+0.0762	38.100 +/-0.127			BP02540-03175-03810-BLG	Bushes - Bronze - Solid - Leaded Gunmetal
25.400 +0/-0.025	31.750 +0.026/+0.051	38.100 +/-0.127	38.10	3.18	BF02540-03175-03810-BS00	Bushes - Bronze - Sintered - Flanged
25.400 +0.007/+0.028	31.750 +0.043/+0.068	38.100 +/-0.190	38.10	3.18	BF02540-03175-03810-BSO	Bushes - Bronze - Sintered - Flanged - Oilite
25.400 +0.025/+0.050	31.750 +0.051/+0.076	38.100 +/-0.127	38.10	4.76	BF02540-03175-03810-BS05	Bushes - Bronze - Sintered - Flanged
25.400 +0.007/+0.028	31.750 +0.043/+0.068	41.275 +/-0.190			BP02540-03175-04128-BSO	Bushes - Bronze - Sintered - Unflanged - Oilite
25.400 +0.076/+0.102	31.750 +0.077/+0.102	44.450 +/-0.190			BP02540-03175-04445-BS	Bushes - Bronze - Sintered - Unflanged
25.400 +0.007/+0.028	31.750 +0.043/+0.068	44.450 +/-0.190			BP02540-03175-04445-BSO	Bushes - Bronze - Sintered - Unflanged - Oilite
25.400 +/-0.0254	31.750 +0.0508/+0.0762	44.450 +/-0.127			BP02540-03175-04445-BC9	Bushes - Bronze - Solid - Leaded Gunmetal
25.400 +/-0.0254	31.750 +0.0508/+0.0762	44.450 +/-0.127			BP02540-03175-04445-BLG	Bushes - Bronze - Solid - Leaded Gunmetal
25.400 +0.025/+0.051	31.750 +0.026/+0.051	44.450 +/-0.190	41.28	3.18	BF02540-03175-04445-BS	Bushes - Bronze - Sintered - Flanged
25.400 +0.076/+0.102	31.750 +0.077/+0.102	50.800 +/-0.190			BP02540-03175-05080-BS	Bushes - Bronze - Sintered - Unflanged

 Stocked or Short Delivery

 Usually Available

 Long delivery or not in current production

ID	OD	B	DF	bf	Part Number	Type
25.400 x 31.750 mm (1.000 x 1.250 in.)						
25.400 +0.007/+0.028	31.750 +0.043/+0.068	50.800 +/-0.250			BP02540-03175-05080-BSO	Bushes - Bronze - Sintered - Unflanged - Oilite
25.400 +/-0.0254	31.750 +0.0508/+0.0762	50.800 +/-0.127			BP02540-03175-05080-BC9	Bushes - Bronze - Solid - Leaded Gunmetal
25.400 +/-0.0254	31.750 +0.0508/+0.0762	50.800 +/-0.127			BP02540-03175-05080-BLG	Bushes - Bronze - Solid - Leaded Gunmetal
25.400 +0.025/+0.050	31.750 +0.051/+0.076	50.800 +/-0.127	38.10	4.76	BF02540-03175-05080-BS	Bushes - Bronze - Sintered - Flanged
25.400 +0.076/+0.102	31.750 +0.077/+0.102	63.500 +/-0.190			BP02540-03175-06350-BS	Bushes - Bronze - Sintered - Unflanged
25.400 +/-0.0254	31.750 +0.0508/+0.0762	63.500 +/-0.127			BP02540-03175-06350-BC9	Bushes - Bronze - Solid - Leaded Gunmetal
25.400 +/-0.0254	31.750 +0.0508/+0.0762	63.500 +/-0.127			BP02540-03175-06350-BLG	Bushes - Bronze - Solid - Leaded Gunmetal
25.400 +/-0.0254	31.750 +0.0508/+0.0762	76.200 +/-0.127			BP02540-03175-07620-BC9	Bushes - Bronze - Solid - Leaded Gunmetal
25.400 +/-0.0254	31.750 +0.0508/+0.0762	76.200 +/-0.127			BP02540-03175-07620-BLG	Bushes - Bronze - Solid - Leaded Gunmetal
25.400 +/-0.0254	31.750 +0.0508/+0.0762	88.900 +/-0.127			BP02540-03175-08890-BLG	Bushes - Bronze - Solid - Leaded Gunmetal
25.400 +/-0.0254	31.750 +0.0508/+0.0762	101.600 +/-0.127			BP02540-03175-10160-BLG	Bushes - Bronze - Solid - Leaded Gunmetal
25.400 x 31.800 mm (1.000 x 1.252 in.)						
25.400 +0.0254/+0.0508	31.800 +0.0508/+0.0762	12.700 +0.127/-0.127			BP02540-03180-01270-BFG	Bushes - Bronze - Sintered - ECO841 Food Grade - Unflanged
25.400 +0.0254/+0.0508	31.800 +0.0508/+0.0762	19.050 +0.127/-0.127			BP02540-03180-01905-BFG	Bushes - Bronze - Sintered - ECO841 Food Grade - Unflanged
25.400 +0.0254/+0.0508	31.800 +0.0508/+0.0762	25.400 +0.127/-0.127			BP02540-03180-02540-BFG	Bushes - Bronze - Sintered - ECO841 Food Grade - Unflanged
25.400 +0.0254/+0.0508	31.800 +0.0508/+0.0762	31.750 +0.127/-0.127			BP02540-03180-03175-BFG	Bushes - Bronze - Sintered - ECO841 Food Grade - Unflanged
25.400 +0.0254/+0.0508	31.800 +0.0508/+0.0762	38.100 +0.190/-0.190			BP02540-03180-03810-BFG	Bushes - Bronze - Sintered - ECO841 Food Grade - Unflanged
25.400 x 33.338 mm (1.000 x 1.313 in.)						
25.400 +0.076/+0.102	33.338 +0.064/+0.089	25.400 +/-0.127			BP02540-03334-02540-BS	Bushes - Bronze - Sintered - Unflanged
25.400 +0.076/+0.102	33.338 +0.064/+0.089	31.750 +/-0.127			BP02540-03334-03175-BS	Bushes - Bronze - Sintered - Unflanged
25.400 +0.076/+0.102	33.338 +0.064/+0.089	38.100 +/-0.127			BP02540-03334-03810-BS	Bushes - Bronze - Sintered - Unflanged
25.400 +0.076/+0.102	33.338 +0.064/+0.089	44.450 +/-0.190			BP02540-03334-04445-BS	Bushes - Bronze - Sintered - Unflanged
25.400 +0.076/+0.102	33.338 +0.064/+0.089	50.800 +/-0.190			BP02540-03334-05080-BS	Bushes - Bronze - Sintered - Unflanged
25.400 +0.076/+0.102	33.338 +0.064/+0.089	63.500 +/-0.190			BP02540-03334-06350-BS	Bushes - Bronze - Sintered - Unflanged
25.400 +0.076/+0.102	33.338 +0.064/+0.089	76.200 +/-0.190			BP02540-03334-07620-BS	Bushes - Bronze - Sintered - Unflanged
25.400 x 34.925 mm (1.000 x 1.375 in.)						
25.400 +0.076/+0.102	34.925 +0.077/+0.102	19.050 +/-0.127			BP02540-03493-01905-BS	Bushes - Bronze - Sintered - Unflanged
25.400 +0.013/-0.000	34.925 +0.013/-0.000	22.225 +0.00/-1.52	39.37	4.76	BF02540-03493-02223-BAG	Bushes - Aluminium Bronze - Graphite Plug - Flanged
25.400 +0.013/-0.000	34.925 +0.013/-0.000	22.225 +0.00/-1.52	39.37	4.76	BF02540-03493-02223-BA	Bushes - Aluminium Bronze - Flanged
25.400 +0.076/+0.102	34.925 +0.077/+0.102	25.400 +/-0.127			BP02540-03493-02540-BS	Bushes - Bronze - Sintered - Unflanged
25.400 +/-0.0254	34.925 +0.0508/+0.0762	25.400 +/-0.127			BP02540-03493-02540-BC9	Bushes - Bronze - Solid - Leaded Gunmetal
25.400 +0.025/+0.050	34.925 +0.051/+0.076	25.400 +/-0.127	41.28	4.76	BF02540-03493-02540-BS	Bushes - Bronze - Sintered - Flanged
25.400 +0.013/-0.000	34.925 +0.013/-0.000	31.750 +0.00/-1.52			BP02540-03493-03175-BA	Bushes - Aluminium Bronze - Unflanged
25.400 +0.076/+0.102	34.925 +0.077/+0.102	31.750 +/-0.127			BP02540-03493-03175-BS	Bushes - Bronze - Sintered - Unflanged
25.400 +0.013/-0.000	34.925 +0.013/-0.000	31.750 +0.00/-1.52			BP02540-03493-03175-BAG	Bushes - Aluminium Bronze - Graphite Plug - Unflanged
25.400 +0.013/-0.000	34.925 +0.013/-0.000	34.925 +0.00/-1.52			BP02540-03493-03493-BA	Bushes - Aluminium Bronze - Unflanged
25.400 +0.013/-0.000	34.925 +0.013/-0.000	34.925 +0.00/-1.52			BP02540-03493-03493-BAG	Bushes - Aluminium Bronze - Graphite Plug - Unflanged
25.400 +0.013/-0.000	34.925 +0.013/-0.000	34.925 +0.00/-1.52	39.37	4.76	BF02540-03493-03493-BAG	Bushes - Aluminium Bronze - Graphite Plug - Flanged

 Stocked or Short Delivery

 Usually Available

 Long delivery or not in current production

ID	OD	B	DF	bf	Part Number	Type
----	----	---	----	----	-------------	------

25.400 x 34.925 mm (1.000 x 1.375 in.)						
25.400 +0.013/-0.000	34.925 +0.013/-0.000	34.925 +0.00/-1.52	39.37	4.76	BF02540-03493-03493-BA	Bushes - Aluminium Bronze - Flanged
25.400 +0.076/+0.102	34.925 +0.077/+0.102	38.100 +/-0.127			BP02540-03493-03810-BS	Bushes - Bronze - Sintered - Unflanged
25.400 +0.013/-0.000	34.925 +0.013/-0.000	38.100 +0.00/-1.52			BP02540-03493-03810-BA	Bushes - Aluminium Bronze - Unflanged
25.400 +0.013/-0.000	34.925 +0.013/-0.000	38.100 +0.00/-1.52			BP02540-03493-03810-BAG	Bushes - Aluminium Bronze - Graphite Plug - Unflanged
25.400 +/-0.0254	34.925 +0.0508/+0.0762	38.100 +/-0.127			BP02540-03493-03810-BC9	Bushes - Bronze - Solid - Leaded Gunmetal
25.400 +/-0.0254	34.925 +0.0508/+0.0762	38.100 +/-0.127			BP02540-03493-03810-BLG	Bushes - Bronze - Solid - Leaded Gunmetal
25.400 +0.013/-0.000	34.925 +0.013/-0.000	44.450 +0.00/-1.52			BP02540-03493-04445-BAG	Bushes - Aluminium Bronze - Graphite Plug - Unflanged
25.400 +0.076/+0.102	34.925 +0.077/+0.102	44.450 +/-0.190			BP02540-03493-04445-BS	Bushes - Bronze - Sintered - Unflanged
25.400 +0.013/-0.000	34.925 +0.013/-0.000	44.450 +0.00/-1.52			BP02540-03493-04445-BA	Bushes - Aluminium Bronze - Unflanged
25.400 +0.025/+0.050	34.925 +0.051/+0.076	44.450 +/-0.190	41.28	4.76	BF02540-03493-04445-BS	Bushes - Bronze - Sintered - Flanged
25.400 +0.013/-0.000	34.925 +0.013/-0.000	47.625 +0.00/-1.52	39.37	4.76	BF02540-03493-04763-BA	Bushes - Aluminium Bronze - Flanged
25.400 +0.013/-0.000	34.925 +0.013/-0.000	47.625 +0.00/-1.52	39.37	4.76	BF02540-03493-04763-BAG	Bushes - Aluminium Bronze - Graphite Plug - Flanged
25.400 +0.076/+0.102	34.925 +0.077/+0.102	50.800 +/-0.190			BP02540-03493-05080-BS	Bushes - Bronze - Sintered - Unflanged
25.400 +0.013/-0.000	34.925 +0.013/-0.000	50.800 +0.00/-1.52			BP02540-03493-05080-BA	Bushes - Aluminium Bronze - Unflanged
25.400 +0.013/-0.000	34.925 +0.013/-0.000	50.800 +0.00/-1.52			BP02540-03493-05080-BAG	Bushes - Aluminium Bronze - Graphite Plug - Unflanged
25.400 +/-0.0254	34.925 +0.0508/+0.0762	50.800 +/-0.127			BP02540-03493-05080-BLG	Bushes - Bronze - Solid - Leaded Gunmetal
25.400 +0.013/-0.000	34.925 +0.013/-0.000	60.325 +0.00/-1.52	39.37	4.76	BF02540-03493-06033-BA	Bushes - Aluminium Bronze - Flanged
25.400 +0.013/-0.000	34.925 +0.013/-0.000	60.325 +0.00/-1.52	39.37	4.76	BF02540-03493-06033-BAG	Bushes - Aluminium Bronze - Graphite Plug - Flanged
25.400 +0.076/+0.102	34.925 +0.077/+0.102	63.500 +/-0.190			BP02540-03493-06350-BS	Bushes - Bronze - Sintered - Unflanged
25.400 +/-0.0254	34.925 +0.0508/+0.0762	63.500 +/-0.127			BP02540-03493-06350-BLG	Bushes - Bronze - Solid - Leaded Gunmetal
25.400 +0.013/-0.000	34.925 +0.013/-0.000	73.025 +0.00/-1.52	39.37	4.76	BF02540-03493-07303-BAG	Bushes - Aluminium Bronze - Graphite Plug - Flanged
25.400 +0.013/-0.000	34.925 +0.013/-0.000	73.025 +0.00/-1.52	39.37	4.76	BF02540-03493-07303-BA	Bushes - Aluminium Bronze - Flanged
25.400 +0.013/-0.000	34.925 +0.013/-0.000	76.200 +0.00/-1.52			BP02540-03493-07620-BA	Bushes - Aluminium Bronze - Unflanged
25.400 +0.013/-0.000	34.925 +0.013/-0.000	76.200 +0.00/-1.52			BP02540-03493-07620-BAG	Bushes - Aluminium Bronze - Graphite Plug - Unflanged
25.400 +/-0.0254	34.925 +0.0508/+0.0762	76.200 +/-0.127			BP02540-03493-07620-BLG	Bushes - Bronze - Solid - Leaded Gunmetal
25.400 +0.013/-0.000	34.925 +0.013/-0.000	85.725 +0.00/-1.52	39.37	4.76	BF02540-03493-08573-BA	Bushes - Aluminium Bronze - Flanged
25.400 +0.013/-0.000	34.925 +0.013/-0.000	85.725 +0.00/-1.52	39.37	4.76	BF02540-03493-08573-BAG	Bushes - Aluminium Bronze - Graphite Plug - Flanged
25.400 +0.013/-0.000	34.925 +0.013/-0.000	98.425 +0.00/-1.52	39.37	4.76	BF02540-03493-09843-BA	Bushes - Aluminium Bronze - Flanged
25.400 +0.013/-0.000	34.925 +0.013/-0.000	98.425 +0.00/-1.52	39.37	4.76	BF02540-03493-09843-BAG	Bushes - Aluminium Bronze - Graphite Plug - Flanged
25.400 +0.013/-0.000	34.925 +0.013/-0.000	111.125 +0.00/-1.52	39.37	4.76	BF02540-03493-11113-BA	Bushes - Aluminium Bronze - Flanged
25.400 +0.013/-0.000	34.925 +0.013/-0.000	111.125 +0.00/-1.52	39.37	4.76	BF02540-03493-11113-BAG	Bushes - Aluminium Bronze - Graphite Plug - Flanged
25.400 +0.013/-0.000	34.925 +0.013/-0.000	123.825 +0.00/-1.52	39.37	4.76	BF02540-03493-12383-BA	Bushes - Aluminium Bronze - Flanged
25.400 +0.013/-0.000	34.925 +0.013/-0.000	123.825 +0.00/-1.52	39.37	4.76	BF02540-03493-12383-BAG	Bushes - Aluminium Bronze - Graphite Plug - Flanged
25.400 +0.013/-0.000	34.925 +0.013/-0.000	149.225 +0.00/-1.52	39.37	4.76	BF02540-03493-14923-BA	Bushes - Aluminium Bronze - Flanged
25.400 +0.013/-0.000	34.925 +0.013/-0.000	149.225 +0.00/-1.52	39.37	4.76	BF02540-03493-14923-BAG	Bushes - Aluminium Bronze - Graphite Plug - Flanged

25.400 x 38.100 mm (1.000 x 1.500 in.)						
25.400 +0.076/+0.102	38.100 +0.077/+0.102	25.400 +/-0.127			BP02540-03810-02540-BS	Bushes - Bronze - Sintered - Unflanged
25.400 +0.076/+0.102	38.100 +0.077/+0.102	31.750 +/-0.127			BP02540-03810-03175-BS	Bushes - Bronze - Sintered - Unflanged
25.400 +0.076/+0.102	38.100 +0.077/+0.102	38.100 +/-0.127			BP02540-03810-03810-BS	Bushes - Bronze - Sintered - Unflanged
25.400 +/-0.0254	38.100 +0.0508/+0.0762	38.100 +/-0.127			BP02540-03810-03810-BC9	Bushes - Bronze - Solid - Leaded Gunmetal
25.400 +0.076/+0.102	38.100 +0.077/+0.102	44.450 +/-0.190			BP02540-03810-04445-BS	Bushes - Bronze - Sintered - Unflanged

 Stocked or Short Delivery

 Usually Available

 Long delivery or not in current production

ID	OD	B	DF	bf	Part Number	Type
25.400 x 38.100 mm (1.000 x 1.500 in.)						
25.400 +0.076/+0.102	38.100 +0.077/+0.102	50.800 +/-0.190			BP02540-03810-05080-BS	Bushes - Bronze - Sintered - Unflanged
25.400 +/-0.0254	38.100 +0.0508/+0.0762	50.800 +/-0.127			BP02540-03810-05080-BC9	Bushes - Bronze - Solid - Leaded Gunmetal
25.400 +0.076/+0.102	38.100 +0.077/+0.102	63.500 +/-0.190			BP02540-03810-06350-BS	Bushes - Bronze - Sintered - Unflanged
25.400 +0.076/+0.102	38.100 +0.077/+0.102	76.200 +/-0.190			BP02540-03810-07620-BS	Bushes - Bronze - Sintered - Unflanged
25.400 +/-0.0254	38.100 +0.0508/+0.0762	76.200 +/-0.127			BP02540-03810-07620-BC9	Bushes - Bronze - Solid - Leaded Gunmetal
25.400 +/-0.0254	38.100 +0.0508/+0.0762	101.600 +/-0.127			BP02540-03810-10160-BC9	Bushes - Bronze - Solid - Leaded Gunmetal
26.988 x 33.338 mm (1.063 x 1.313 in.)						
26.988 +0.076/+0.102	33.338 +0.064/+0.089	25.400 +/-0.127			BP02699-03334-02540-BS10	Bushes - Bronze - Sintered - Unflanged
26.988 +0.013/+0.038	33.338 +0.090/+0.115	25.400 +/-0.127			BP02699-03334-02540-BS04	Bushes - Bronze - Sintered - Unflanged
26.988 +0.013/+0.038	33.338 +0.090/+0.115	31.750 +/-0.127			BP02699-03334-03175-BS	Bushes - Bronze - Sintered - Unflanged
26.988 +0.076/+0.102	33.338 +0.064/+0.089	38.100 +/-0.127			BP02699-03334-03810-BS	Bushes - Bronze - Sintered - Unflanged
26.988 +0.076/+0.102	33.338 +0.064/+0.089	50.800 +/-0.190			BP02699-03334-05080-BS	Bushes - Bronze - Sintered - Unflanged
26.988 +0.076/+0.102	33.338 +0.064/+0.089	63.500 +/-0.190			BP02699-03334-06350-BS	Bushes - Bronze - Sintered - Unflanged
28.000 x 31.000 mm (1.102 x 1.220 in.)						
28.000 -0.000/-0.041	31.000 +0.085/-0.000	30.000 +0.25/-0.25			BP02800-03100-03000-DX	Bushes - Steel - DX - Split - Unflanged
28.000 x 32.000 mm (1.102 x 1.260 in.)						
28.000 -0.000/-0.021	32.000 +0.025/-0.000	15.000 +0.25/-0.25			BP02800-03200-01500-DP4	Bushes - Steel - DP4 - Split - Unflanged
28.000 -0.000/-0.041	32.000 +0.085/-0.000	15.000 +0.00/-0.30			BP02800-03200-01500-DU	Bushes - Steel - DU - Split - Unflanged
28.000 -0.000/-0.041	32.000 +0.085/-0.000	15.000 +0.00/-0.30			BP02800-03200-01500-SS6	Bushes - Stainless Steel and PTFE - Unflanged
28.000 -0.000/-0.021	32.000 +0.025/-0.000	20.000 +0.25/-0.25			BP02800-03200-02000-DP4	Bushes - Steel - DP4 - Split - Unflanged
28.000 -0.000/-0.041	32.000 +0.085/-0.000	20.000 +0.00/-0.30			BP02800-03200-02000-DU	Bushes - Steel - DU - Split - Unflanged
28.000 -0.000/-0.041	32.000 +0.085/-0.000	20.000 +0.00/-0.30			BP02800-03200-02000-SS6	Bushes - Stainless Steel and PTFE - Unflanged
28.000 -0.000/-0.041	32.000 +0.085/-0.000	20.000 +0.25/-0.25			BP02800-03200-02000-DX	Bushes - Steel - DX - Split - Unflanged
28.000 -0.000/-0.041	32.000 +0.085/-0.000	25.000 +0.00/-0.30			BP02800-03200-02500-SS6	Bushes - Stainless Steel and PTFE - Unflanged
28.000 -0.000/-0.041	32.000 +0.085/-0.000	25.000 +0.00/-0.30			BP02800-03200-02500-DU	Bushes - Steel - DU - Split - Unflanged
28.000 -0.000/-0.021	32.000 +0.025/-0.000	25.000 +0.25/-0.25			BP02800-03200-02500-DP4	Bushes - Steel - DP4 - Split - Unflanged
28.000 -0.000/-0.041	32.000 +0.085/-0.000	30.000 +0.00/-0.30			BP02800-03200-03000-DU	Bushes - Steel - DU - Split - Unflanged
28.000 -0.000/-0.041	32.000 +0.085/-0.000	30.000 +0.00/-0.30			BP02800-03200-03000-SS6	Bushes - Stainless Steel and PTFE - Unflanged
28.000 -0.000/-0.021	32.000 +0.025/-0.000	30.000 +0.25/-0.25			BP02800-03200-03000-DP4	Bushes - Steel - DP4 - Split - Unflanged
28.000 -0.000/-0.041	32.000 +0.085/-0.000	30.000 +0.25/-0.25			BP02800-03200-03000-DUB	Bushes - Steel - DUB - Split - Unflanged
28.000 -0.000/-0.041	32.000 +0.085/-0.000	30.000 +0.25/-0.25			BP02800-03200-03000-DX	Bushes - Steel - DX - Split - Unflanged
28.000 -0.000/-0.041	32.000 +0.085/-0.000	40.000 +0.00/-0.30			BP02800-03200-04000-DU	Bushes - Steel - DU - Split - Unflanged
28.000 -0.000/-0.041	32.000 +0.085/-0.000	40.000 +0.00/-0.30			BP02800-03200-04000-SS6	Bushes - Stainless Steel and PTFE - Unflanged
28.000 -0.000/-0.021	32.000 +0.025/-0.000	40.000 +0.25/-0.25			BP02800-03200-04000-DP4	Bushes - Steel - DP4 - Split - Unflanged
28.575 x 31.750 mm (1.125 x 1.250 in.)						
28.575 -0.025/-0.061	31.750 +0.014/-0.027	9.525 +0.00/-0.30			BP02858-03175-00953-DU	Bushes - Steel - DU - Split - Unflanged
28.575 -0.025/-0.061	31.750 +0.014/-0.027	9.525 +0.25/-0.25			BP02858-03175-00953-SS6	Bushes - Stainless Steel and PTFE - Unflanged
28.575 -0.025/-0.061	31.750 +0.014/-0.027	9.525 +0.00/-0.30			BP02858-03175-00953-DP4	Bushes - Steel - DP4 - Split - Unflanged
28.575 -0.025/-0.061	31.750 +0.014/-0.027	15.875 +0.25/-0.25			BP02858-03175-01588-SS6	Bushes - Stainless Steel and PTFE - Unflanged
28.575 -0.025/-0.061	31.750 +0.014/-0.027	15.875 +0.00/-0.30			BP02858-03175-01588-DP4	Bushes - Steel - DP4 - Split - Unflanged

 Stocked or Short Delivery

 Usually Available

 Long delivery or not in current production

ID	OD	B	DF	bf	Part Number	Type
----	----	---	----	----	-------------	------

28.575 x 31.750 mm (1.125 x 1.250 in.)						
28.575 -0.025/-0.061	31.750 +0.014/-0.027	15.875 +0.00/-0.30			BP02858-03175-01588-DU	Bushes - Steel - DU - Split - Unflanged
28.575 -0.025/-0.061	31.750 +0.014/-0.027	19.050 +0.25/-0.25			BP02858-03175-01905-SS6	Bushes - Stainless Steel and PTFE - Unflanged
28.575 -0.025/-0.061	31.750 +0.014/-0.027	19.050 +0.00/-0.30			BP02858-03175-01905-DP4	Bushes - Steel - DP4 - Split - Unflanged
28.575 -0.025/-0.061	31.750 +0.014/-0.027	19.050 +0.00/-0.30			BP02858-03175-01905-DU	Bushes - Steel - DU - Split - Unflanged
28.575 +0.076/+0.102	31.750 +0.077/+0.102	25.400 +/-0.127			BP02858-03175-02540-BS	Bushes - Bronze - Sintered - Unflanged
28.575 -0.025/-0.061	31.750 +0.014/-0.027	25.400 +0.00/-0.30			BP02858-03175-02540-DP4	Bushes - Steel - DP4 - Split - Unflanged
28.575 -0.025/-0.061	31.750 +0.014/-0.027	25.400 +0.00/-0.30			BP02858-03175-02540-DU	Bushes - Steel - DU - Split - Unflanged
28.575 -0.025/-0.061	31.750 +0.014/-0.027	25.400 +0.25/-0.25			BP02858-03175-02540-SS6	Bushes - Stainless Steel and PTFE - Unflanged
28.575 +0.076/+0.102	31.750 +0.077/+0.102	31.750 +/-0.127			BP02858-03175-03175-BS	Bushes - Bronze - Sintered - Unflanged
28.575 +/-0.0254	31.750 +0.0508/+0.0762	31.750 +/-0.127			BP02858-03175-03175-BLG	Bushes - Bronze - Solid - Leaded Gunmetal
28.575 +0.076/+0.102	31.750 +0.077/+0.102	38.100 +/-0.127			BP02858-03175-03810-BS	Bushes - Bronze - Sintered - Unflanged
28.575 +/-0.0254	31.750 +0.0508/+0.0762	44.450 +/-0.127			BP02858-03175-04445-BLG	Bushes - Bronze - Solid - Leaded Gunmetal
28.575 +/-0.0254	31.750 +0.0508/+0.0762	57.150 +/-0.127			BP02858-03175-05715-BLG	Bushes - Bronze - Solid - Leaded Gunmetal
28.575 +/-0.0254	31.750 +0.0508/+0.0762	69.850 +/-0.127			BP02858-03175-06985-BLG	Bushes - Bronze - Solid - Leaded Gunmetal

28.575 x 33.338 mm (1.125 x 1.313 in.)						
28.575 +0.076/+0.102	33.338 +0.064/+0.089	25.400 +/-0.127			BP02858-03334-02540-BS	Bushes - Bronze - Sintered - Unflanged
28.575 +0.076/+0.102	33.338 +0.064/+0.089	31.750 +/-0.127			BP02858-03334-03175-BS	Bushes - Bronze - Sintered - Unflanged
28.575 +0.076/+0.102	33.338 +0.064/+0.089	38.100 +/-0.127			BP02858-03334-03810-BS	Bushes - Bronze - Sintered - Unflanged
28.575 +0.076/+0.102	33.338 +0.064/+0.089	44.450 +/-0.190			BP02858-03334-04445-BS	Bushes - Bronze - Sintered - Unflanged
28.575 +0.076/+0.102	33.338 +0.064/+0.089	50.800 +/-0.190			BP02858-03334-05080-BS	Bushes - Bronze - Sintered - Unflanged

28.575 x 34.925 mm (1.125 x 1.375 in.)						
28.575 +0.076/+0.102	34.925 +0.077/+0.102	19.050 +/-0.127			BP02858-03493-01905-BS	Bushes - Bronze - Sintered - Unflanged
28.575 +0.076/+0.102	34.925 +0.077/+0.102	25.400 +/-0.127			BP02858-03493-02540-BS	Bushes - Bronze - Sintered - Unflanged
28.575 +0.0254/+0.0508	34.925 +0.0508/+0.0762	25.400 +0.127/-0.127			BP02858-03493-02540-BFG	Bushes - Bronze - Sintered - ECO841 Food Grade - Unflanged
28.575 +/-0.0254	34.925 +0.0508/+0.0762	25.400 +/-0.127			BP02858-03493-02540-BC9	Bushes - Bronze - Solid - Leaded Gunmetal
28.575 +0.076/+0.102	34.925 +0.077/+0.102	31.750 +/-0.127			BP02858-03493-03175-BS	Bushes - Bronze - Sintered - Unflanged
28.575 +0.076/+0.102	34.925 +0.077/+0.102	38.100 +/-0.127			BP02858-03493-03810-BS	Bushes - Bronze - Sintered - Unflanged
28.575 +0.076/+0.102	34.925 +0.077/+0.102	44.450 +/-0.190			BP02858-03493-04445-BS	Bushes - Bronze - Sintered - Unflanged
28.575 +/-0.0254	34.925 +0.0508/+0.0762	44.450 +/-0.127			BP02858-03493-04445-BC9	Bushes - Bronze - Solid - Leaded Gunmetal
28.575 +0.076/+0.102	34.925 +0.077/+0.102	50.800 +/-0.190			BP02858-03493-05080-BS	Bushes - Bronze - Sintered - Unflanged
28.575 +/-0.0254	34.925 +0.0508/+0.0762	50.800 +/-0.127			BP02858-03493-05080-BC9	Bushes - Bronze - Solid - Leaded Gunmetal
28.575 +/-0.0254	34.925 +0.0508/+0.0762	50.800 +/-0.127			BP02858-03493-05080-BLG	Bushes - Bronze - Solid - Leaded Gunmetal
28.575 +0.076/+0.102	34.925 +0.077/+0.102	63.500 +/-0.190			BP02858-03493-06350-BS	Bushes - Bronze - Sintered - Unflanged
28.575 +0.076/+0.102	34.925 +0.077/+0.102	76.200 +/-0.190			BP02858-03493-07620-BS	Bushes - Bronze - Sintered - Unflanged
28.575 +/-0.0254	34.925 +0.0508/+0.0762	76.200 +/-0.127			BP02858-03493-07620-BLG	Bushes - Bronze - Solid - Leaded Gunmetal
28.575 +/-0.0254	34.925 +0.0508/+0.0762	88.900 +/-0.127			BP02858-03493-08890-BLG	Bushes - Bronze - Solid - Leaded Gunmetal
28.575 +/-0.0254	34.925 +0.0508/+0.0762	101.600 +/-0.127			BP02858-03493-10160-BC9	Bushes - Bronze - Solid - Leaded Gunmetal
28.575 +/-0.0254	34.925 +0.0508/+0.0762	101.600 +/-0.127			BP02858-03493-10160-BLG	Bushes - Bronze - Solid - Leaded Gunmetal

28.575 x 38.100 mm (1.125 x 1.500 in.)						
28.575 +0.076/+0.102	38.100 +0.077/+0.102	25.400 +/-0.127			BP02858-03810-02540-BS	Bushes - Bronze - Sintered - Unflanged



Stocked or Short Delivery



Usually Available



Long delivery or not in current production

ID	OD	B	DF	bf	Part Number	Type
28.575 x 38.100 mm (1.125 x 1.500 in.)						
28.575 +0.076/+0.102	38.100 +0.077/+0.102	31.750 +/-0.127			BP02858-03810-03175-BS	Bushes - Bronze - Sintered - Unflanged
28.575 +0.076/+0.102	38.100 +0.077/+0.102	38.100 +/-0.127			BP02858-03810-03810-BS	Bushes - Bronze - Sintered - Unflanged
28.575 +0.076/+0.102	38.100 +0.077/+0.102	44.450 +/-0.190			BP02858-03810-04445-BS	Bushes - Bronze - Sintered - Unflanged
28.575 +0.076/+0.102	38.100 +0.077/+0.102	50.800 +/-0.190			BP02858-03810-05080-BS	Bushes - Bronze - Sintered - Unflanged
28.575 +0.076/+0.102	38.100 +0.077/+0.102	63.500 +/-0.190			BP02858-03810-06350-BS	Bushes - Bronze - Sintered - Unflanged
28.575 +/-0.0254	38.100 +0.0508/+0.0762	76.200 +/-0.127			BP02858-03810-07620-BLG	Bushes - Bronze - Solid - Leaded Gunmetal

ID	OD	B	DF	bf	Part Number	Type
30.000 x 34.000 mm (1.181 x 1.339 in.)						
30.000 -0.000/-0.021	34.000 +0.025/-0.000	10.000 +0.25/-0.25			BP03000-03400-01000-DP4	Bushes - Steel - DP4 - Split - Unflanged
30.000 -0.000/-0.041	34.000 +0.085/-0.000	10.000 +0.25/-0.25			BP03000-03400-01000-DU	Bushes - Steel - DU - Split - Unflanged
30.000 -0.000/-0.041	34.000 +0.085/-0.000	12.000 +0.00/-0.30			BP03000-03400-01200-SS6	Bushes - Stainless Steel and PTFE - Unflanged
30.000 -0.000/-0.041	34.000 +0.085/-0.000	12.000 +0.00/-0.30			BP03000-03400-01200-DU	Bushes - Steel - DU - Split - Unflanged
30.000 -0.000/-0.021	34.000 +0.025/-0.000	12.000 +0.25/-0.25			BP03000-03400-01200-DP4	Bushes - Steel - DP4 - Split - Unflanged
30.000 -0.000/-0.041	34.000 +0.085/-0.000	15.000 +0.00/-0.30			BP03000-03400-01500-DU	Bushes - Steel - DU - Split - Unflanged
30.000 -0.000/-0.041	34.000 +0.085/-0.000	15.000 +0.00/-0.30			BP03000-03400-01500-SS6	Bushes - Stainless Steel and PTFE - Unflanged
30.000 -0.000/-0.021	34.000 +0.025/-0.000	15.000 +0.25/-0.25			BP03000-03400-01500-DP4	Bushes - Steel - DP4 - Split - Unflanged
30.000 -0.000/-0.050	34.000 +0.075/-0.000	16.000 +0.25/-0.25	42.00	1.80	BF03000-03400-01600-DUB	Bushes - Steel - DUB - Split - Flanged
30.000 -0.000/-0.025	34.000 +0.025/-0.000	16.000 +0.25/-0.25	42.00	2.00	BF03000-03400-01600-DP4	Bushes - Steel - DP4 - Split - Flanged
30.000 -0.000/-0.050	34.000 +0.075/-0.000	16.000 +0.25/-0.25	42.00	2.00	BF03000-03400-01600-SS6	Bushes - Stainless Steel and PTFE - Flanged
30.000 -0.000/-0.050	34.000 +0.075/-0.000	16.000 +0.25/-0.25	42.00	2.00	BF03000-03400-01600-DU	Bushes - Steel - DU - Split - Flanged
30.000 -0.000/-0.021	34.000 +0.025/-0.000	20.000 +0.25/-0.25			BP03000-03400-02000-DP4	Bushes - Steel - DP4 - Split - Unflanged
30.000 -0.000/-0.041	34.000 +0.085/-0.000	20.000 +0.00/-0.30			BP03000-03400-02000-DU	Bushes - Steel - DU - Split - Unflanged
30.000 -0.000/-0.041	34.000 +0.085/-0.000	20.000 +0.00/-0.30			BP03000-03400-02000-SS6	Bushes - Stainless Steel and PTFE - Unflanged
30.000 -0.000/-0.041	34.000 +0.085/-0.000	20.000 +0.25/-0.25			BP03000-03400-02000-DUB	Bushes - Steel - DUB - Split - Unflanged
30.000 -0.000/-0.041	34.000 +0.085/-0.000	20.000 +0.25/-0.25			BP03000-03400-02000-DX	Bushes - Steel - DX - Split - Unflanged
30.000 -0.000/-0.021	34.000 +0.025/-0.000	25.000 +0.25/-0.25			BP03000-03400-02500-DP4	Bushes - Steel - DP4 - Split - Unflanged
30.000 -0.000/-0.041	34.000 +0.085/-0.000	25.000 +0.00/-0.30			BP03000-03400-02500-DU	Bushes - Steel - DU - Split - Unflanged
30.000 -0.000/-0.041	34.000 +0.085/-0.000	25.000 +0.00/-0.30			BP03000-03400-02500-SS6	Bushes - Stainless Steel and PTFE - Unflanged
30.000 -0.000/-0.050	34.000 +0.075/-0.000	26.000 +0.25/-0.25	42.00	1.80	BF03000-03400-02600-DUB	Bushes - Steel - DUB - Split - Flanged
30.000 -0.000/-0.050	34.000 +0.075/-0.000	26.000 +0.25/-0.25	42.00	2.00	BF03000-03400-02600-DU	Bushes - Steel - DU - Split - Flanged
30.000 -0.000/-0.050	34.000 +0.075/-0.000	26.000 +0.25/-0.25	42.00	2.00	BF03000-03400-02600-SS6	Bushes - Stainless Steel and PTFE - Flanged
30.000 -0.000/-0.025	34.000 +0.025/-0.000	26.000 +0.25/-0.25	42.00	2.00	BF03000-03400-02600-DP4	Bushes - Steel - DP4 - Split - Flanged
30.000 -0.000/-0.041	34.000 +0.085/-0.000	30.000 +0.00/-0.30			BP03000-03400-03000-SS6	Bushes - Stainless Steel and PTFE - Unflanged
30.000 -0.000/-0.021	34.000 +0.025/-0.000	30.000 +0.25/-0.25			BP03000-03400-03000-DP4	Bushes - Steel - DP4 - Split - Unflanged
30.000 -0.000/-0.041	34.000 +0.085/-0.000	30.000 +0.00/-0.30			BP03000-03400-03000-DU	Bushes - Steel - DU - Split - Unflanged
30.000 -0.000/-0.041	34.000 +0.085/-0.000	30.000 +0.25/-0.25			BP03000-03400-03000-DUB	Bushes - Steel - DUB - Split - Unflanged
30.000 -0.000/-0.041	34.000 +0.085/-0.000	30.000 +0.25/-0.25			BP03000-03400-03000-DX	Bushes - Steel - DX - Split - Unflanged
30.000 -0.000/-0.021	34.000 +0.025/-0.000	40.000 +0.25/-0.25			BP03000-03400-04000-DP4	Bushes - Steel - DP4 - Split - Unflanged
30.000 -0.000/-0.041	34.000 +0.085/-0.000	40.000 +0.00/-0.30			BP03000-03400-04000-DU	Bushes - Steel - DU - Split - Unflanged
30.000 -0.000/-0.041	34.000 +0.085/-0.000	40.000 +0.00/-0.30			BP03000-03400-04000-SS6	Bushes - Stainless Steel and PTFE - Unflanged
30.000 -0.000/-0.041	34.000 +0.085/-0.000	40.000 +0.25/-0.25			BP03000-03400-04000-DUB	Bushes - Steel - DUB - Split - Unflanged
30.000 -0.000/-0.041	34.000 +0.085/-0.000	40.000 +0.25/-0.25			BP03000-03400-04000-DX	Bushes - Steel - DX - Split - Unflanged

 Stocked or Short Delivery

 Usually Available

 Long delivery or not in current production

ID	OD	B	DF	bf	Part Number	Type
30.000 x 35.000 mm (1.181 x 1.378 in.)						
30.000 +0.007/+0.028	35.000 +0.043/+0.068	20.000 +/-0.160			BP03000-03500-02000-BSO	Bushes - Bronze - Sintered - Unflanged - Oilite
30.000 +0.007/+0.028	35.000 +0.043/+0.068	25.000 +/-0.160			BP03000-03500-02500-BSO	Bushes - Bronze - Sintered - Unflanged - Oilite
30.000 +0.007/+0.028	35.000 +0.043/+0.068	30.000 +/-0.160			BP03000-03500-03000-BSO	Bushes - Bronze - Sintered - Unflanged - Oilite
30.000 +/-0.0254	35.000 +0.0508/+0.0762	30.000 +/-0.127			BP03000-03500-03000-BLG	Bushes - Bronze - Solid - Leaded Gunmetal
30.000 +/-0.0254	35.000 +0.0508/+0.0762	40.000 +/-0.127			BP03000-03500-04000-BLG	Bushes - Bronze - Solid - Leaded Gunmetal
30.000 +/-0.0254	35.000 +0.0508/+0.0762	50.000 +/-0.127			BP03000-03500-05000-BLG	Bushes - Bronze - Solid - Leaded Gunmetal
30.000 +/-0.0254	35.000 +0.0508/+0.0762	60.000 +/-0.127			BP03000-03500-06000-BLG	Bushes - Bronze - Solid - Leaded Gunmetal
30.000 +/-0.0254	35.000 +0.0508/+0.0762	80.000 +/-0.127			BP03000-03500-08000-BLG	Bushes - Bronze - Solid - Leaded Gunmetal
30.000 +/-0.0254	35.000 +0.0508/+0.0762	100.000 +/-0.127			BP03000-03500-10000-BLG	Bushes - Bronze - Solid - Leaded Gunmetal
30.000 x 38.000 mm (1.181 x 1.496 in.)						
30.000 +0.007/+0.028	38.000 +0.043/+0.068	20.000 +/-0.160	46.00	4.00	BF03000-03800-02000-BSO	Bushes - Bronze - Sintered - Flanged - Oilite
30.000 +0.007/+0.028	38.000 +0.043/+0.068	25.000 +/-0.160	46.00	4.00	BF03000-03800-02500-BSO	Bushes - Bronze - Sintered - Flanged - Oilite
30.000 +0.007/+0.028	38.000 +0.043/+0.068	30.000 +/-0.160	46.00	4.00	BF03000-03800-03000-BSO	Bushes - Bronze - Sintered - Flanged - Oilite
30.000 x 40.000 mm (1.181 x 1.575 in.)						
30.000 +0.007/+0.028	40.000 +0.043/+0.068	25.000 +/-0.160			BP03000-04000-02500-BSO	Bushes - Bronze - Sintered - Unflanged - Oilite
30.000 +/-0.0254	40.000 +0.0508/+0.0762	30.000 +/-0.127			BP03000-04000-03000-BLG	Bushes - Bronze - Solid - Leaded Gunmetal
30.000 +0.007/+0.028	40.000 +0.043/+0.068	35.000 +/-0.190			BP03000-04000-03500-BSO	Bushes - Bronze - Sintered - Unflanged - Oilite
30.000 +/-0.0254	40.000 +0.0508/+0.0762	40.000 +/-0.127			BP03000-04000-04000-BLG	Bushes - Bronze - Solid - Leaded Gunmetal
30.000 +0.007/+0.028	40.000 +0.043/+0.068	50.000 +/-0.190			BP03000-04000-05000-BSO	Bushes - Bronze - Sintered - Unflanged - Oilite
30.000 +/-0.0254	40.000 +0.0508/+0.0762	50.000 +/-0.127			BP03000-04000-05000-BLG	Bushes - Bronze - Solid - Leaded Gunmetal
30.000 +/-0.0254	40.000 +0.0508/+0.0762	60.000 +/-0.127			BP03000-04000-06000-BLG	Bushes - Bronze - Solid - Leaded Gunmetal
30.000 +/-0.0254	40.000 +0.0508/+0.0762	80.000 +/-0.127			BP03000-04000-08000-BLG	Bushes - Bronze - Solid - Leaded Gunmetal
30.000 +/-0.0254	40.000 +0.0508/+0.0762	100.000 +/-0.127			BP03000-04000-10000-BLG	Bushes - Bronze - Solid - Leaded Gunmetal
30.163 x 36.513 mm (1.188 x 1.438 in.)						
30.163 +0.076/+0.102	36.513 +0.064/+0.089	31.750 +/-0.127			BP03016-03651-03175-BS	Bushes - Bronze - Sintered - Unflanged
30.163 +0.076/+0.102	36.513 +0.064/+0.089	38.100 +/-0.127			BP03016-03651-03810-BS	Bushes - Bronze - Sintered - Unflanged
30.163 +0.076/+0.102	36.513 +0.064/+0.089	50.800 +/-0.190			BP03016-03651-05080-BS	Bushes - Bronze - Sintered - Unflanged
30.163 +0.076/+0.102	36.513 +0.064/+0.089	63.500 +/-0.190			BP03016-03651-06350-BS	Bushes - Bronze - Sintered - Unflanged
30.163 +0.076/+0.102	36.513 +0.064/+0.089	76.200 +/-0.190			BP03016-03651-07620-BS	Bushes - Bronze - Sintered - Unflanged
30.163 x 38.100 mm (1.188 x 1.500 in.)						
30.163 +0.076/+0.102	38.100 +0.077/+0.102	25.400 +/-0.127			BP03016-03810-02540-BS	Bushes - Bronze - Sintered - Unflanged
30.163 +0.076/+0.102	38.100 +0.077/+0.102	31.750 +/-0.127			BP03016-03810-03175-BS	Bushes - Bronze - Sintered - Unflanged
30.163 +0.076/+0.102	38.100 +0.077/+0.102	38.100 +/-0.127			BP03016-03810-03810-BS	Bushes - Bronze - Sintered - Unflanged
30.163 +0.076/+0.102	38.100 +0.077/+0.102	44.450 +/-0.127			BP03016-03810-04445-BS	Bushes - Bronze - Sintered - Unflanged
30.163 +0.076/+0.102	38.100 +0.077/+0.102	50.800 +/-0.127			BP03016-03810-05080-BS	Bushes - Bronze - Sintered - Unflanged
30.163 +0.076/+0.102	38.100 +0.077/+0.102	63.500 +/-0.190			BP03016-03810-06350-BS	Bushes - Bronze - Sintered - Unflanged
30.163 +0.076/+0.102	38.100 +0.077/+0.102	76.200 +/-0.190			BP03016-03810-07620-BS	Bushes - Bronze - Sintered - Unflanged
31.750 x 34.925 mm (1.250 x 1.375 in.)						
31.750 +/-0.0254	34.925 +0.0508/+0.0762	38.100 +/-0.127			BP03175-03493-03810-BLG	Bushes - Bronze - Solid - Leaded Gunmetal

Stocked or Short Delivery

Usually Available

Long delivery or not in current production

ID	OD	B	DF	bf	Part Number	Type
31.750 x 34.925 mm (1.250 x 1.375 in.)						
31.750 +/-0.0254	34.925 +0.0508/+0.0762	76.200 +/-0.127			BP03175-03493-07620-BLG	Bushes - Bronze - Solid - Leaded Gunmetal
31.750 x 35.712 mm (1.250 x 1.406 in.)						
31.750 -0.030/-0.071	35.712 +0.014/-0.027	9.525 +0.25/-0.25			BP03175-03571-00953-SS6	Bushes - Stainless Steel and PTFE - Unflanged
31.750 -0.030/-0.071	35.712 +0.014/-0.027	9.525 +0.00/-0.40			BP03175-03571-00953-DP4	Bushes - Steel - DP4 - Split - Unflanged
31.750 -0.030/-0.071	35.712 +0.014/-0.027	9.525 +0.00/-0.40			BP03175-03571-00953-DU	Bushes - Steel - DU - Split - Unflanged
31.750 -0.030/-0.071	35.712 +0.014/-0.027	19.050 +0.00/-0.40			BP03175-03571-01905-DU	Bushes - Steel - DU - Split - Unflanged
31.750 -0.030/-0.071	35.712 +0.014/-0.027	19.050 +0.00/-0.40			BP03175-03571-01905-DP4	Bushes - Steel - DP4 - Split - Unflanged
31.750 -0.030/-0.071	35.712 +0.014/-0.027	19.050 +0.25/-0.25			BP03175-03571-01905-SS6	Bushes - Stainless Steel and PTFE - Unflanged
31.750 -0.030/-0.071	35.712 +0.014/-0.027	22.225 +0.00/-0.40			BP03175-03571-02223-DU	Bushes - Steel - DU - Split - Unflanged
31.750 -0.030/-0.071	35.712 +0.014/-0.027	22.225 +0.25/-0.25			BP03175-03571-02223-SS6	Bushes - Stainless Steel and PTFE - Unflanged
31.750 -0.030/-0.071	35.712 +0.014/-0.027	22.225 +0.00/-0.40			BP03175-03571-02223-DP4	Bushes - Steel - DP4 - Split - Unflanged
31.750 -0.030/-0.071	35.712 +0.014/-0.027	25.400 +0.00/-0.40			BP03175-03571-02540-DU	Bushes - Steel - DU - Split - Unflanged
31.750 -0.030/-0.071	35.712 +0.014/-0.027	25.400 +0.25/-0.25			BP03175-03571-02540-SS6	Bushes - Stainless Steel and PTFE - Unflanged
31.750 -0.030/-0.071	35.712 +0.014/-0.027	25.400 +0.00/-0.40			BP03175-03571-02540-DP4	Bushes - Steel - DP4 - Split - Unflanged
31.750 -0.030/-0.071	35.712 +0.014/-0.011	25.400 +0.25/-0.25	44.96	2.11	BF03175-03571-02540-DP4	Bushes - Steel - DP4 - Split - Flanged
31.750 -0.030/-0.071	35.712 +0.014/-0.011	25.400 +0.25/-0.25	44.96	2.11	BF03175-03571-02540-DU	Bushes - Steel - DU - Split - Flanged
31.750 -0.030/-0.071	35.712 +0.014/-0.011	25.400 +0.25/-0.25	44.96	2.11	BF03175-03571-02540-SS6	Bushes - Stainless Steel and PTFE - Flanged
31.750 -0.030/-0.071	35.712 +0.014/-0.027	31.750 +0.00/-0.40			BP03175-03571-03175-DU	Bushes - Steel - DU - Split - Unflanged
31.750 -0.030/-0.071	35.712 +0.014/-0.027	31.750 +0.00/-0.40			BP03175-03571-03175-DP4	Bushes - Steel - DP4 - Split - Unflanged
31.750 -0.030/-0.071	35.712 +0.014/-0.027	31.750 +0.25/-0.25			BP03175-03571-03175-SS6	Bushes - Stainless Steel and PTFE - Unflanged
31.750 -0.030/-0.071	35.712 +0.014/-0.011	31.750 +0.25/-0.25	44.96	2.11	BF03175-03571-03175-DP4	Bushes - Steel - DP4 - Split - Flanged
31.750 -0.030/-0.071	35.712 +0.014/-0.011	31.750 +0.25/-0.25	44.96	2.11	BF03175-03571-03175-DU	Bushes - Steel - DU - Split - Flanged
31.750 -0.030/-0.071	35.712 +0.014/-0.011	31.750 +0.25/-0.25	44.96	2.11	BF03175-03571-03175-SS6	Bushes - Stainless Steel and PTFE - Flanged
31.750 -0.030/-0.071	35.712 +0.014/-0.011	38.100 +0.25/-0.25	44.96	2.11	BF03175-03571-03810-DP4	Bushes - Steel - DP4 - Split - Flanged
31.750 -0.030/-0.071	35.712 +0.014/-0.011	38.100 +0.25/-0.25	44.96	2.11	BF03175-03571-03810-DU	Bushes - Steel - DU - Split - Flanged
31.750 -0.030/-0.071	35.712 +0.014/-0.011	38.100 +0.25/-0.25	44.96	2.11	BF03175-03571-03810-SS6	Bushes - Stainless Steel and PTFE - Flanged
31.750 -0.030/-0.071	35.712 +0.014/-0.027	44.450 +0.00/-0.40			BP03175-03571-04445-DP4	Bushes - Steel - DP4 - Split - Unflanged
31.750 -0.030/-0.071	35.712 +0.014/-0.027	44.450 +0.00/-0.40			BP03175-03571-04445-DU	Bushes - Steel - DU - Split - Unflanged
31.750 -0.030/-0.071	35.712 +0.014/-0.027	44.450 +0.25/-0.25			BP03175-03571-04445-SS6	Bushes - Stainless Steel and PTFE - Unflanged
31.750 x 38.100 mm (1.250 x 1.500 in.)						
31.750 +0.076/+0.102	38.100 +0.077/+0.102	12.700 +/-0.127			BP03175-03810-01270-BS	Bushes - Bronze - Sintered - Unflanged
31.750 +0.076/+0.102	38.100 +0.077/+0.102	15.875 +/-0.127			BP03175-03810-01588-BS	Bushes - Bronze - Sintered - Unflanged
31.750 +0.076/+0.102	38.100 +0.077/+0.102	19.050 +/-0.127			BP03175-03810-01905-BS	Bushes - Bronze - Sintered - Unflanged
31.750 +0.0254/+0.0508	38.100 +0.0635/+0.0762	19.050 +0.127/-0.127			BP03175-03810-01905-BFG	Bushes - Bronze - Sintered - ECO841 Food Grade - Unflanged
31.750 +0.076/+0.102	38.100 +0.077/+0.102	22.225 +/-0.127			BP03175-03810-02223-BS	Bushes - Bronze - Sintered - Unflanged
31.750 +0.076/+0.102	38.100 +0.077/+0.102	25.400 +/-0.127			BP03175-03810-02540-BS	Bushes - Bronze - Sintered - Unflanged
31.750 +0.0254/+0.0508	38.100 +0.0635/+0.0762	25.400 +0.127/-0.127			BP03175-03810-02540-BFG	Bushes - Bronze - Sintered - ECO841 Food Grade - Unflanged
31.750 +/-0.0254	38.100 +0.0508/+0.0762	25.400 +/-0.127			BP03175-03810-02540-BLG	Bushes - Bronze - Solid - Leaded Gunmetal
31.750 +0.025/+0.050	38.100 +0.051/+0.076	25.400 +/-0.127	44.45	4.76	BF03175-03810-02540-BS	Bushes - Bronze - Sintered - Flanged
31.750 +0.076/+0.102	38.100 +0.077/+0.102	28.575 +/-0.127			BP03175-03810-02858-BS	Bushes - Bronze - Sintered - Unflanged

Stocked or Short Delivery

Usually Available

Long delivery or not in current production

ID	OD	B	DF	bf	Part Number	Type
----	----	---	----	----	-------------	------

31.750 x 38.100 mm (1.250 x 1.500 in.)						
31.750 +0.076/+0.102	38.100 +0.077/+0.102	31.750 +/-0.127			BP03175-03810-03175-BS	Bushes - Bronze - Sintered - Unflanged
31.750 +0.025/+0.050	38.100 +0.051/+0.076	31.750 +/-0.127	44.45	4.76	BF03175-03810-03175-BS	Bushes - Bronze - Sintered - Flanged
31.750 +0.076/+0.102	38.100 +0.077/+0.102	34.925 +/-0.127			BP03175-03810-03493-BS	Bushes - Bronze - Sintered - Unflanged
31.750 +0.076/+0.102	38.100 +0.077/+0.102	38.100 +/-0.127			BP03175-03810-03810-BS	Bushes - Bronze - Sintered - Unflanged
31.750 +0.0254/+0.0508	38.100 +0.0635/+0.0762	38.100 +0.190/-0.190			BP03175-03810-03810-BFG	Bushes - Bronze - Sintered - ECO841 Food Grade - Unflanged
31.750 +/-0.0254	38.100 +0.0508/+0.0762	38.100 +/-0.127			BP03175-03810-03810-BC9	Bushes - Bronze - Solid - Leaded Gunmetal
31.750 +/-0.0254	38.100 +0.0508/+0.0762	38.100 +/-0.127			BP03175-03810-03810-BLG	Bushes - Bronze - Solid - Leaded Gunmetal
31.750 +0.076/+0.102	38.100 +0.077/+0.102	41.275 +/-0.190			BP03175-03810-04128-BS	Bushes - Bronze - Sintered - Unflanged
31.750 +0.076/+0.102	38.100 +0.077/+0.102	44.450 +/-0.190			BP03175-03810-04445-BS	Bushes - Bronze - Sintered - Unflanged
31.750 +/-0.0254	38.100 +0.0508/+0.0762	44.450 +/-0.127			BP03175-03810-04445-BLG	Bushes - Bronze - Solid - Leaded Gunmetal
31.750 +0.076/+0.102	38.100 +0.077/+0.102	47.625 +/-0.190			BP03175-03810-04763-BS	Bushes - Bronze - Sintered - Unflanged
31.750 +0.076/+0.102	38.100 +0.077/+0.102	50.800 +/-0.190			BP03175-03810-05080-BS	Bushes - Bronze - Sintered - Unflanged
31.750 +/-0.0254	38.100 +0.0508/+0.0762	50.800 +/-0.127			BP03175-03810-05080-BC9	Bushes - Bronze - Solid - Leaded Gunmetal
31.750 +/-0.0254	38.100 +0.0508/+0.0762	50.800 +/-0.127			BP03175-03810-05080-BLG	Bushes - Bronze - Solid - Leaded Gunmetal
31.750 +0.076/+0.102	38.100 +0.077/+0.102	57.150 +/-0.190			BP03175-03810-05715-BS	Bushes - Bronze - Sintered - Unflanged
31.750 +0.076/+0.102	38.100 +0.077/+0.102	63.500 +/-0.190			BP03175-03810-06350-BS	Bushes - Bronze - Sintered - Unflanged
31.750 +/-0.0254	38.100 +0.0508/+0.0762	63.500 +/-0.127			BP03175-03810-06350-BLG	Bushes - Bronze - Solid - Leaded Gunmetal
31.750 +0.076/+0.102	38.100 +0.077/+0.102	76.200 +/-0.190			BP03175-03810-07620-BS	Bushes - Bronze - Sintered - Unflanged
31.750 +/-0.0254	38.100 +0.0508/+0.0762	76.200 +/-0.127			BP03175-03810-07620-BC9	Bushes - Bronze - Solid - Leaded Gunmetal
31.750 +/-0.0254	38.100 +0.0508/+0.0762	76.200 +/-0.127			BP03175-03810-07620-BLG	Bushes - Bronze - Solid - Leaded Gunmetal
31.750 +/-0.0254	38.100 +0.0508/+0.0762	88.900 +/-0.127			BP03175-03810-08890-BLG	Bushes - Bronze - Solid - Leaded Gunmetal
31.750 +/-0.0254	38.100 +0.0508/+0.0762	101.600 +/-0.127			BP03175-03810-10160-BC9	Bushes - Bronze - Solid - Leaded Gunmetal
31.750 +/-0.0254	38.100 +0.0508/+0.0762	101.600 +/-0.127			BP03175-03810-10160-BLG	Bushes - Bronze - Solid - Leaded Gunmetal

31.750 x 39.688 mm (1.250 x 1.563 in.)						
31.750 +0.076/+0.102	39.688 +0.051/+0.089	25.400 +/-0.127			BP03175-03969-02540-BS	Bushes - Bronze - Sintered - Unflanged
31.750 +0.076/+0.102	39.688 +0.051/+0.089	38.100 +/-0.127			BP03175-03969-03810-BS	Bushes - Bronze - Sintered - Unflanged
31.750 +0.076/+0.102	39.688 +0.051/+0.089	50.800 +/-0.190			BP03175-03969-05080-BS	Bushes - Bronze - Sintered - Unflanged

31.750 x 41.275 mm (1.250 x 1.625 in.)						
31.750 +0.013/-0.000	41.275 +0.013/-0.000	22.225 +0.00/-1.52	45.72	4.76	BF03175-04128-02223-BAG	Bushes - Aluminium Bronze - Graphite Plug - Flanged
31.750 +0.013/-0.000	41.275 +0.013/-0.000	22.225 +0.00/-1.52	45.72	4.76	BF03175-04128-02223-BA	Bushes - Aluminium Bronze - Flanged
31.750 +0.076/+0.102	41.275 +0.064/+0.102	25.400 +/-0.127			BP03175-04128-02540-BS	Bushes - Bronze - Sintered - Unflanged
31.750 +0.013/-0.000	41.275 +0.013/-0.000	31.750 +0.00/-1.52			BP03175-04128-03175-BA	Bushes - Aluminium Bronze - Unflanged
31.75 +0.013/-0.000	41.275 +0.013/-0.000	31.750 +0.00/-1.52			BP03175-04128-03175-BAG	Bushes - Aluminium Bronze - Graphite Plug - Unflanged
31.750 +0.076/+0.102	41.275 +0.064/+0.102	31.750 +/-0.127			BP03175-04128-03175-BS	Bushes - Bronze - Sintered - Unflanged
31.750 +0.013/-0.000	41.275 +0.013/-0.000	34.925 +0.00/-1.52			BP03175-04128-03493-BA	Bushes - Aluminium Bronze - Unflanged
31.750 +0.013/-0.000	41.275 +0.013/-0.000	34.925 +0.00/-1.52			BP03175-04128-03493-BAG	Bushes - Aluminium Bronze - Graphite Plug - Unflanged
31.750 +0.013/-0.000	41.275 +0.013/-0.000	34.925 +0.00/-1.52	45.72	4.76	BF03175-04128-03493-BA	Bushes - Aluminium Bronze - Flanged
31.750 +0.013/-0.000	41.275 +0.013/-0.000	34.925 +0.00/-1.52	45.72	4.76	BF03175-04128-03493-BAG	Bushes - Aluminium Bronze - Graphite Plug - Flanged
31.750 +0.013/-0.000	41.275 +0.013/-0.000	38.100 +0.00/-1.52			BP03175-04128-03810-BA	Bushes - Aluminium Bronze - Unflanged
31.750 +0.013/-0.000	41.275 +0.013/-0.000	38.100 +0.00/-1.52			BP03175-04128-03810-BAG	Bushes - Aluminium Bronze - Graphite Plug - Unflanged

 Stocked or Short Delivery

 Usually Available

 Long delivery or not in current production

ID	OD	B	DF	bf	Part Number	Type
31.750 x 41.275 mm (1.250 x 1.625 in.)						
31.750 +0.076/+0.102	41.275 +0.064/+0.102	38.100 +/-0.127			BP03175-04128-03810-BS	Bushes - Bronze - Sintered - Unflanged
31.750 +0.013/-0.000	41.275 +0.013/-0.000	44.450 +0.00/-1.52			BP03175-04128-04445-BA	Bushes - Aluminium Bronze - Unflanged
31.750 +0.076/+0.102	41.275 +0.064/+0.102	44.450 +/-0.190			BP03175-04128-04445-BS	Bushes - Bronze - Sintered - Unflanged
31.750 +0.013/-0.000	41.275 +0.013/-0.000	44.450 +0.00/-1.52			BP03175-04128-04445-BAG	Bushes - Aluminium Bronze - Graphite Plug - Unflanged
31.750 +/-0.0254	41.275 +0.0508/+0.0762	44.450 +/-0.127			BP03175-04128-04445-BLG	Bushes - Bronze - Solid - Leaded Gunmetal
31.750 +0.013/-0.000	41.275 +0.013/-0.000	47.625 +0.00/-1.52			BP03175-04128-04763-BA	Bushes - Aluminium Bronze - Unflanged
31.750 +0.013/-0.000	41.275 +0.013/-0.000	47.625 +0.00/-1.52			BP03175-04128-04763-BAG	Bushes - Aluminium Bronze - Graphite Plug - Unflanged
31.750 +0.013/-0.000	41.275 +0.013/-0.000	47.625 +0.00/-1.52	45.72	4.76	BF03175-04128-04763-BA	Bushes - Aluminium Bronze - Flanged
31.750 +0.013/-0.000	41.275 +0.013/-0.000	47.625 +0.00/-1.52	45.72	4.76	BF03175-04128-04763-BAG	Bushes - Aluminium Bronze - Graphite Plug - Flanged
31.750 +0.076/+0.102	41.275 +0.064/+0.102	50.800 +/-0.190			BP03175-04128-05080-BS	Bushes - Bronze - Sintered - Unflanged
31.750 +0.013/-0.000	41.275 +0.013/-0.000	50.800 +0.00/-1.52			BP03175-04128-05080-BA	Bushes - Aluminium Bronze - Unflanged
31.750 +0.013/-0.000	41.275 +0.013/-0.000	50.800 +0.00/-1.52			BP03175-04128-05080-BAG	Bushes - Aluminium Bronze - Graphite Plug - Unflanged
31.750 +0.013/-0.000	41.275 +0.013/-0.000	60.325 +0.00/-1.52	45.72	4.76	BF03175-04128-06033-BA	Bushes - Aluminium Bronze - Flanged
31.750 +0.013/-0.000	41.275 +0.013/-0.000	60.325 +0.00/-1.52	45.72	4.76	BF03175-04128-06033-BAG	Bushes - Aluminium Bronze - Graphite Plug - Flanged
31.750 +0.076/+0.102	41.275 +0.064/+0.102	63.500 +/-0.190			BP03175-04128-06350-BS	Bushes - Bronze - Sintered - Unflanged
31.750 +0.013/-0.000	41.275 +0.013/-0.000	73.025 +0.00/-1.52	45.72	4.76	BF03175-04128-07303-BAG	Bushes - Aluminium Bronze - Graphite Plug - Flanged
31.750 +0.013/-0.000	41.275 +0.013/-0.000	73.025 +0.00/-1.52	45.72	4.76	BF03175-04128-07303-BA	Bushes - Aluminium Bronze - Flanged
31.750 +0.013/-0.000	41.275 +0.013/-0.000	76.200 +0.00/-1.52			BP03175-04128-07620-BAG	Bushes - Aluminium Bronze - Graphite Plug - Unflanged
31.750 +0.076/+0.102	41.275 +0.064/+0.102	76.200 +/-0.190			BP03175-04128-07620-BS	Bushes - Bronze - Sintered - Unflanged
31.750 +0.013/-0.000	41.275 +0.013/-0.000	76.200 +0.00/-1.52			BP03175-04128-07620-BA	Bushes - Aluminium Bronze - Unflanged
31.750 +0.013/-0.000	41.275 +0.013/-0.000	85.725 +0.00/-1.52	45.72	4.76	BF03175-04128-08573-BA	Bushes - Aluminium Bronze - Flanged
31.750 +0.013/-0.000	41.275 +0.013/-0.000	85.725 +0.00/-1.52	45.72	4.76	BF03175-04128-08573-BAG	Bushes - Aluminium Bronze - Graphite Plug - Flanged
31.750 +0.013/-0.000	41.275 +0.013/-0.000	98.425 +0.00/-1.52	45.72	4.76	BF03175-04128-09843-BA	Bushes - Aluminium Bronze - Flanged
31.750 +0.013/-0.000	41.275 +0.013/-0.000	98.425 +0.00/-1.52	45.72	4.76	BF03175-04128-09843-BAG	Bushes - Aluminium Bronze - Graphite Plug - Flanged
31.750 +0.013/-0.000	41.275 +0.013/-0.000	111.125 +0.00/-1.52	45.72	4.76	BF03175-04128-11113-BAG	Bushes - Aluminium Bronze - Graphite Plug - Flanged
31.750 +0.013/-0.000	41.275 +0.013/-0.000	111.125 +0.00/-1.52	45.72	4.76	BF03175-04128-11113-BA	Bushes - Aluminium Bronze - Flanged
31.750 +0.013/-0.000	41.275 +0.013/-0.000	123.825 +0.00/-1.52	45.72	4.76	BF03175-04128-12383-BA	Bushes - Aluminium Bronze - Flanged
31.750 +0.013/-0.000	41.275 +0.013/-0.000	123.825 +0.00/-1.52	45.72	4.76	BF03175-04128-12383-BAG	Bushes - Aluminium Bronze - Graphite Plug - Flanged
31.750 +0.013/-0.000	41.275 +0.013/-0.000	149.225 +0.00/-1.52	45.72	4.76	BF03175-04128-14923-BA	Bushes - Aluminium Bronze - Flanged
31.750 +0.013/-0.000	41.275 +0.013/-0.000	149.225 +0.00/-1.52	45.72	4.76	BF03175-04128-14923-BAG	Bushes - Aluminium Bronze - Graphite Plug - Flanged
31.750 x 44.450 mm (1.250 x 1.750 in.)						
31.750 +0.076/+0.102	44.450 +0.064/+0.102	38.100 +/-0.127			BP03175-04445-03810-BS	Bushes - Bronze - Sintered - Unflanged
31.750 +0.076/+0.102	44.450 +0.064/+0.102	44.450 +/-0.190			BP03175-04445-04445-BS	Bushes - Bronze - Sintered - Unflanged
31.750 +0.076/+0.102	44.450 +0.064/+0.102	50.800 +/-0.190			BP03175-04445-05080-BS	Bushes - Bronze - Sintered - Unflanged
31.750 +0.076/+0.102	44.450 +0.064/+0.102	63.500 +/-0.190			BP03175-04445-06350-BS	Bushes - Bronze - Sintered - Unflanged
31.750 +0.076/+0.102	44.450 +0.064/+0.102	76.200 +/-0.190			BP03175-04445-07620-BS	Bushes - Bronze - Sintered - Unflanged
32.000 x 36.000 mm (1.260 x 1.417 in.)						
32.000 -0.000/-0.050	36.000 +0.085/-0.000	20.000 +0.00/-0.40			BP03200-03600-02000-DU	Bushes - Steel - DU - Split - Unflanged
32.000 -0.000/-0.050	36.000 +0.085/-0.000	20.000 +0.00/-0.40			BP03200-03600-02000-SS6	Bushes - Stainless Steel and PTFE - Unflanged
32.000 -0.000/-0.025	36.000 +0.025/-0.000	20.000 +0.25/-0.25			BP03200-03600-02000-DP4	Bushes - Steel - DP4 - Split - Unflanged

 Stocked or Short Delivery

 Usually Available

 Long delivery or not in current production

ID	OD	B	DF	bf	Part Number	Type
32.000 x 36.000 mm (1.260 x 1.417 in.)						
32.000 -0.000/-0.050	36.000 +0.085/-0.000	20.000 +0.25/-0.25			BP03200-03600-02000-DX	Bushes - Steel - DX - Split - Unflanged
32.000 -0.000/-0.050	36.000 +0.085/-0.000	30.000 +0.00/-0.40			BP03200-03600-03000-SS6	Bushes - Stainless Steel and PTFE - Unflanged
32.000 -0.000/-0.025	36.000 +0.025/-0.000	30.000 +0.25/-0.25			BP03200-03600-03000-DP4	Bushes - Steel - DP4 - Split - Unflanged
32.000 -0.000/-0.050	36.000 +0.085/-0.000	30.000 +0.00/-0.40			BP03200-03600-03000-DU	Bushes - Steel - DU - Split - Unflanged
32.000 -0.000/-0.050	36.000 +0.085/-0.000	30.000 +0.25/-0.25			BP03200-03600-03000-DX	Bushes - Steel - DX - Split - Unflanged
32.000 -0.000/-0.050	36.000 +0.085/-0.000	35.000 +0.25/-0.25			BP03200-03600-03500-DX	Bushes - Steel - DX - Split - Unflanged
32.000 -0.000/-0.025	36.000 +0.025/-0.000	40.000 +0.25/-0.25			BP03200-03600-04000-DP4	Bushes - Steel - DP4 - Split - Unflanged
32.000 -0.000/-0.050	36.000 +0.085/-0.000	40.000 +0.00/-0.40			BP03200-03600-04000-DU	Bushes - Steel - DU - Split - Unflanged
32.000 -0.000/-0.050	36.000 +0.085/-0.000	40.000 +0.00/-0.40			BP03200-03600-04000-SS6	Bushes - Stainless Steel and PTFE - Unflanged
32.000 -0.000/-0.050	36.000 +0.085/-0.000	40.000 +0.25/-0.25			BP03200-03600-04000-DX	Bushes - Steel - DX - Split - Unflanged
32.000 x 38.000 mm (1.260 x 1.496 in.)						
32.000 +0.009/+0.034	38.000 +0.043/+0.068	25.000 +/-0.160	46.00	4.00	BF03200-03800-02500-BSO	Bushes - Bronze - Sintered - Flanged - Oilite
32.000 +0.009/+0.034	38.000 +0.043/+0.068	32.000 +/-0.190	46.00	4.00	BF03200-03800-03200-BSO	Bushes - Bronze - Sintered - Flanged - Oilite
33.338 x 39.688 mm (1.313 x 1.563 in.)						
33.338 +0.076/+0.102	39.688 +0.051/+0.089	25.400 +/-0.127			BP03334-03969-02540-BS	Bushes - Bronze - Sintered - Unflanged
33.338 +0.076/+0.102	39.688 +0.051/+0.089	38.100 +/-0.127			BP03334-03969-03810-BS	Bushes - Bronze - Sintered - Unflanged
33.338 +0.076/+0.102	39.688 +0.051/+0.089	50.800 +/-0.190			BP03334-03969-05080-BS	Bushes - Bronze - Sintered - Unflanged
33.338 x 41.275 mm (1.313 x 1.625 in.)						
33.338 +0.076/+0.102	41.275 +0.064/+0.102	31.750 +/-0.127			BP03334-04128-03175-BS	Bushes - Bronze - Sintered - Unflanged
33.338 +0.076/+0.102	41.275 +0.064/+0.102	38.100 +/-0.127			BP03334-04128-03810-BS	Bushes - Bronze - Sintered - Unflanged
33.338 +0.076/+0.102	41.275 +0.064/+0.102	50.800 +/-0.190			BP03334-04128-05080-BS	Bushes - Bronze - Sintered - Unflanged
33.338 +0.076/+0.102	41.275 +0.064/+0.102	63.500 +/-0.190			BP03334-04128-06350-BS	Bushes - Bronze - Sintered - Unflanged
33.338 +/-0.0254	41.275 +0.0508/+0.0762	63.500 +/-0.127			BP03334-04128-06350-BC9	Bushes - Bronze - Solid - Leaded Gunmetal
33.338 +0.076/+0.102	41.275 +0.064/+0.102	76.200 +/-0.190			BP03334-04128-07620-BS	Bushes - Bronze - Sintered - Unflanged
34.925 x 38.894 mm (1.375 x 1.531 in.)						
34.925 -0.030/-0.071	38.894 +0.014/-0.027	19.050 +0.25/-0.25			BP03493-03889-01905-SS6	Bushes - Stainless Steel and PTFE - Unflanged
34.925 -0.030/-0.071	38.894 +0.014/-0.027	19.050 +0.00/-0.40			BP03493-03889-01905-DU	Bushes - Steel - DU - Split - Unflanged
34.925 -0.030/-0.071	38.894 +0.014/-0.027	19.050 +0.00/-0.40			BP03493-03889-01905-DP4	Bushes - Steel - DP4 - Split - Unflanged
34.925 -0.030/-0.071	38.894 +0.014/-0.027	34.925 +0.00/-0.40			BP03493-03889-03493-DP4	Bushes - Steel - DP4 - Split - Unflanged
34.925 -0.030/-0.071	38.894 +0.014/-0.027	34.925 +0.00/-0.40			BP03493-03889-03493-DU	Bushes - Steel - DU - Split - Unflanged
34.925 -0.030/-0.071	38.894 +0.014/-0.027	34.925 +0.25/-0.25			BP03493-03889-03493-SS6	Bushes - Stainless Steel and PTFE - Unflanged
34.925 -0.030/-0.071	38.894 +0.014/-0.027	38.100 +0.00/-0.40			BP03493-03889-03810-DP4	Bushes - Steel - DP4 - Split - Unflanged
34.925 -0.030/-0.071	38.894 +0.014/-0.027	38.100 +0.00/-0.40			BP03493-03889-03810-DU	Bushes - Steel - DU - Split - Unflanged
34.925 -0.030/-0.071	38.894 +0.014/-0.027	38.100 +0.25/-0.25			BP03493-03889-03810-SS6	Bushes - Stainless Steel and PTFE - Unflanged
34.925 -0.030/-0.071	38.894 +0.014/-0.027	44.450 +0.00/-0.40			BP03493-03889-04445-DP4	Bushes - Steel - DP4 - Split - Unflanged
34.925 -0.030/-0.071	38.894 +0.014/-0.027	44.450 +0.00/-0.40			BP03493-03889-04445-DU	Bushes - Steel - DU - Split - Unflanged
34.925 -0.030/-0.071	38.894 +0.014/-0.027	44.450 +0.25/-0.25			BP03493-03889-04445-SS6	Bushes - Stainless Steel and PTFE - Unflanged
34.925 x 41.275 mm (1.375 x 1.625 in.)						
34.925 +0.076/+0.102	41.275 +0.064/+0.102	25.400 +/-0.127			BP03493-04128-02540-BS	Bushes - Bronze - Sintered - Unflanged

Stocked or Short Delivery

Usually Available

Long delivery or not in current production

ID	OD	B	DF	bf	Part Number	Type
----	----	---	----	----	-------------	------

34.925 x 41.275 mm (1.375 x 1.625 in.)						
34.925 +0.076/+0.102	41.275 +0.064/+0.102	28.575 +/-0.127			BP03493-04128-02858-BS	Bushes - Bronze - Sintered - Unflanged
34.925 +0.076/+0.102	41.275 +0.064/+0.102	31.750 +/-0.127			BP03493-04128-03175-BS	Bushes - Bronze - Sintered - Unflanged
34.925 +0.076/+0.102	41.275 +0.064/+0.102	38.100 +/-0.127			BP03493-04128-03810-BS	Bushes - Bronze - Sintered - Unflanged
34.925 +0.076/+0.102	41.275 +0.064/+0.102	50.800 +/-0.190			BP03493-04128-05080-BS	Bushes - Bronze - Sintered - Unflanged
34.925 +/-0.0254	41.275 +0.0508/+0.0762	50.800 +/-0.127			BP03493-04128-05080-BLG	Bushes - Bronze - Solid - Leaded Gunmetal
34.925 +0.076/+0.102	41.275 +0.064/+0.102	63.500 +/-0.190			BP03493-04128-06350-BS	Bushes - Bronze - Sintered - Unflanged
34.925 +0.076/+0.102	41.275 +0.064/+0.102	76.200 +/-0.190			BP03493-04128-07620-BS	Bushes - Bronze - Sintered - Unflanged
34.925 +/-0.0254	41.275 +0.0508/+0.0762	76.200 +/-0.127			BP03493-04128-07620-BC9	Bushes - Bronze - Solid - Leaded Gunmetal
34.925 +/-0.0254	41.275 +0.0508/+0.0762	76.200 +/-0.127			BP03493-04128-07620-BLG	Bushes - Bronze - Solid - Leaded Gunmetal
34.925 +/-0.0254	41.275 +0.0508/+0.0762	101.600 +/-0.127			BP03493-04128-10160-BLG	Bushes - Bronze - Solid - Leaded Gunmetal

34.925 x 44.450 mm (1.375 x 1.750 in.)						
34.925 +0.076/+0.102	44.450 +0.064/+0.102	25.400 +/-0.127			BP03493-04445-02540-BS	Bushes - Bronze - Sintered - Unflanged
34.925 +0.076/+0.102	44.450 +0.064/+0.102	38.100 +/-0.127			BP03493-04445-03810-BS	Bushes - Bronze - Sintered - Unflanged
34.925 +0.076/+0.102	44.450 +0.064/+0.102	50.800 +/-0.190			BP03493-04445-05080-BS	Bushes - Bronze - Sintered - Unflanged
34.925 +0.076/+0.102	44.450 +0.064/+0.102	63.500 +/-0.190			BP03493-04445-06350-BS	Bushes - Bronze - Sintered - Unflanged
34.925 +0.076/+0.102	44.450 +0.064/+0.102	76.200 +/-0.190			BP03493-04445-07620-BS	Bushes - Bronze - Sintered - Unflanged
34.925 +/-0.0254	44.450 +0.0508/+0.0762	101.600 +/-0.127			BP03493-04445-10160-BLG	Bushes - Bronze - Solid - Leaded Gunmetal

35.000 x 39.000 mm (1.378 x 1.535 in.)						
35.000 -0.000/-0.050	39.000 +0.085/-0.000	12.000 +0.00/-0.40			BP03500-03900-01200-DU	Bushes - Steel - DU - Split - Unflanged
35.000 -0.000/-0.050	39.000 +0.085/-0.000	12.000 +0.00/-0.40			BP03500-03900-01200-SS6	Bushes - Stainless Steel and PTFE - Unflanged
35.000 -0.000/-0.025	39.000 +0.085/-0.000	12.000 +0.00/-0.40			BP03500-03900-01200-DP4	Bushes - Steel - DP4 - Split - Unflanged
35.000 -0.000/-0.025	39.000 +0.085/-0.000	15.000 +0.00/-0.40			BP03500-03900-01500-DU	Bushes - Steel - DU - Split - Unflanged
35.000 -0.000/-0.050	39.000 +0.085/-0.000	15.000 +0.00/-0.40			BP03500-03900-01500-SS6	Bushes - Stainless Steel and PTFE - Unflanged
35.000 -0.000/-0.025	39.000 +0.085/-0.000	15.000 +0.00/-0.40			BP03500-03900-01500-DP4	Bushes - Steel - DP4 - Split - Unflanged
35.000 -0.000/-0.050	39.000 +0.085/-0.000	16.000 +0.25/-0.25	47.00	2.00	BF03500-03900-01600-SS6	Bushes - Stainless Steel and PTFE - Flanged
35.000 -0.000/-0.025	39.000 +0.025/-0.000	16.000 +0.25/-0.25	47.00	2.00	BF03500-03900-01600-DP4	Bushes - Steel - DP4 - Split - Flanged
35.000 -0.000/-0.050	39.000 +0.085/-0.000	16.000 +0.25/-0.25	47.00	2.00	BF03500-03900-01600-DU	Bushes - Steel - DU - Split - Flanged
35.000 -0.000/-0.025	39.000 +0.025/-0.000	20.000 +0.25/-0.25			BP03500-03900-02000-DP4	Bushes - Steel - DP4 - Split - Unflanged
35.000 -0.000/-0.025	39.000 +0.085/-0.000	20.000 +0.00/-0.40			BP03500-03900-02000-DU	Bushes - Steel - DU - Split - Unflanged
35.000 -0.000/-0.050	39.000 +0.085/-0.000	20.000 +0.00/-0.40			BP03500-03900-02000-SS6	Bushes - Stainless Steel and PTFE - Unflanged
35.000 -0.000/-0.025	39.000 +0.085/-0.000	20.000 +0.25/-0.25			BP03500-03900-02000-DUB	Bushes - Steel - DUB - Split - Unflanged
35.000 -0.000/-0.050	39.000 +0.085/-0.000	20.000 +0.25/-0.25			BP03500-03900-02000-DX	Bushes - Steel - DX - Split - Unflanged
35.000 -0.000/-0.025	39.000 +0.085/-0.000	25.000 +0.00/-0.40			BP03500-03900-02500-DP4	Bushes - Steel - DP4 - Split - Unflanged
35.000 -0.000/-0.025	39.000 +0.085/-0.000	25.000 +0.00/-0.40			BP03500-03900-02500-DU	Bushes - Steel - DU - Split - Unflanged
35.000 -0.000/-0.050	39.000 +0.085/-0.000	25.000 +0.00/-0.40			BP03500-03900-02500-SS6	Bushes - Stainless Steel and PTFE - Unflanged
35.000 -0.000/-0.050	39.000 +0.085/-0.000	26.000 +0.25/-0.25	47.00	1.80	BF03500-03900-02600-DUB	Bushes - Steel - DUB - Split - Flanged
35.000 -0.000/-0.050	39.000 +0.085/-0.000	26.000 +0.25/-0.25	47.00	2.00	BF03500-03900-02600-SS6	Bushes - Stainless Steel and PTFE - Flanged
35.000 -0.000/-0.025	39.000 +0.025/-0.000	26.000 +0.25/-0.25	47.00	2.00	BF03500-03900-02600-DP4	Bushes - Steel - DP4 - Split - Flanged
35.000 -0.000/-0.050	39.000 +0.085/-0.000	26.000 +0.25/-0.25	47.00	2.00	BF03500-03900-02600-DU	Bushes - Steel - DU - Split - Flanged
35.000 -0.000/-0.050	39.000 +0.085/-0.000	30.000 +0.00/-0.40			BP03500-03900-03000-SS6	Bushes - Stainless Steel and PTFE - Unflanged

Stocked or Short Delivery

Usually Available

Long delivery or not in current production

ID	OD	B	DF	bf	Part Number	Type
35.000 x 39.000 mm (1.378 x 1.535 in.)						
35.000 -0.000/-0.025	39.000 +0.025/-0.000	30.000 +0.25/-0.25			BP03500-03900-03000-DP4	Bushes - Steel - DP4 - Split - Unflanged
35.000 -0.000/-0.025	39.000 +0.085/-0.000	30.000 +0.00/-0.40			BP03500-03900-03000-DU	Bushes - Steel - DU - Split - Unflanged
35.000 -0.000/-0.025	39.000 +0.085/-0.000	30.000 +0.25/-0.25			BP03500-03900-03000-DUB	Bushes - Steel - DUB - Split - Unflanged
35.000 -0.000/-0.050	39.000 +0.085/-0.000	30.000 +0.25/-0.25			BP03500-03900-03000-DX	Bushes - Steel - DX - Split - Unflanged
35.000 -0.000/-0.025	39.000 +0.025/-0.000	35.000 +0.25/-0.25			BP03500-03900-03500-DP4	Bushes - Steel - DP4 - Split - Unflanged
35.000 -0.000/-0.025	39.000 +0.085/-0.000	35.000 +0.25/-0.25			BP03500-03900-03500-DU	Bushes - Steel - DU - Split - Unflanged
35.000 -0.000/-0.025	39.000 +0.085/-0.000	35.000 +0.25/-0.25			BP03500-03900-03500-DX	Bushes - Steel - DX - Split - Unflanged
35.000 -0.000/-0.025	39.000 +0.025/-0.000	40.000 +0.25/-0.25			BP03500-03900-04000-DP4	Bushes - Steel - DP4 - Split - Unflanged
35.000 -0.000/-0.025	39.000 +0.085/-0.000	40.000 +0.00/-0.40			BP03500-03900-04000-DU	Bushes - Steel - DU - Split - Unflanged
35.000 -0.000/-0.050	39.000 +0.085/-0.000	40.000 +0.00/-0.40			BP03500-03900-04000-SS6	Bushes - Stainless Steel and PTFE - Unflanged
35.000 -0.000/-0.025	39.000 +0.025/-0.000	50.000 +0.25/-0.25			BP03500-03900-05000-DP4	Bushes - Steel - DP4 - Split - Unflanged
35.000 -0.000/-0.025	39.000 +0.085/-0.000	50.000 +0.00/-0.40			BP03500-03900-05000-DU	Bushes - Steel - DU - Split - Unflanged
35.000 -0.000/-0.050	39.000 +0.085/-0.000	50.000 +0.00/-0.40			BP03500-03900-05000-SS6	Bushes - Stainless Steel and PTFE - Unflanged
35.000 -0.000/-0.050	39.000 +0.085/-0.000	50.000 +0.25/-0.25			BP03500-03900-05000-DX	Bushes - Steel - DX - Split - Unflanged
35.000 x 40.000 mm (1.378 x 1.575 in.)						
35.000 +/-0.0254	40.000 +0.0508/+0.0762	40.000 +/-0.127			BP03500-04000-04000-BLG	Bushes - Bronze - Solid - Leaded Gunmetal
35.000 +/-0.0254	40.000 +0.0508/+0.0762	50.000 +/-0.127			BP03500-04000-05000-BLG	Bushes - Bronze - Solid - Leaded Gunmetal
35.000 +/-0.0254	40.000 +0.0508/+0.0762	60.000 +/-0.127			BP03500-04000-06000-BLG	Bushes - Bronze - Solid - Leaded Gunmetal
35.000 +/-0.0254	40.000 +0.0508/+0.0762	80.000 +/-0.127			BP03500-04000-08000-BLG	Bushes - Bronze - Solid - Leaded Gunmetal
35.000 +/-0.0254	40.000 +0.0508/+0.0762	100.000 +/-0.127			BP03500-04000-10000-BLG	Bushes - Bronze - Solid - Leaded Gunmetal
35.000 x 45.000 mm (1.378 x 1.772 in.)						
35.000 +0.009/+0.025	45.000 +0.043/+0.068	25.000 +/-0.160	55.00	5.00	BF03500-04500-02500-BSO	Bushes - Bronze - Sintered - Flanged - Oilite
35.000 +0.009/+0.025	45.000 +0.043/+0.068	35.000 +/-0.190	55.00	5.00	BF03500-04500-03500-BSO	Bushes - Bronze - Sintered - Flanged - Oilite
35.000 +/-0.0254	45.000 +0.0508/+0.0762	40.000 +/-0.127			BP03500-04500-04000-BLG	Bushes - Bronze - Solid - Leaded Gunmetal
35.000 +0.009/+0.025	45.000 +0.043/+0.068	40.000 +/-0.190	55.00	5.00	BF03500-04500-04000-BSO	Bushes - Bronze - Sintered - Flanged - Oilite
35.000 +/-0.0254	45.000 +0.0508/+0.0762	50.000 +/-0.127			BP03500-04500-05000-BLG	Bushes - Bronze - Solid - Leaded Gunmetal
35.000 +/-0.0254	45.000 +0.0508/+0.0762	60.000 +/-0.127			BP03500-04500-06000-BLG	Bushes - Bronze - Solid - Leaded Gunmetal
35.000 +/-0.0254	45.000 +0.0508/+0.0762	80.000 +/-0.127			BP03500-04500-08000-BLG	Bushes - Bronze - Solid - Leaded Gunmetal
35.000 +/-0.0254	45.000 +0.0508/+0.0762	100.000 +/-0.127			BP03500-04500-10000-BLG	Bushes - Bronze - Solid - Leaded Gunmetal
36.000 x 40.000 mm (1.417 x 1.575 in.)						
36.000 -0.000/-0.050	40.000 +0.085/-0.000	35.000 +0.25/-0.25			BP03600-04000-03500-DX	Bushes - Steel - DX - Split - Unflanged
36.513 x 41.275 mm (1.438 x 1.625 in.)						
36.513 +0.076/+0.102	41.275 +0.064/+0.102	25.400 +/-0.127			BP03651-04128-02540-BS	Bushes - Bronze - Sintered - Unflanged
36.513 +0.076/+0.102	41.275 +0.064/+0.102	38.100 +/-0.127			BP03651-04128-03810-BS	Bushes - Bronze - Sintered - Unflanged
36.513 +0.076/+0.102	41.275 +0.064/+0.102	50.800 +/-0.190			BP03651-04128-05080-BS	Bushes - Bronze - Sintered - Unflanged
36.513 x 44.450 mm (1.438 x 1.750 in.)						
36.513 +0.076/+0.102	44.450 +0.064/+0.102	19.050 +/-0.127			BP03651-04445-01905-BS	Bushes - Bronze - Sintered - Unflanged
36.513 +0.076/+0.102	44.450 +0.064/+0.102	25.400 +/-0.127			BP03651-04445-02540-BS	Bushes - Bronze - Sintered - Unflanged
36.513 +0.076/+0.102	44.450 +0.064/+0.102	31.750 +/-0.127			BP03651-04445-03175-BS	Bushes - Bronze - Sintered - Unflanged

 Stocked or Short Delivery

 Usually Available

 Long delivery or not in current production

ID	OD	B	DF	bf	Part Number	Type
36.513 x 44.450 mm (1.438 x 1.750 in.)						
36.513 +0.102/+0.127	44.450 +0.051/+0.089	38.100 +/-0.127			BP03651-04445-03810-BS13	Bushes - Bronze - Sintered - Unflanged
36.513 +0.076/+0.102	44.450 +0.064/+0.102	38.100 +/-0.127			BP03651-04445-03810-BS10	Bushes - Bronze - Sintered - Unflanged
36.513 +0.076/+0.102	44.450 +0.064/+0.102	44.450 +/-0.190			BP03651-04445-04445-BS	Bushes - Bronze - Sintered - Unflanged
36.513 +0.076/+0.102	44.450 +0.064/+0.102	50.800 +/-0.190			BP03651-04445-05080-BS	Bushes - Bronze - Sintered - Unflanged
36.513 +0.076/+0.102	44.450 +0.064/+0.102	63.500 +/-0.190			BP03651-04445-06350-BS	Bushes - Bronze - Sintered - Unflanged
36.513 +0.076/+0.102	44.450 +0.064/+0.102	76.200 +/-0.190			BP03651-04445-07620-BS	Bushes - Bronze - Sintered - Unflanged
37.000 x 41.000 mm (1.457 x 1.614 in.)						
37.000 -0.000/-0.025	41.000 +0.025/-0.000	20.000 +0.25/-0.25			BP03700-04100-02000-DP4	Bushes - Steel - DP4 - Split - Unflanged
37.000 -0.000/-0.025	41.000 +0.025/-0.000	20.000 +0.25/-0.25			BP03700-04100-02000-DU	Bushes - Steel - DU - Split - Unflanged
37.000 -0.000/-0.025	41.000 +0.025/-0.000	20.000 +0.25/-0.25			BP03700-04100-02000-DX	Bushes - Steel - DX - Split - Unflanged
38.000 x 42.000 mm (1.496 x 1.654 in.)						
38.000 -0.000/-0.050	42.000 +0.085/-0.000	15.000 +0.00/-0.40			BP03800-04200-01500-SS6	Bushes - Stainless Steel and PTFE - Unflanged
38.000 -0.000/-0.050	42.000 +0.085/-0.000	15.000 +0.00/-0.40			BP03800-04200-01500-DP4	Bushes - Steel - DP4 - Split - Unflanged
38.000 -0.000/-0.050	42.000 +0.085/-0.000	15.000 +0.00/-0.40			BP03800-04200-01500-DU	Bushes - Steel - DU - Split - Unflanged
38.000 -0.000/-0.050	42.000 +0.085/-0.000	30.000 +0.00/-0.40			BP03800-04200-03000-DP4	Bushes - Steel - DP4 - Split - Unflanged
38.000 -0.000/-0.050	42.000 +0.085/-0.000	30.000 +0.00/-0.40			BP03800-04200-03000-DU	Bushes - Steel - DU - Split - Unflanged
38.000 -0.000/-0.050	42.000 +0.085/-0.000	30.000 +0.00/-0.40			BP03800-04200-03000-SS6	Bushes - Stainless Steel and PTFE - Unflanged
38.000 -0.000/-0.050	42.000 +0.085/-0.000	40.000 +0.00/-0.40			BP03800-04200-04000-SS6	Bushes - Stainless Steel and PTFE - Unflanged
38.000 -0.000/-0.050	42.000 +0.085/-0.000	40.000 +0.00/-0.40			BP03800-04200-04000-DU	Bushes - Steel - DU - Split - Unflanged
38.000 -0.000/-0.050	42.000 +0.085/-0.000	40.000 +0.00/-0.40			BP03800-04200-04000-DP4	Bushes - Steel - DP4 - Split - Unflanged
38.100 x 41.275 mm (1.500 x 1.625 in.)						
38.100 +/-0.0254	41.275 +0.0508/+0.0762	50.800 +/-0.127			BP03810-04128-05080-BLG	Bushes - Bronze - Solid - Leaded Gunmetal
38.100 x 41.910 mm (1.500 x 1.650 in.)						
38.100 -0.000/-0.030	41.910 +0.014/-0.011	25.400 +0.25/-0.25	51.31	2.11	BF03810-04191-02540-SS6	Bushes - Stainless Steel and PTFE - Flanged
38.100 -0.000/-0.041	41.910 +0.014/-0.011	25.400 +0.25/-0.25	51.31	2.11	BF03810-04191-02540-DU	Bushes - Steel - DU - Split - Flanged
38.100 -0.000/-0.041	41.910 +0.014/-0.011	25.400 +0.25/-0.25	51.31	2.11	BF03810-04191-02540-DP4	Bushes - Steel - DP4 - Split - Flanged
38.100 -0.000/-0.041	41.910 +0.014/-0.011	38.100 +0.25/-0.25	51.31	2.11	BF03810-04191-03810-DU	Bushes - Steel - DU - Split - Flanged
38.100 -0.000/-0.030	41.910 +0.014/-0.011	38.100 +0.25/-0.25	51.31	2.11	BF03810-04191-03810-SS6	Bushes - Stainless Steel and PTFE - Flanged
38.100 -0.000/-0.041	41.910 +0.014/-0.011	38.100 +0.25/-0.25	51.31	2.11	BF03810-04191-03810-DP4	Bushes - Steel - DP4 - Split - Flanged
38.100 -0.000/-0.041	41.910 +0.014/-0.011	50.800 +0.25/-0.25	51.31	2.11	BF03810-04191-05080-DP4	Bushes - Steel - DP4 - Split - Flanged
38.100 -0.000/-0.041	41.910 +0.014/-0.011	50.800 +0.25/-0.25	51.31	2.11	BF03810-04191-05080-DU	Bushes - Steel - DU - Split - Flanged
38.100 -0.000/-0.030	41.910 +0.014/-0.011	50.800 +0.25/-0.25	51.31	2.11	BF03810-04191-05080-SS6	Bushes - Stainless Steel and PTFE - Flanged
38.100 x 42.069 mm (1.500 x 1.656 in.)						
38.100 -0.000/-0.071	42.069 +0.014/-0.027	12.700 +0.00/-0.40			BP03810-04207-01270-DP4	Bushes - Steel - DP4 - Split - Unflanged
38.100 -0.000/-0.071	42.069 +0.014/-0.027	12.700 +0.00/-0.40			BP03810-04207-01270-DU	Bushes - Steel - DU - Split - Unflanged
38.100 -0.000/-0.071	42.069 +0.014/-0.027	12.700 +0.25/-0.25			BP03810-04207-01270-SS6	Bushes - Stainless Steel and PTFE - Unflanged
38.100 -0.000/-0.071	42.069 +0.014/-0.027	25.400 +0.25/-0.25			BP03810-04207-02540-SS6	Bushes - Stainless Steel and PTFE - Unflanged
38.100 -0.000/-0.071	42.069 +0.014/-0.027	25.400 +0.00/-0.40			BP03810-04207-02540-DP4	Bushes - Steel - DP4 - Split - Unflanged
38.100 -0.000/-0.071	42.069 +0.014/-0.027	25.400 +0.00/-0.40			BP03810-04207-02540-DU	Bushes - Steel - DU - Split - Unflanged

Stocked or Short Delivery

Usually Available

Long delivery or not in current production

ID	OD	B	DF	bf	Part Number	Type
38.100 x 42.069 mm (1.500 x 1.656 in.)						
38.100 -0.000/-0.071	42.069 +0.014/-0.027	28.575 +0.25/-0.25			BP03810-04207-02858-SS6	Bushes - Stainless Steel and PTFE - Unflanged
38.100 -0.000/-0.071	42.069 +0.014/-0.027	28.575 +0.00/-0.40			BP03810-04207-02858-DP4	Bushes - Steel - DP4 - Split - Unflanged
38.100 -0.000/-0.071	42.069 +0.014/-0.027	28.575 +0.00/-0.40			BP03810-04207-02858-DU	Bushes - Steel - DU - Split - Unflanged
38.100 -0.000/-0.071	42.069 +0.014/-0.027	31.750 +0.00/-0.40			BP03810-04207-03175-DP4	Bushes - Steel - DP4 - Split - Unflanged
38.100 -0.000/-0.071	42.069 +0.014/-0.027	31.750 +0.00/-0.40			BP03810-04207-03175-DU	Bushes - Steel - DU - Split - Unflanged
38.100 -0.000/-0.071	42.069 +0.014/-0.027	31.750 +0.25/-0.25			BP03810-04207-03175-SS6	Bushes - Stainless Steel and PTFE - Unflanged
38.100 -0.000/-0.071	42.069 +0.014/-0.027	38.100 +0.00/-0.40			BP03810-04207-03810-DU	Bushes - Steel - DU - Split - Unflanged
38.100 -0.000/-0.071	42.069 +0.014/-0.027	38.100 +0.25/-0.25			BP03810-04207-03810-SS6	Bushes - Stainless Steel and PTFE - Unflanged
38.100 -0.000/-0.071	42.069 +0.014/-0.027	38.100 +0.00/-0.40			BP03810-04207-03810-DP4	Bushes - Steel - DP4 - Split - Unflanged
38.100 -0.000/-0.071	42.069 +0.014/-0.027	50.800 +0.00/-0.40			BP03810-04207-05080-DU	Bushes - Steel - DU - Split - Unflanged
38.100 -0.000/-0.071	42.069 +0.014/-0.027	50.800 +0.25/-0.25			BP03810-04207-05080-SS6	Bushes - Stainless Steel and PTFE - Unflanged
38.100 -0.000/-0.071	42.069 +0.014/-0.027	50.800 +0.00/-0.40			BP03810-04207-05080-DP4	Bushes - Steel - DP4 - Split - Unflanged
38.100 x 44.445 mm (1.500 x 1.750 in.)						
38.100 +/-0.0254	44.445 +0.0508/+0.0762	25.400 +/-0.127			BP03810-04445-02540-BC9	Bushes - Bronze - Solid - Leaded Gunmetal
38.100 +/-0.0254	44.445 +0.0508/+0.0762	44.445 +/-0.127			BP03810-04445-04445-BC9	Bushes - Bronze - Solid - Leaded Gunmetal
38.100 +/-0.0254	44.445 +0.0508/+0.0762	76.200 +/-0.127			BP03810-04445-07620-BC9	Bushes - Bronze - Solid - Leaded Gunmetal
38.100 x 44.450 mm (1.500 x 1.750 in.)						
38.100 +0.076/+0.102	44.450 +0.064/+0.102	12.700 +/-0.127			BP03810-04445-01270-BS	Bushes - Bronze - Sintered - Unflanged
38.100 +0.076/+0.102	44.450 +0.064/+0.102	19.050 +/-0.127			BP03810-04445-01905-BS	Bushes - Bronze - Sintered - Unflanged
38.100 +0.0762/+0.1016	44.450 +0.0635/+0.0762	25.400 +0.127/-0.127			BP03810-04445-02540-BS	Bushes - Bronze - Sintered - Unflanged
38.100 +0.0762/+0.1016	44.450 +0.0635/+0.0762	25.400 +0.127/-0.127			BP03810-04445-02540-BFG	Bushes - Bronze - Sintered - ECO841 Food Grade - Unflanged
38.100 +0.076/+0.102	44.450 +0.064/+0.102	31.750 +/-0.127			BP03810-04445-03175-BS	Bushes - Bronze - Sintered - Unflanged
38.100 +0.076/+0.102	44.450 +0.064/+0.102	34.925 +/-0.127			BP03810-04445-03493-BS	Bushes - Bronze - Sintered - Unflanged
38.100 +0.0762/+0.1016	44.450 +0.0635/+0.0762	38.100 +0.190/-0.190			BP03810-04445-03810-BS	Bushes - Bronze - Sintered - Unflanged
38.100 +0.0762/+0.1016	44.450 +0.0635/+0.0762	38.100 +0.190/-0.190			BP03810-04445-03810-BFG	Bushes - Bronze - Sintered - ECO841 Food Grade - Unflanged
38.100 +/-0.0254	44.450 +0.0508/+0.0762	38.100 +/-0.127			BP03810-04445-03810-BLG	Bushes - Bronze - Solid - Leaded Gunmetal
38.100 +0.050/+0.076	44.450 +0.064/+0.102	38.100 +/-0.127	52.39	4.76	BF03810-04445-03810-BS	Bushes - Bronze - Sintered - Flanged
38.100 +0.076/+0.102	44.450 +0.064/+0.102	44.450 +/-0.190			BP03810-04445-04445-BS	Bushes - Bronze - Sintered - Unflanged
38.100 +0.076/+0.102	44.450 +0.064/+0.102	50.800 +/-0.190			BP03810-04445-05080-BS10	Bushes - Bronze - Sintered - Unflanged
38.100 +0.0762/+0.1016	44.450 +0.0635/+0.0762	50.800 +0.190/-0.190			BP03810-04445-05080-BS	Bushes - Bronze - Sintered - Unflanged
38.100 +0.050/+0.076	44.450 +0.064/+0.102	50.800 +/-0.190			BP03810-04445-05080-BS08	Bushes - Bronze - Sintered - Unflanged
38.100 +0.0762/+0.1016	44.450 +0.0635/+0.0762	50.800 +0.190/-0.190			BP03810-04445-05080-BFG	Bushes - Bronze - Sintered - ECO841 Food Grade - Unflanged
38.100 +/-0.0254	44.450 +0.0508/+0.0762	50.800 +/-0.127			BP03810-04445-05080-BLG	Bushes - Bronze - Solid - Leaded Gunmetal
38.100 +0.076/+0.102	44.450 +0.064/+0.102	57.150 +/-0.190			BP03810-04445-05715-BS	Bushes - Bronze - Sintered - Unflanged
38.100 +0.076/+0.102	44.450 +0.064/+0.102	63.500 +/-0.190			BP03810-04445-06350-BS	Bushes - Bronze - Sintered - Unflanged
38.100 +/-0.0254	44.450 +0.0508/+0.0762	63.500 +/-0.127			BP03810-04445-06350-BLG	Bushes - Bronze - Solid - Leaded Gunmetal
38.100 +0.076/+0.102	44.450 +0.064/+0.102	76.200 +/-0.190			BP03810-04445-07620-BS	Bushes - Bronze - Sintered - Unflanged
38.100 +/-0.0254	44.450 +0.0508/+0.0762	76.200 +/-0.127			BP03810-04445-07620-BLG	Bushes - Bronze - Solid - Leaded Gunmetal
38.100 +/-0.0254	44.450 +0.0508/+0.0762	88.900 +/-0.127			BP03810-04445-08890-BLG	Bushes - Bronze - Solid - Leaded Gunmetal

 Stocked or Short Delivery

 Usually Available

 Long delivery or not in current production

ID	OD	B	DF	bf	Part Number	Type
38.100 x 44.450 mm (1.500 x 1.750 in.)						
38.100 +/-0.0254	44.450 +0.0508/+0.0762	101.600 +/-0.127			BP03810-04445-10160-BLG	Bushes - Bronze - Solid - Leaded Gunmetal
38.100 x 46.038 mm (1.500 x 1.813 in.)						
38.100 +0.076/+0.102	46.038 +0.051/+0.089	25.400 +/-0.127			BP03810-04604-02540-BS	Bushes - Bronze - Sintered - Unflanged
38.100 +0.076/+0.102	46.038 +0.051/+0.089	38.100 +/-0.127			BP03810-04604-03810-BS	Bushes - Bronze - Sintered - Unflanged
38.100 +0.076/+0.102	46.038 +0.051/+0.089	41.275 +/-0.190			BP03810-04604-04128-BS	Bushes - Bronze - Sintered - Unflanged
38.100 +0.076/+0.102	46.038 +0.051/+0.089	50.800 +/-0.190			BP03810-04604-05080-BS	Bushes - Bronze - Sintered - Unflanged
38.100 +0.076/+0.102	46.038 +0.051/+0.089	76.200 +/-0.190			BP03810-04604-07620-BS	Bushes - Bronze - Sintered - Unflanged
38.100 x 47.625 mm (1.500 x 1.875 in.)						
38.100 +0.076/+0.102	47.625 +0.064/+0.102	38.100 +/-0.190			BP03810-04763-03810-BS	Bushes - Bronze - Sintered - Unflanged
38.100 +0.076/+0.102	47.625 +0.064/+0.102	50.800 +/-0.190			BP03810-04763-05080-BS	Bushes - Bronze - Sintered - Unflanged
38.100 +/-0.0254	47.625 +0.0508/+0.0762	50.800 +/-0.127			BP03810-04763-05080-BC9	Bushes - Bronze - Solid - Leaded Gunmetal
38.100 +0.076/+0.102	47.625 +0.064/+0.102	63.500 +/-0.190			BP03810-04763-06350-BS	Bushes - Bronze - Sintered - Unflanged
38.100 +0.076/+0.102	47.625 +0.064/+0.102	69.850 +/-0.190			BP03810-04763-06985-BS	Bushes - Bronze - Sintered - Unflanged
38.100 +0.076/+0.102	47.625 +0.064/+0.102	76.200 +/-0.190			BP03810-04763-07620-BS	Bushes - Bronze - Sintered - Unflanged
38.100 x 50.800 mm (1.500 x 2.000 in.)						
38.100 +0.013/-0.000	50.800 +0.013/-0.000	22.225 +0.00/-1.52	55.37	4.76	BF03810-05080-02223-BA	Bushes - Aluminium Bronze - Flanged
38.100 +0.013/-0.000	50.800 +0.013/-0.000	22.225 +0.00/-1.52	55.37	4.76	BF03810-05080-02223-BAG	Bushes - Aluminium Bronze - Graphite Plug - Flanged
38.100 +0.076/+0.102	50.800 +0.064/+0.102	25.400 +/-0.127			BP03810-05080-02540-BS	Bushes - Bronze - Sintered - Unflanged
38.100 +0.013/-0.000	50.800 +0.013/-0.000	31.750 +0.00/-1.52			BP03810-05080-03175-BA	Bushes - Aluminium Bronze - Unflanged
38.100 +0.013/-0.000	50.800 +0.013/-0.000	31.750 +0.00/-1.52			BP03810-05080-03175-BAG	Bushes - Aluminium Bronze - Graphite Plug - Unflanged
38.100 +0.013/-0.000	50.800 +0.013/-0.000	34.925 +0.00/-1.52			BP03810-05080-03493-BA	Bushes - Aluminium Bronze - Unflanged
38.100 +0.013/-0.000	50.800 +0.013/-0.000	34.925 +0.00/-1.52			BP03810-05080-03493-BAG	Bushes - Aluminium Bronze - Graphite Plug - Unflanged
38.100 +0.013/-0.000	50.800 +0.013/-0.000	34.925 +0.00/-1.52	55.37	4.76	BF03810-05080-03493-BA	Bushes - Aluminium Bronze - Flanged
38.100 +0.013/-0.000	50.800 +0.013/-0.000	34.925 +0.00/-1.52	55.37	4.76	BF03810-05080-03493-BAG	Bushes - Aluminium Bronze - Graphite Plug - Flanged
38.100 +0.013/-0.000	50.800 +0.013/-0.000	38.100 +0.00/-1.52			BP03810-05080-03810-BA	Bushes - Aluminium Bronze - Unflanged
38.100 +0.076/+0.102	50.800 +0.064/+0.102	38.100 +/-0.127			BP03810-05080-03810-BS	Bushes - Bronze - Sintered - Unflanged
38.100 +0.013/-0.000	50.800 +0.013/-0.000	38.100 +0.00/-1.52			BP03810-05080-03810-BAG	Bushes - Aluminium Bronze - Graphite Plug - Unflanged
38.100 +0.013/-0.000	50.800 +0.013/-0.000	44.450 +0.00/-1.52			BP03810-05080-04445-BA	Bushes - Aluminium Bronze - Unflanged
38.100 +0.013/-0.000	50.800 +0.013/-0.000	44.450 +0.00/-1.52			BP03810-05080-04445-BAG	Bushes - Aluminium Bronze - Graphite Plug - Unflanged
38.100 +0.013/-0.000	50.800 +0.013/-0.000	47.625 +0.00/-1.52			BP03810-05080-04763-BA	Bushes - Aluminium Bronze - Unflanged
38.100 +0.013/-0.000	50.800 +0.013/-0.000	47.625 +0.00/-1.52			BP03810-05080-04763-BAG	Bushes - Aluminium Bronze - Graphite Plug - Unflanged
38.100 +0.013/-0.000	50.800 +0.013/-0.000	47.625 +0.00/-1.52	55.37	4.76	BF03810-05080-04763-BA	Bushes - Aluminium Bronze - Flanged
38.100 +0.013/-0.000	50.800 +0.013/-0.000	47.625 +0.00/-1.52	55.37	4.76	BF03810-05080-04763-BAG	Bushes - Aluminium Bronze - Graphite Plug - Flanged
38.100 +0.013/-0.000	50.800 +0.013/-0.000	50.800 +0.00/-1.52			BP03810-05080-05080-BA	Bushes - Aluminium Bronze - Unflanged
38.100 +0.013/-0.000	50.800 +0.013/-0.000	50.800 +0.00/-1.52			BP03810-05080-05080-BAG	Bushes - Aluminium Bronze - Graphite Plug - Unflanged
38.100 +0.076/+0.102	50.800 +0.064/+0.102	50.800 +/-0.190			BP03810-05080-05080-BS	Bushes - Bronze - Sintered - Unflanged
38.100 +0.013/-0.000	50.800 +0.013/-0.000	60.325 +0.00/-1.52	55.37	4.76	BF03810-05080-06033-BA	Bushes - Aluminium Bronze - Flanged
38.100 +0.013/-0.000	50.800 +0.013/-0.000	60.325 +0.00/-1.52	55.37	4.76	BF03810-05080-06033-BAG	Bushes - Aluminium Bronze - Graphite Plug - Flanged
38.100 +0.076/+0.102	50.800 +0.064/+0.102	63.500 +/-0.190			BP03810-05080-06350-BS	Bushes - Bronze - Sintered - Unflanged
38.100 +/-0.0254	50.800 +0.0508/+0.0762	63.500 +/-0.127			BP03810-05080-06350-BC9	Bushes - Bronze - Solid - Leaded Gunmetal

 Stocked or Short Delivery

 Usually Available

 Long delivery or not in current production

ID	OD	B	DF	bf	Part Number	Type
----	----	---	----	----	-------------	------

38.100 x 50.800 mm (1.500 x 2.000 in.)						
38.100 +/-0.0254	50.800 +0.0508/+0.0762	63.500 +/-0.127			BP03810-05080-06350-BLG	Bushes - Bronze - Solid - Leaded Gunmetal
38.100 +0.013/-0.000	50.800 +0.013/-0.000	73.025 +0.00/-1.52	55.37	4.76	BF03810-05080-07303-BA	Bushes - Aluminium Bronze - Flanged
38.100 +0.013/-0.000	50.800 +0.013/-0.000	73.025 +0.00/-1.52	55.37	4.76	BF03810-05080-07303-BAG	Bushes - Aluminium Bronze - Graphite Plug - Flanged
38.100 +0.076/+0.102	50.800 +0.064/+0.102	76.200 +/-0.190			BP03810-05080-07620-BS	Bushes - Bronze - Sintered - Unflanged
38.100 +0.013/-0.000	50.800 +0.013/-0.000	76.200 +0.00/-1.52			BP03810-05080-07620-BA	Bushes - Aluminium Bronze - Unflanged
38.100 +0.013/-0.000	50.800 +0.013/-0.000	76.200 +0.00/-1.52			BP03810-05080-07620-BAG	Bushes - Aluminium Bronze - Graphite Plug - Unflanged
38.100 +/-0.0254	50.800 +0.0508/+0.0762	76.200 +/-0.127			BP03810-05080-07620-BC9	Bushes - Bronze - Solid - Leaded Gunmetal
38.100 +/-0.0254	50.800 +0.0508/+0.0762	76.200 +/-0.127			BP03810-05080-07620-BLG	Bushes - Bronze - Solid - Leaded Gunmetal
38.100 +0.013/-0.000	50.800 +0.013/-0.000	85.725 +0.00/-1.52	55.37	4.76	BF03810-05080-08573-BA	Bushes - Aluminium Bronze - Flanged
38.100 +0.013/-0.000	50.800 +0.013/-0.000	85.725 +0.00/-1.52	55.37	4.76	BF03810-05080-08573-BAG	Bushes - Aluminium Bronze - Graphite Plug - Flanged
38.100 +0.076/+0.102	50.800 +0.064/+0.102	88.900 +/-0.190			BP03810-05080-08890-BS	Bushes - Bronze - Sintered - Unflanged
38.100 +/-0.0254	50.800 +0.0508/+0.0762	88.900 +/-0.127			BP03810-05080-08890-BLG	Bushes - Bronze - Solid - Leaded Gunmetal
38.100 +0.013/-0.000	50.800 +0.013/-0.000	98.425 +0.00/-1.52	55.37	4.76	BF03810-05080-09843-BA	Bushes - Aluminium Bronze - Flanged
38.100 +0.013/-0.000	50.800 +0.013/-0.000	98.425 +0.00/-1.52	55.37	4.76	BF03810-05080-09843-BAG	Bushes - Aluminium Bronze - Graphite Plug - Flanged
38.100 +/-0.0254	50.800 +0.0508/+0.0762	101.600 +/-0.127			BP03810-05080-10160-BC9	Bushes - Bronze - Solid - Leaded Gunmetal
38.100 +/-0.0254	50.800 +0.0508/+0.0762	101.600 +/-0.127			BP03810-05080-10160-BLG	Bushes - Bronze - Solid - Leaded Gunmetal
38.100 +0.013/-0.000	50.800 +0.013/-0.000	111.125 +0.00/-1.52	55.37	4.76	BF03810-05080-11113-BA	Bushes - Aluminium Bronze - Flanged
38.100 +0.013/-0.000	50.800 +0.013/-0.000	111.125 +0.00/-1.52	55.37	4.76	BF03810-05080-11113-BAG	Bushes - Aluminium Bronze - Graphite Plug - Flanged
38.100 +0.013/-0.000	50.800 +0.013/-0.000	123.825 +0.00/-1.52	55.37	4.76	BF03810-05080-12383-BAG	Bushes - Aluminium Bronze - Graphite Plug - Flanged
38.100 +0.013/-0.000	50.800 +0.013/-0.000	123.825 +0.00/-1.52	55.37	4.76	BF03810-05080-12383-BA	Bushes - Aluminium Bronze - Flanged
38.100 +0.013/-0.000	50.800 +0.013/-0.000	149.225 +0.00/-1.52	55.37	4.76	BF03810-05080-14923-BA	Bushes - Aluminium Bronze - Flanged
38.100 +0.013/-0.000	50.800 +0.013/-0.000	149.225 +0.00/-1.52	55.37	4.76	BF03810-05080-14923-BAG	Bushes - Aluminium Bronze - Graphite Plug - Flanged

38.100 x 57.150 mm (1.500 x 2.250 in.)						
38.100 +/-0.0254	57.150 +0.0508/+0.0762	76.200 +/-0.127			BP03810-05715-07620-BC9	Bushes - Bronze - Solid - Leaded Gunmetal

40.000 x 44.000 mm (1.575 x 1.732 in.)						
40.000 -0.000/-0.050	44.000 +0.085/-0.000	12.000 +0.00/-0.40			BP04000-04400-01200-DP4	Bushes - Steel - DP4 - Split - Unflanged
40.000 -0.000/-0.050	44.000 +0.085/-0.000	12.000 +0.00/-0.40			BP04000-04400-01200-DU	Bushes - Steel - DU - Split - Unflanged
40.000 -0.000/-0.050	44.000 +0.085/-0.000	12.000 +0.00/-0.40			BP04000-04400-01200-SS6	Bushes - Stainless Steel and PTFE - Unflanged
40.000 -0.000/-0.025	44.000 +0.025/-0.000	16.000 +0.25/-0.25	53.00	2.00	BF04000-04400-01600-DP4	Bushes - Steel - DP4 - Split - Flanged
40.000 -0.000/-0.050	44.000 +0.085/-0.000	16.000 +0.25/-0.25	53.00	2.00	BF04000-04400-01600-DU	Bushes - Steel - DU - Split - Flanged
40.000 -0.000/-0.025	44.000 +0.025/-0.000	20.000 +0.25/-0.25			BP04000-04400-02000-DP4	Bushes - Steel - DP4 - Split - Unflanged
40.000 -0.000/-0.050	44.000 +0.085/-0.000	20.000 +0.00/-0.40			BP04000-04400-02000-DU	Bushes - Steel - DU - Split - Unflanged
40.000 -0.000/-0.050	44.000 +0.085/-0.000	20.000 +0.00/-0.40			BP04000-04400-02000-SS6	Bushes - Stainless Steel and PTFE - Unflanged
40.000 -0.000/-0.050	44.000 +0.085/-0.000	20.000 +0.25/-0.25			BP04000-04400-02000-DX	Bushes - Steel - DX - Split - Unflanged
40.000 -0.000/-0.050	44.000 +0.085/-0.000	25.000 +0.00/-0.40			BP04000-04400-02500-DP4	Bushes - Steel - DP4 - Split - Unflanged
40.000 -0.000/-0.050	44.000 +0.085/-0.000	25.000 +0.00/-0.40			BP04000-04400-02500-SS6	Bushes - Stainless Steel and PTFE - Unflanged
40.000 -0.000/-0.050	44.000 +0.085/-0.000	25.000 +0.00/-0.40			BP04000-04400-02500-DU	Bushes - Steel - DU - Split - Unflanged
40.000 -0.000/-0.050	44.000 +0.085/-0.000	26.000 +0.25/-0.25	53.00	1.80	BF04000-04400-02600-DUB	Bushes - Steel - DUB - Split - Flanged
40.000 -0.000/-0.050	44.000 +0.085/-0.000	26.000 +0.25/-0.25	53.00	2.00	BF04000-04400-02600-SS6	Bushes - Stainless Steel and PTFE - Flanged
40.000 -0.000/-0.025	44.000 +0.025/-0.000	26.000 +0.25/-0.25	53.00	2.00	BF04000-04400-02600-DP4	Bushes - Steel - DP4 - Split - Flanged

 Stocked or Short Delivery

 Usually Available

 Long delivery or not in current production

ID	OD	B	DF	bf	Part Number	Type
40.000 x 44.000 mm (1.575 x 1.732 in.)						
40.000 -0.000/-0.050	44.000 +0.085/-0.000	26.000 +0.25/-0.25	53.00	2.00	BF04000-04400-02600-DU	Bushes - Steel - DU - Split - Flanged
40.000 -0.000/-0.025	44.000 +0.025/-0.000	30.000 +0.25/-0.25			BP04000-04400-03000-DP4	Bushes - Steel - DP4 - Split - Unflanged
40.000 -0.000/-0.050	44.000 +0.085/-0.000	30.000 +0.00/-0.40			BP04000-04400-03000-DU	Bushes - Steel - DU - Split - Unflanged
40.000 -0.000/-0.050	44.000 +0.085/-0.000	30.000 +0.00/-0.40			BP04000-04400-03000-SS6	Bushes - Stainless Steel and PTFE - Unflanged
40.000 -0.000/-0.050	44.000 +0.085/-0.000	30.000 +0.25/-0.25			BP04000-04400-03000-DUB	Bushes - Steel - DUB - Split - Unflanged
40.000 -0.000/-0.050	44.000 +0.085/-0.000	30.000 +0.25/-0.25			BP04000-04400-03000-DX	Bushes - Steel - DX - Split - Unflanged
40.000 -0.000/-0.025	44.000 +0.025/-0.000	40.000 +0.25/-0.25			BP04000-04400-04000-DP4	Bushes - Steel - DP4 - Split - Unflanged
40.000 -0.000/-0.050	44.000 +0.085/-0.000	40.000 +0.00/-0.40			BP04000-04400-04000-DU	Bushes - Steel - DU - Split - Unflanged
40.000 -0.000/-0.050	44.000 +0.085/-0.000	40.000 +0.00/-0.40			BP04000-04400-04000-SS6	Bushes - Stainless Steel and PTFE - Unflanged
40.000 -0.000/-0.050	44.000 +0.085/-0.000	40.000 +0.25/-0.25			BP04000-04400-04000-DX	Bushes - Steel - DX - Split - Unflanged
40.000 -0.000/-0.050	44.000 +0.085/-0.000	40.000 +0.25/-0.25	53.00	2.00	BF04000-04400-04000-DU	Bushes - Steel - DU - Split - Flanged
40.000 -0.000/-0.050	44.000 +0.085/-0.000	40.000 +0.25/-0.25	53.00	2.00	BF04000-04400-04000-SS6	Bushes - Stainless Steel and PTFE - Flanged
40.000 -0.000/-0.050	44.000 +0.025/-0.000	40.000 +0.25/-0.25	53.00	2.00	BF04000-04400-04000-DP4	Bushes - Steel - DP4 - Split - Flanged
40.000 -0.000/-0.050	44.000 +0.085/-0.000	50.000 +0.00/-0.40			BP04000-04400-05000-SS6	Bushes - Stainless Steel and PTFE - Unflanged
40.000 -0.000/-0.025	44.000 +0.025/-0.000	50.000 +0.25/-0.25			BP04000-04400-05000-DP4	Bushes - Steel - DP4 - Split - Unflanged
40.000 -0.000/-0.050	44.000 +0.085/-0.000	50.000 +0.00/-0.40			BP04000-04400-05000-DU	Bushes - Steel - DU - Split - Unflanged
40.000 -0.000/-0.050	44.000 +0.085/-0.000	50.000 +0.25/-0.25			BP04000-04400-05000-DUB	Bushes - Steel - DUB - Split - Unflanged
40.000 -0.000/-0.050	44.000 +0.085/-0.000	50.000 +0.25/-0.25			BP04000-04400-05000-DX	Bushes - Steel - DX - Split - Unflanged
40.000 x 45.000 mm (1.575 x 1.772 in.)						
40.000 +/-0.0254	45.000 +0.0508/+0.0762	40.000 +/-0.127			BP04000-04500-04000-BLG	Bushes - Bronze - Solid - Leaded Gunmetal
40.000 +/-0.0254	45.000 +0.0508/+0.0762	50.000 +/-0.127			BP04000-04500-05000-BLG	Bushes - Bronze - Solid - Leaded Gunmetal
40.000 +/-0.0254	45.000 +0.0508/+0.0762	60.000 +/-0.127			BP04000-04500-06000-BLG	Bushes - Bronze - Solid - Leaded Gunmetal
40.000 +/-0.0254	45.000 +0.0508/+0.0762	80.000 +/-0.127			BP04000-04500-08000-BLG	Bushes - Bronze - Solid - Leaded Gunmetal
40.000 +/-0.0254	45.000 +0.0508/+0.0762	100.000 +/-0.127			BP04000-04500-10000-BLG	Bushes - Bronze - Solid - Leaded Gunmetal
40.000 x 46.000 mm (1.575 x 1.811 in.)						
40.000 +0.009/+0.034	46.000 +0.043/+0.068	30.000 +/-0.160			BP04000-04600-03000-BSO	Bushes - Bronze - Sintered - Unflanged - Oilite
40.000 +0.009/+0.034	46.000 +0.043/+0.068	40.000 +/-0.190			BP04000-04600-04000-BSO	Bushes - Bronze - Sintered - Unflanged - Oilite
40.000 +0.009/+0.034	46.000 +0.043/+0.068	50.000 +/-0.190			BP04000-04600-05000-BSO	Bushes - Bronze - Sintered - Unflanged - Oilite
40.000 x 50.000 mm (1.575 x 1.969 in.)						
40.000 +0.009/+0.034	50.000 +0.043/+0.068	25.000 +/-0.160			BP04000-05000-02500-BSO	Bushes - Bronze - Sintered - Unflanged - Oilite
40.000 +0.009/+0.048	50.000 +0.043/+0.082	25.000 +/-0.160	60.00	5.00	BF04000-05000-02500-BSO	Bushes - Bronze - Sintered - Flanged - Oilite
40.000 +0.009/+0.034	50.000 +0.043/+0.068	30.000 +/-0.160			BP04000-05000-03000-BSO	Bushes - Bronze - Sintered - Unflanged - Oilite
40.000 +0.009/+0.048	50.000 +0.043/+0.082	30.000 +/-0.160	60.00	5.00	BF04000-05000-03000-BSO	Bushes - Bronze - Sintered - Flanged - Oilite
40.000 +0.009/+0.034	50.000 +0.043/+0.068	35.000 +/-0.190			BP04000-05000-03500-BSO	Bushes - Bronze - Sintered - Unflanged - Oilite
40.000 +0.009/+0.034	50.000 +0.043/+0.068	40.000 +/-0.190			BP04000-05000-04000-BSO	Bushes - Bronze - Sintered - Unflanged - Oilite
40.000 +/-0.0254	50.000 +0.0508/+0.0762	40.000 +/-0.127			BP04000-05000-04000-BLG	Bushes - Bronze - Solid - Leaded Gunmetal
40.000 +0.009/+0.048	50.000 +0.043/+0.082	40.000 +/-0.190	60.00	5.00	BF04000-05000-04000-BSO	Bushes - Bronze - Sintered - Flanged - Oilite
40.000 +0.009/+0.034	50.000 +0.043/+0.068	50.000 +/-0.190			BP04000-05000-05000-BSO	Bushes - Bronze - Sintered - Unflanged - Oilite
40.000 +/-0.0254	50.000 +0.0508/+0.0762	50.000 +/-0.127			BP04000-05000-05000-BLG	Bushes - Bronze - Solid - Leaded Gunmetal
40.000 +0.009/+0.048	50.000 +0.043/+0.082	50.000 +/-0.190	60.00	5.00	BF04000-05000-05000-BSO	Bushes - Bronze - Sintered - Flanged - Oilite

 Stocked or Short Delivery

 Usually Available

 Long delivery or not in current production

ID	OD	B	DF	bf	Part Number	Type
40.000 x 50.000 mm (1.575 x 1.969 in.)						
40.000 +0.009/+0.034	50.000 +0.043/+0.068	60.000 +/-0.250			BP04000-05000-06000-BSO	Bushes - Bronze - Sintered - Unflanged - Oilite
40.000 +/-0.0254	50.000 +0.0508/+0.0762	60.000 +/-0.127			BP04000-05000-06000-BLG	Bushes - Bronze - Solid - Leaded Gunmetal
40.000 +/-0.0254	50.000 +0.0508/+0.0762	80.000 +/-0.127			BP04000-05000-08000-BLG	Bushes - Bronze - Solid - Leaded Gunmetal
40.000 +/-0.0254	50.000 +0.0508/+0.0762	100.000 +/-0.127			BP04000-05000-10000-BLG	Bushes - Bronze - Solid - Leaded Gunmetal
41.275 x 45.244 mm (1.625 x 1.781 in.)						
41.275 -0.000/-0.071	45.244 +0.014/-0.027	25.400 +0.00/-0.40			BP04128-04524-02540-DP4	Bushes - Steel - DP4 - Split - Unflanged
41.275 -0.000/-0.071	45.244 +0.014/-0.027	25.400 +0.00/-0.40			BP04128-04524-02540-DU	Bushes - Steel - DU - Split - Unflanged
41.275 -0.000/-0.071	45.244 +0.014/-0.027	25.400 +0.25/-0.25			BP04128-04524-02540-SS6	Bushes - Stainless Steel and PTFE - Unflanged
41.275 x 47.530 mm (1.625 x 1.871 in.)						
41.275 -0.000/-0.071	47.530 +0.014/-0.027	38.100 +0.00/-0.40			BP04128-04753-03810-DP4	Bushes - Steel - DP4 - Split - Unflanged
41.275 -0.000/-0.071	47.530 +0.014/-0.027	38.100 +0.00/-0.40			BP04128-04753-03810-DU	Bushes - Steel - DU - Split - Unflanged
41.275 -0.000/-0.071	47.530 +0.014/-0.027	38.100 +0.25/-0.25			BP04128-04753-03810-SS6	Bushes - Stainless Steel and PTFE - Unflanged
41.275 x 47.625 mm (1.625 x 1.875 in.)						
41.275 +0.064/+0.102	47.625 +0.064/+0.102	31.750 +/-0.127			BP04128-04763-03175-BS	Bushes - Bronze - Sintered - Unflanged
41.275 +0.064/+0.102	47.625 +0.064/+0.102	38.100 +/-0.127			BP04128-04763-03810-BS	Bushes - Bronze - Sintered - Unflanged
41.275 +0.064/+0.102	47.625 +0.064/+0.102	44.450 +/-0.190			BP04128-04763-04445-BS	Bushes - Bronze - Sintered - Unflanged
41.275 +0.064/+0.102	47.625 +0.064/+0.102	50.800 +/-0.190			BP04128-04763-05080-BS	Bushes - Bronze - Sintered - Unflanged
41.275 +0.064/+0.102	47.625 +0.064/+0.102	57.150 +/-0.190			BP04128-04763-05715-BS	Bushes - Bronze - Sintered - Unflanged
41.275 +0.064/+0.102	47.625 +0.064/+0.102	63.500 +/-0.190			BP04128-04763-06350-BS	Bushes - Bronze - Sintered - Unflanged
41.275 +0.064/+0.102	47.625 +0.064/+0.102	76.200 +/-0.190			BP04128-04763-07620-BS	Bushes - Bronze - Sintered - Unflanged
41.275 x 50.800 mm (1.625 x 2.000 in.)						
41.275 +0.064/+0.102	50.800 +0.064/+0.102	25.400 +/-0.127			BP04128-05080-02540-BS	Bushes - Bronze - Sintered - Unflanged
41.275 +0.064/+0.102	50.800 +0.064/+0.102	38.100 +/-0.127			BP04128-05080-03810-BS	Bushes - Bronze - Sintered - Unflanged
41.275 +0.064/+0.102	50.800 +0.064/+0.102	44.450 +/-0.190			BP04128-05080-04445-BS	Bushes - Bronze - Sintered - Unflanged
41.275 +0.064/+0.102	50.800 +0.064/+0.102	50.800 +/-0.190			BP04128-05080-05080-BS	Bushes - Bronze - Sintered - Unflanged
41.275 +0.064/+0.102	50.800 +0.064/+0.102	63.500 +/-0.190			BP04128-05080-06350-BS	Bushes - Bronze - Sintered - Unflanged
41.275 +0.064/+0.102	50.800 +0.064/+0.102	76.200 +/-0.190			BP04128-05080-07620-BS	Bushes - Bronze - Sintered - Unflanged
42.863 x 55.563 mm (1.688 x 2.188 in.)						
42.863 +0.076/+0.102	55.563 +0.089/+0.127	44.450 +/-0.190			BP04286-05556-04445-BS	Bushes - Bronze - Sintered - Unflanged
42.863 +0.076/+0.102	55.563 +0.089/+0.127	50.800 +/-0.190			BP04286-05556-05080-BS	Bushes - Bronze - Sintered - Unflanged
42.863 +0.076/+0.102	55.563 +0.089/+0.127	76.200 +/-0.190			BP04286-05556-07620-BS	Bushes - Bronze - Sintered - Unflanged
42.863 +0.076/+0.102	55.563 +0.089/+0.127	101.600 +/-0.254			BP04286-05556-10160-BS	Bushes - Bronze - Sintered - Unflanged
44.450 x 49.213 mm (1.750 x 1.938 in.)						
44.450 -0.000/-0.074	49.213 +0.015/-0.010	25.400 +0.00/-0.40			BP04445-04921-02540-DP4	Bushes - Steel - DP4 - Split - Unflanged
44.450 -0.000/-0.074	49.213 +0.015/-0.010	25.400 +0.00/-0.40			BP04445-04921-02540-DU	Bushes - Steel - DU - Split - Unflanged
44.450 -0.000/-0.074	49.213 +0.015/-0.010	25.400 +0.25/-0.25			BP04445-04921-02540-SS6	Bushes - Stainless Steel and PTFE - Unflanged
44.450 -0.000/-0.030	49.213 +0.015/-0.010	25.400 +0.25/-0.25	60.83	2.49	BF04445-04921-02540-SS6	Bushes - Stainless Steel and PTFE - Flanged
44.450 -0.000/-0.041	49.213 +0.015/-0.010	25.400 +0.25/-0.25	60.83	2.49	BF04445-04921-02540-DU	Bushes - Steel - DU - Split - Flanged
44.450 -0.000/-0.041	49.213 +0.015/-0.010	25.400 +0.25/-0.25	60.83	2.49	BF04445-04921-02540-DP4	Bushes - Steel - DP4 - Split - Flanged

 Stocked or Short Delivery

 Usually Available

 Long delivery or not in current production

ID	OD	B	DF	bf	Part Number	Type
----	----	---	----	----	-------------	------

44.450 x 49.213 mm (1.750 x 1.938 in.)						
44.450 -0.000/-0.074	49.213 +0.015/-0.010	38.100 +0.00/-0.40			BP04445-04921-03810-DP4	Bushes - Steel - DP4 - Split - Unflanged
44.450 -0.000/-0.074	49.213 +0.015/-0.010	38.100 +0.25/-0.25			BP04445-04921-03810-SS6	Bushes - Stainless Steel and PTFE - Unflanged
44.450 -0.000/-0.074	49.213 +0.015/-0.010	38.100 +0.00/-0.40			BP04445-04921-03810-DU	Bushes - Steel - DU - Split - Unflanged
44.450 -0.000/-0.041	49.213 +0.015/-0.010	38.100 +0.25/-0.25	60.83	2.49	BF04445-04921-03810-DP4	Bushes - Steel - DP4 - Split - Flanged
44.450 -0.000/-0.041	49.213 +0.015/-0.010	38.100 +0.25/-0.25	60.83	2.49	BF04445-04921-03810-DU	Bushes - Steel - DU - Split - Flanged
44.450 -0.000/-0.030	49.213 +0.015/-0.010	38.100 +0.25/-0.25	60.83	2.49	BF04445-04921-03810-SS6	Bushes - Stainless Steel and PTFE - Flanged
44.450 -0.000/-0.074	49.213 +0.015/-0.010	50.800 +0.00/-0.40			BP04445-04921-05080-DP4	Bushes - Steel - DP4 - Split - Unflanged
44.450 -0.000/-0.074	49.213 +0.015/-0.010	50.800 +0.00/-0.40			BP04445-04921-05080-DU	Bushes - Steel - DU - Split - Unflanged
44.450 -0.000/-0.074	49.213 +0.015/-0.010	50.800 +0.25/-0.25			BP04445-04921-05080-SS6	Bushes - Stainless Steel and PTFE - Unflanged
44.450 -0.000/-0.030	49.213 +0.015/-0.010	50.800 +0.25/-0.25	60.83	2.49	BF04445-04921-05080-SS6	Bushes - Stainless Steel and PTFE - Flanged
44.450 -0.000/-0.041	49.213 +0.015/-0.010	50.800 +0.25/-0.25	60.83	2.49	BF04445-04921-05080-DU	Bushes - Steel - DU - Split - Flanged
44.450 -0.000/-0.041	49.213 +0.015/-0.010	50.800 +0.25/-0.25	60.83	2.49	BF04445-04921-05080-DP4	Bushes - Steel - DP4 - Split - Flanged

44.450 x 50.800 mm (1.750 x 2.000 in.)						
44.450 +0.076/+0.102	50.800 +0.064/+0.102	25.400 +/-0.127			BP04445-05080-02540-BS	Bushes - Bronze - Sintered - Unflanged
44.450 +0.076/+0.102	50.800 +0.064/+0.102	31.750 +/-0.127			BP04445-05080-03175-BS	Bushes - Bronze - Sintered - Unflanged
44.450 +0.076/+0.102	50.800 +0.064/+0.102	38.100 +/-0.127			BP04445-05080-03810-BS	Bushes - Bronze - Sintered - Unflanged
44.450 +0.076/+0.102	50.800 +0.064/+0.102	44.450 +/-0.190			BP04445-05080-04445-BS	Bushes - Bronze - Sintered - Unflanged
44.450 +0.076/+0.102	50.800 +0.064/+0.102	50.800 +/-0.190			BP04445-05080-05080-BS	Bushes - Bronze - Sintered - Unflanged
44.450 +0.076/+0.102	50.800 +0.064/+0.102	63.500 +/-0.190			BP04445-05080-06350-BS	Bushes - Bronze - Sintered - Unflanged
44.450 +/-0.0254	50.800 +0.0508/+0.0762	63.500 +/-0.127			BP04445-05080-06350-BLG	Bushes - Bronze - Solid - Leaded Gunmetal
44.450 +0.076/+0.102	50.800 +0.064/+0.102	76.200 +/-0.190			BP04445-05080-07620-BS	Bushes - Bronze - Sintered - Unflanged
44.450 +/-0.0254	50.800 +0.0508/+0.0762	76.200 +/-0.127			BP04445-05080-07620-BC9	Bushes - Bronze - Solid - Leaded Gunmetal
44.450 +/-0.0254	50.800 +0.0508/+0.0762	76.200 +/-0.127			BP04445-05080-07620-BLG	Bushes - Bronze - Solid - Leaded Gunmetal
44.450 +/-0.0254	50.800 +0.0508/+0.0762	88.900 +/-0.127			BP04445-05080-08890-BLG	Bushes - Bronze - Solid - Leaded Gunmetal
44.450 +/-0.0254	50.800 +0.0508/+0.0762	101.600 +/-0.127			BP04445-05080-10160-BLG	Bushes - Bronze - Solid - Leaded Gunmetal

44.450 x 53.975 mm (1.750 x 2.125 in.)						
44.450 +0.076/+0.102	53.975 +0.064/+0.102	34.925 +/-0.127			BP04445-05398-03493-BS	Bushes - Bronze - Sintered - Unflanged
44.450 +0.076/+0.102	53.975 +0.064/+0.102	38.100 +/-0.127			BP04445-05398-03810-BS	Bushes - Bronze - Sintered - Unflanged
44.450 +0.076/+0.102	53.975 +0.064/+0.102	50.800 +/-0.190			BP04445-05398-05080-BS	Bushes - Bronze - Sintered - Unflanged
44.450 +0.102/+0.127	53.975 +0.038/+0.076	63.500 +/-0.190			BP04445-05398-06350-BS	Bushes - Bronze - Sintered - Unflanged
44.450 +0.076/+0.102	53.975 +0.064/+0.102	76.200 +/-0.190			BP04445-05398-07620-BS	Bushes - Bronze - Sintered - Unflanged
44.450 +/-0.0254	53.975 +0.0508/+0.0762	101.600 +/-0.127			BP04445-05398-10160-BLG	Bushes - Bronze - Solid - Leaded Gunmetal

44.450 x 57.150 mm (1.750 x 2.250 in.)						
44.450 +/-0.0254	57.150 +0.0508/+0.0762	44.450 +/-0.127			BP04445-05715-04445-BC9	Bushes - Bronze - Solid - Leaded Gunmetal
44.450 +/-0.0254	57.150 +0.0508/+0.0762	57.150 +/-0.127			BP04445-05715-05715-BLG	Bushes - Bronze - Solid - Leaded Gunmetal
44.450 +0.050/+0.076	57.150 +0.064/+0.102	63.500 +/-0.190	76.20	6.35	BF04445-05715-06350-BS	Bushes - Bronze - Sintered - Flanged
44.450 +/-0.0254	57.150 +0.0508/+0.0762	76.200 +/-0.127			BP04445-05715-07620-BLG	Bushes - Bronze - Solid - Leaded Gunmetal
44.450 +/-0.0254	57.150 +0.0508/+0.0762	88.900 +/-0.127			BP04445-05715-08890-BLG	Bushes - Bronze - Solid - Leaded Gunmetal

44.450 x 63.500 mm (1.750 x 2.500 in.)						
44.450 +/-0.0254	63.500 +0.0508/+0.0762	101.600 +/-0.127			BP04445-06350-10160-BLG	Bushes - Bronze - Solid - Leaded Gunmetal

 Stocked or Short Delivery

 Usually Available

 Long delivery or not in current production

ID	OD	B	DF	bf	Part Number	Type
45.000 x 50.000 mm (1.772 x 1.969 in.)						
45.000 -0.000/-0.025	50.000 +0.025/-0.000	16.000 +0.25/-0.25	58.00	2.00	BF04500-05000-01600-DU	Bushes - Steel - DU - Split - Flanged
45.000 -0.000/-0.025	50.000 +0.025/-0.000	16.000 +0.25/-0.25	58.00	2.00	BF04500-05000-01600-DP4	Bushes - Steel - DP4 - Split - Flanged
45.000 -0.000/-0.050	50.000 +0.085/-0.000	20.000 +0.00/-0.40			BP04500-05000-02000-SS6	Bushes - Stainless Steel and PTFE - Unflanged
45.000 -0.000/-0.025	50.000 +0.025/-0.000	20.000 +0.25/-0.25			BP04500-05000-02000-DP4	Bushes - Steel - DP4 - Split - Unflanged
45.000 -0.000/-0.050	50.000 +0.085/-0.000	20.000 +0.00/-0.40			BP04500-05000-02000-DU	Bushes - Steel - DU - Split - Unflanged
45.000 -0.000/-0.050	50.000 +0.085/-0.000	20.000 +0.25/-0.25			BP04500-05000-02000-DX	Bushes - Steel - DX - Split - Unflanged
45.000 -0.000/-0.050	50.000 +0.085/-0.000	25.000 +0.00/-0.40			BP04500-05000-02500-DU	Bushes - Steel - DU - Split - Unflanged
45.000 -0.000/-0.050	50.000 +0.085/-0.000	25.000 +0.00/-0.40			BP04500-05000-02500-SS6	Bushes - Stainless Steel and PTFE - Unflanged
45.000 -0.000/-0.050	50.000 +0.085/-0.000	25.000 +0.00/-0.40			BP04500-05000-02500-DP4	Bushes - Steel - DP4 - Split - Unflanged
45.000 -0.000/-0.025	50.000 +0.025/-0.000	26.000 +0.25/-0.25	58.00	2.00	BF04500-05000-02600-DU	Bushes - Steel - DU - Split - Flanged
45.000 -0.000/-0.025	50.000 +0.025/-0.000	26.000 +0.25/-0.25	58.00	2.00	BF04500-05000-02600-DP4	Bushes - Steel - DP4 - Split - Flanged
45.000 -0.000/-0.025	50.000 +0.025/-0.000	26.000 +0.25/-0.25	58.00	2.40	BF04500-05000-02600-DUB	Bushes - Steel - DUB - Split - Flanged
45.000 -0.000/-0.050	50.000 +0.085/-0.000	30.000 +0.00/-0.40			BP04500-05000-03000-SS6	Bushes - Stainless Steel and PTFE - Unflanged
45.000 -0.000/-0.025	50.000 +0.025/-0.000	30.000 +0.25/-0.25			BP04500-05000-03000-DP4	Bushes - Steel - DP4 - Split - Unflanged
45.000 -0.000/-0.050	50.000 +0.085/-0.000	30.000 +0.00/-0.40			BP04500-05000-03000-DU	Bushes - Steel - DU - Split - Unflanged
45.000 -0.000/-0.050	50.000 +0.085/-0.000	30.000 +0.25/-0.25			BP04500-05000-03000-DUB	Bushes - Steel - DUB - Split - Unflanged
45.000 -0.000/-0.050	50.000 +0.085/-0.000	30.000 +0.25/-0.25			BP04500-05000-03000-DX	Bushes - Steel - DX - Split - Unflanged
45.000 -0.000/-0.050	50.000 +0.085/-0.000	40.000 +0.00/-0.40			BP04500-05000-04000-DU	Bushes - Steel - DU - Split - Unflanged
45.000 -0.000/-0.050	50.000 +0.085/-0.000	40.000 +0.00/-0.40			BP04500-05000-04000-SS6	Bushes - Stainless Steel and PTFE - Unflanged
45.000 -0.000/-0.025	50.000 +0.025/-0.000	40.000 +0.25/-0.25			BP04500-05000-04000-DP4	Bushes - Steel - DP4 - Split - Unflanged
45.000 -0.000/-0.050	50.000 +0.085/-0.000	40.000 +0.25/-0.25			BP04500-05000-04000-DX	Bushes - Steel - DX - Split - Unflanged
45.000 -0.000/-0.025	50.000 +0.025/-0.000	45.000 +0.25/-0.25			BP04500-05000-04500-DP4	Bushes - Steel - DP4 - Split - Unflanged
45.000 -0.000/-0.050	50.000 +0.085/-0.000	45.000 +0.25/-0.25			BP04500-05000-04500-DU	Bushes - Steel - DU - Split - Unflanged
45.000 -0.000/-0.050	50.000 +0.085/-0.000	45.000 +0.25/-0.25			BP04500-05000-04500-DX	Bushes - Steel - DX - Split - Unflanged
45.000 -0.000/-0.050	50.000 +0.085/-0.000	50.000 +0.00/-0.40			BP04500-05000-05000-SS6	Bushes - Stainless Steel and PTFE - Unflanged
45.000 -0.000/-0.025	50.000 +0.025/-0.000	50.000 +0.25/-0.25			BP04500-05000-05000-DP4	Bushes - Steel - DP4 - Split - Unflanged
45.000 -0.000/-0.050	50.000 +0.085/-0.000	50.000 +0.00/-0.40			BP04500-05000-05000-DU	Bushes - Steel - DU - Split - Unflanged
45.000 -0.000/-0.050	50.000 +0.085/-0.000	50.000 +0.25/-0.25			BP04500-05000-05000-DUB	Bushes - Steel - DUB - Split - Unflanged
45.000 -0.000/-0.050	50.000 +0.085/-0.000	50.000 +0.25/-0.25			BP04500-05000-05000-DX	Bushes - Steel - DX - Split - Unflanged
45.000 x 51.000 mm (1.772 x 2.008 in.)						
45.000 +0.009/+0.048	51.000 +0.053/+0.099	35.000 +/-0.190			BP04500-05100-03500-BSO	Bushes - Bronze - Sintered - Unflanged - Oilite
45.000 +0.009/+0.048	51.000 +0.053/+0.099	45.000 +/-0.190			BP04500-05100-04500-BSO	Bushes - Bronze - Sintered - Unflanged - Oilite
45.000 +0.009/+0.048	51.000 +0.053/+0.099	55.000 +/-0.250			BP04500-05100-05500-BSO	Bushes - Bronze - Sintered - Unflanged - Oilite
45.000 x 55.000 mm (1.772 x 2.165 in.)						
45.000 +0.009/+0.048	55.000 +0.053/+0.099	35.000 +/-0.190			BP04500-05500-03500-BSO	Bushes - Bronze - Sintered - Unflanged - Oilite
45.000 +0.009/+0.048	55.000 +0.053/+0.099	45.000 +/-0.190			BP04500-05500-04500-BSO	Bushes - Bronze - Sintered - Unflanged - Oilite
45.000 +/-0.0254	55.000 +0.0508/+0.0762	50.000 +/-0.127			BP04500-05500-05000-BLG	Bushes - Bronze - Solid - Leaded Gunmetal
45.000 +0.009/+0.048	55.000 +0.053/+0.099	55.000 +/-0.250			BP04500-05500-05500-BSO	Bushes - Bronze - Sintered - Unflanged - Oilite
45.000 +/-0.0254	55.000 +0.0508/+0.0762	60.000 +/-0.127			BP04500-05500-06000-BLG	Bushes - Bronze - Solid - Leaded Gunmetal
45.000 +/-0.0254	55.000 +0.0508/+0.0762	80.000 +/-0.127			BP04500-05500-08000-BLG	Bushes - Bronze - Solid - Leaded Gunmetal

 Stocked or Short Delivery

 Usually Available

 Long delivery or not in current production

ID	OD	B	DF	bf	Part Number	Type
45.000 x 55.000 mm (1.772 x 2.165 in.)						
45.000 +/-0.0254	55.000 +0.0508/+0.0762	100.000 +/-0.127			BP04500-05500-10000-BLG	Bushes - Bronze - Solid - Leaded Gunmetal
47.625 x 52.324 mm (1.875 x 2.060 in.)						
47.625 -0.000/-0.074	52.324 +0.020/-0.010	19.050 +0.25/-0.25			BP04763-05232-01905-SS6	Bushes - Stainless Steel and PTFE - Unflanged
47.625 -0.000/-0.074	52.324 +0.020/-0.010	19.050 +0.00/-0.40			BP04763-05232-01905-DU	Bushes - Steel - DU - Split - Unflanged
47.625 -0.000/-0.074	52.324 +0.020/-0.010	19.050 +0.00/-0.40			BP04763-05232-01905-DP4	Bushes - Steel - DP4 - Split - Unflanged
47.625 -0.000/-0.074	52.324 +0.020/-0.010	25.400 +0.00/-0.40			BP04763-05232-02540-DP4	Bushes - Steel - DP4 - Split - Unflanged
47.625 -0.000/-0.074	52.324 +0.020/-0.010	25.400 +0.00/-0.40			BP04763-05232-02540-DU	Bushes - Steel - DU - Split - Unflanged
47.625 -0.000/-0.074	52.324 +0.020/-0.010	25.400 +0.25/-0.25			BP04763-05232-02540-SS6	Bushes - Stainless Steel and PTFE - Unflanged
47.625 -0.000/-0.074	52.324 +0.020/-0.010	57.150 +0.00/-0.40			BP04763-05232-05715-DP4	Bushes - Steel - DP4 - Split - Unflanged
47.625 -0.000/-0.074	52.324 +0.020/-0.010	57.150 +0.00/-0.40			BP04763-05232-05715-DU	Bushes - Steel - DU - Split - Unflanged
47.625 -0.000/-0.074	52.324 +0.020/-0.010	57.150 +0.25/-0.25			BP04763-05232-05715-SS6	Bushes - Stainless Steel and PTFE - Unflanged
49.213 x 53.975 mm (1.938 x 2.125 in.)						
49.213 +0.076/+0.038	53.975 +0.051/+0.089	63.500 +/-0.190			BP04921-05398-06350-BS	Bushes - Bronze - Sintered - Unflanged
49.213 x 58.738 mm (1.938 x 2.313 in.)						
49.213 +0.050/+0.088	58.738 +0.064/+0.102	50.800 +/-0.190			BP04921-05874-05080-BS	Bushes - Bronze - Sintered - Unflanged
49.213 +0.050/+0.088	58.738 +0.064/+0.102	63.500 +/-0.190			BP04921-05874-06350-BS	Bushes - Bronze - Sintered - Unflanged
49.213 +0.050/+0.088	58.738 +0.064/+0.102	76.200 +/-0.190			BP04921-05874-07620-BS	Bushes - Bronze - Sintered - Unflanged
49.213 +0.050/+0.088	58.738 +0.064/+0.102	101.600 +/-0.254			BP04921-05874-10160-BS	Bushes - Bronze - Sintered - Unflanged
50.000 x 55.000 mm (1.969 x 2.165 in.)						
50.000 -0.000/-0.050	55.000 +0.100/-0.000	20.000 +0.00/-0.40			BP05000-05500-02000-DU	Bushes - Steel - DU - Split - Unflanged
50.000 -0.000/-0.050	55.000 +0.100/-0.000	20.000 +0.00/-0.40			BP05000-05500-02000-SS6	Bushes - Stainless Steel and PTFE - Unflanged
50.000 -0.000/-0.025	55.000 +0.030/-0.000	20.000 +0.25/-0.25			BP05000-05500-02000-DP4	Bushes - Steel - DP4 - Split - Unflanged
50.000 -0.000/-0.025	55.000 +0.030/-0.000	30.000 +0.25/-0.25			BP05000-05500-03000-DP4	Bushes - Steel - DP4 - Split - Unflanged
50.000 -0.000/-0.050	55.000 +0.100/-0.000	30.000 +0.00/-0.40			BP05000-05500-03000-DU	Bushes - Steel - DU - Split - Unflanged
50.000 -0.000/-0.050	55.000 +0.100/-0.000	30.000 +0.00/-0.40			BP05000-05500-03000-SS6	Bushes - Stainless Steel and PTFE - Unflanged
50.000 -0.000/-0.050	55.000 +0.100/-0.000	40.000 +0.00/-0.40			BP05000-05500-04000-SS6	Bushes - Stainless Steel and PTFE - Unflanged
50.000 -0.000/-0.025	55.000 +0.030/-0.000	40.000 +0.25/-0.25			BP05000-05500-04000-DP4	Bushes - Steel - DP4 - Split - Unflanged
50.000 -0.000/-0.050	55.000 +0.100/-0.000	40.000 +0.00/-0.40			BP05000-05500-04000-DU	Bushes - Steel - DU - Split - Unflanged
50.000 -0.000/-0.050	55.000 +0.100/-0.000	40.000 +0.25/-0.25			BP05000-05500-04000-DUB	Bushes - Steel - DUB - Split - Unflanged
50.000 -0.000/-0.050	55.000 +0.100/-0.000	40.000 +0.25/-0.25			BP05000-05500-04000-DX	Bushes - Steel - DX - Split - Unflanged
50.000 -0.000/-0.050	55.000 +0.100/-0.000	50.000 +0.00/-0.40			BP05000-05500-05000-DU	Bushes - Steel - DU - Split - Unflanged
50.000 -0.000/-0.050	55.000 +0.100/-0.000	50.000 +0.00/-0.40			BP05000-05500-05000-SS6	Bushes - Stainless Steel and PTFE - Unflanged
50.000 -0.000/-0.025	55.000 +0.030/-0.000	50.000 +0.25/-0.25			BP05000-05500-05000-DP4	Bushes - Steel - DP4 - Split - Unflanged
50.000 -0.000/-0.050	55.000 +0.100/-0.000	50.000 +0.25/-0.25			BP05000-05500-05000-DX	Bushes - Steel - DX - Split - Unflanged
50.000 -0.000/-0.050	55.000 +0.100/-0.000	60.000 +0.00/-0.40			BP05000-05500-06000-DU	Bushes - Steel - DU - Split - Unflanged
50.000 -0.000/-0.025	55.000 +0.030/-0.000	60.000 +0.25/-0.25			BP05000-05500-06000-DP4	Bushes - Steel - DP4 - Split - Unflanged
50.000 -0.000/-0.050	55.000 +0.100/-0.000	60.000 +0.00/-0.40			BP05000-05500-06000-SS6	Bushes - Stainless Steel and PTFE - Unflanged
50.000 -0.000/-0.050	55.000 +0.100/-0.000	60.000 +0.25/-0.25			BP05000-05500-06000-DUB	Bushes - Steel - DUB - Split - Unflanged
50.000 -0.000/-0.050	55.000 +0.100/-0.000	60.000 +0.25/-0.25			BP05000-05500-06000-DX	Bushes - Steel - DX - Split - Unflanged

Stocked or Short Delivery

Usually Available

Long delivery or not in current production

ID	OD	B	DF	bf	Part Number	Type
50.000 x 60.000 mm (1.969 x 2.362 in.)						
50.000 +0.009/+0.048	60.000 +0.053/+0.099	30.000 +/-0.160			BP05000-06000-03000-BSO	Bushes - Bronze - Sintered - Unflanged - Oilite
50.000 +0.009/+0.048	60.000 +0.053/+0.099	32.000 +/-0.190	70.00	5.00	BF05000-06000-03200-BSO	Bushes - Bronze - Sintered - Flanged - Oilite
50.000 +0.009/+0.048	60.000 +0.053/+0.099	35.000 +/-0.190			BP05000-06000-03500-BSO	Bushes - Bronze - Sintered - Unflanged - Oilite
50.000 +0.009/+0.048	60.000 +0.053/+0.099	40.000 +/-0.190			BP05000-06000-04000-BSO	Bushes - Bronze - Sintered - Unflanged - Oilite
50.000 +0.009/+0.048	60.000 +0.053/+0.099	40.000 +/-0.190	70.00	5.00	BF05000-06000-04000-BSO	Bushes - Bronze - Sintered - Flanged - Oilite
50.000 +0.009/+0.048	60.000 +0.053/+0.099	50.000 +/-0.190			BP05000-06000-05000-BSO	Bushes - Bronze - Sintered - Unflanged - Oilite
50.000 +/-0.0254	60.000 +0.0508/+0.0762	50.000 +/-0.127			BP05000-06000-05000-BLG	Bushes - Bronze - Solid - Leaded Gunmetal
50.000 +0.009/+0.048	60.000 +0.053/+0.099	50.000 +/-0.190	70.00	5.00	BF05000-06000-05000-BSO	Bushes - Bronze - Sintered - Flanged - Oilite
50.000 +/-0.0254	60.000 +0.0508/+0.0762	60.000 +/-0.127			BP05000-06000-06000-BLG	Bushes - Bronze - Solid - Leaded Gunmetal
50.000 +/-0.0254	60.000 +0.0508/+0.0762	80.000 +/-0.127			BP05000-06000-08000-BLG	Bushes - Bronze - Solid - Leaded Gunmetal
50.000 +/-0.0254	60.000 +0.0508/+0.0762	100.000 +/-0.127			BP05000-06000-10000-BLG	Bushes - Bronze - Solid - Leaded Gunmetal

50.800 x 55.499 mm (2.000 x 2.185 in.)						
50.800 -0.000/-0.079	55.499 +0.020/-0.010	12.700 +0.00/-0.40			BP05080-05550-01270-DP4	Bushes - Steel - DP4 - Split - Unflanged
50.800 -0.000/-0.079	55.499 +0.020/-0.010	12.700 +0.00/-0.40			BP05080-05550-01270-DU	Bushes - Steel - DU - Split - Unflanged
50.800 -0.000/-0.079	55.499 +0.020/-0.010	12.700 +0.25/-0.25			BP05080-05550-01270-SS6	Bushes - Stainless Steel and PTFE - Unflanged
50.800 -0.000/-0.079	55.499 +0.020/-0.010	25.400 +0.00/-0.40			BP05080-05550-02540-DU	Bushes - Steel - DU - Split - Unflanged
50.800 -0.000/-0.079	55.499 +0.020/-0.010	25.400 +0.25/-0.25			BP05080-05550-02540-SS6	Bushes - Stainless Steel and PTFE - Unflanged
50.800 -0.000/-0.079	55.499 +0.020/-0.010	25.400 +0.00/-0.40			BP05080-05550-02540-DP4	Bushes - Steel - DP4 - Split - Unflanged
50.800 -0.000/-0.079	55.499 +0.020/-0.010	38.100 +0.00/-0.40			BP05080-05550-03810-DU	Bushes - Steel - DU - Split - Unflanged
50.800 -0.000/-0.079	55.499 +0.020/-0.010	38.100 +0.25/-0.25			BP05080-05550-03810-SS6	Bushes - Stainless Steel and PTFE - Unflanged
50.800 -0.000/-0.079	55.499 +0.020/-0.010	38.100 +0.00/-0.40			BP05080-05550-03810-DP4	Bushes - Steel - DP4 - Split - Unflanged
50.800 -0.000/-0.079	55.499 +0.020/-0.010	44.450 +0.00/-0.40			BP05080-05550-04445-DP4	Bushes - Steel - DP4 - Split - Unflanged
50.800 -0.000/-0.079	55.499 +0.020/-0.010	44.450 +0.00/-0.40			BP05080-05550-04445-DU	Bushes - Steel - DU - Split - Unflanged
50.800 -0.000/-0.079	55.499 +0.020/-0.010	44.450 +0.25/-0.25			BP05080-05550-04445-SS6	Bushes - Stainless Steel and PTFE - Unflanged
50.800 -0.000/-0.079	55.499 +0.020/-0.010	50.800 +0.00/-0.40			BP05080-05550-05080-DU	Bushes - Steel - DU - Split - Unflanged
50.800 -0.000/-0.079	55.499 +0.020/-0.010	50.800 +0.00/-0.40			BP05080-05550-05080-DP4	Bushes - Steel - DP4 - Split - Unflanged
50.800 -0.000/-0.079	55.499 +0.020/-0.010	50.800 +0.25/-0.25			BP05080-05550-05080-SS6	Bushes - Stainless Steel and PTFE - Unflanged
50.800 -0.000/-0.079	55.499 +0.020/-0.010	63.500 +0.00/-0.40			BP05080-05550-06350-DP4	Bushes - Steel - DP4 - Split - Unflanged
50.800 -0.000/-0.079	55.499 +0.020/-0.010	63.500 +0.00/-0.40			BP05080-05550-06350-DU	Bushes - Steel - DU - Split - Unflanged
50.800 -0.000/-0.079	55.499 +0.020/-0.010	63.500 +0.25/-0.25			BP05080-05550-06350-SS6	Bushes - Stainless Steel and PTFE - Unflanged

50.800 x 57.150 mm (2.000 x 2.250 in.)						
50.800 +0.0762/+0.1016	57.150 +0.0889/+0.1270	25.400 +0.127/-0.127			BP05080-05715-02540-BS	Bushes - Bronze - Sintered - Unflanged
50.800 +0.0762/+0.1016	57.150 +0.0889/+0.1270	25.400 +0.127/-0.127			BP05080-05715-02540-BFG	Bushes - Bronze - Sintered - ECO841 Food Grade - Unflanged
50.800 +0.0762/+0.1016	57.150 +0.0889/+0.1270	38.100 +0.190/-0.190			BP05080-05715-03810-BS	Bushes - Bronze - Sintered - Unflanged
50.800 +0.0762/+0.1016	57.150 +0.0889/+0.1270	38.100 +0.190/-0.190			BP05080-05715-03810-BFG	Bushes - Bronze - Sintered - ECO841 Food Grade - Unflanged
50.800 +0.0762/+0.1016	57.150 +0.0889/+0.1270	50.800 +0.190/-0.190			BP05080-05715-05080-BS	Bushes - Bronze - Sintered - Unflanged
50.800 +0.0762/+0.1016	57.150 +0.0889/+0.1270	50.800 +0.190/-0.190			BP05080-05715-05080-BFG	Bushes - Bronze - Sintered - ECO841 Food Grade - Unflanged
50.800 +/-0.0254	57.150 +0.0508/+0.0762	50.800 +/-0.127			BP05080-05715-05080-BC9	Bushes - Bronze - Solid - Leaded Gunmetal
50.800 +0.064/+0.102	57.150 +0.064/+0.102	63.500 +/-0.190			BP05080-05715-06350-BS	Bushes - Bronze - Sintered - Unflanged

 Stocked or Short Delivery

 Usually Available

 Long delivery or not in current production

ID	OD	B	DF	bf	Part Number	Type
50.800 x 57.150 mm (2.000 x 2.250 in.)						
50.800 +/-0.0254	57.150 +0.0508/+0.0762	63.500 +/-0.127			BP05080-05715-06350-BLG	Bushes - Bronze - Solid - Leaded Gunmetal
50.800 +0.064/+0.102	57.150 +0.064/+0.102	76.200 +/-0.190			BP05080-05715-07620-BS	Bushes - Bronze - Sintered - Unflanged
50.800 +/-0.0254	57.150 +0.0508/+0.0762	76.200 +/-0.127			BP05080-05715-07620-BLG	Bushes - Bronze - Solid - Leaded Gunmetal
50.800 +/-0.0254	57.150 +0.0508/+0.0762	88.900 +/-0.127			BP05080-05715-08890-BLG	Bushes - Bronze - Solid - Leaded Gunmetal
50.800 x 60.325 mm (2.000 x 2.375 in.)						
50.800 +0.064/+0.102	60.325 +0.089/+0.127	38.100 +/-0.127			BP05080-06033-03810-BS	Bushes - Bronze - Sintered - Unflanged
50.800 +0.0762/+0.1016	60.325 +0.0889/+0.1270	38.100 +0.190/-0.190			BP05080-06033-03810-BFG	Bushes - Bronze - Sintered - ECO841 Food Grade - Unflanged
50.800 +0.064/+0.102	60.325 +0.089/+0.127	44.450 +/-0.190			BP05080-06033-04445-BS	Bushes - Bronze - Sintered - Unflanged
50.800 +0.064/+0.102	60.325 +0.089/+0.127	50.800 +/-0.190			BP05080-06033-05080-BS	Bushes - Bronze - Sintered - Unflanged
50.800 +0.0762/+0.1016	60.325 +0.0889/+0.1270	50.800 +0.190/-0.190			BP05080-06033-05080-BFG	Bushes - Bronze - Sintered - ECO841 Food Grade - Unflanged
50.800 +0.064/+0.102	60.325 +0.089/+0.127	63.500 +/-0.190			BP05080-06033-06350-BS	Bushes - Bronze - Sintered - Unflanged
50.800 +0.064/+0.102	60.325 +0.089/+0.127	69.850 +/-0.190			BP05080-06033-06985-BS	Bushes - Bronze - Sintered - Unflanged
50.800 +0.064/+0.102	60.325 +0.089/+0.127	76.200 +/-0.190			BP05080-06033-07620-BS	Bushes - Bronze - Sintered - Unflanged
50.800 +/-0.0254	60.325 +0.0508/+0.0762	76.200 +/-0.127			BP05080-06033-07620-BC9	Bushes - Bronze - Solid - Leaded Gunmetal
50.800 +0.064/+0.102	60.325 +0.089/+0.127	88.900 +/-0.190			BP05080-06033-08890-BS	Bushes - Bronze - Sintered - Unflanged
50.800 +0.064/+0.102	60.325 +0.089/+0.127	101.600 +/-0.254			BP05080-06033-10160-BS	Bushes - Bronze - Sintered - Unflanged
50.800 x 63.500 mm (2.000 x 2.500 in.)						
50.800 +0.064/+0.102	63.500 +0.089/+0.127	25.400 +/-0.127			BP05080-06350-02540-BS	Bushes - Bronze - Sintered - Unflanged
50.800 +0.013/-0.000	63.500 +0.013/-0.000	31.750 +0.00/-1.52			BP05080-06350-03175-BAG	Bushes - Aluminium Bronze - Graphite Plug - Unflanged
50.800 +0.013/-0.000	63.500 +0.013/-0.000	34.925 +0.00/-1.52	68.07	4.76	BF05080-06350-03493-BA	Bushes - Aluminium Bronze - Flanged
50.800 +0.013/-0.000	63.500 +0.013/-0.000	34.925 +0.00/-1.52	68.07	4.76	BF05080-06350-03493-BAG	Bushes - Aluminium Bronze - Graphite Plug - Flanged
50.800 +0.064/+0.102	63.500 +0.089/+0.127	38.100 +/-0.127			BP05080-06350-03810-BS	Bushes - Bronze - Sintered - Unflanged
50.800 +0.013/-0.000	63.500 +0.013/-0.000	38.100 +0.00/-1.52			BP05080-06350-03810-BA	Bushes - Aluminium Bronze - Unflanged
50.800 +0.013/-0.000	63.500 +0.013/-0.000	38.100 +0.00/-1.52			BP05080-06350-03810-BAG	Bushes - Aluminium Bronze - Graphite Plug - Unflanged
50.800 +0.013/-0.000	63.500 +0.013/-0.000	47.625 +0.00/-1.52	68.07	4.76	BF05080-06350-04763-BA	Bushes - Aluminium Bronze - Flanged
50.800 +0.013/-0.000	63.500 +0.013/-0.000	47.625 +0.00/-1.52	68.07	4.76	BF05080-06350-04763-BAG	Bushes - Aluminium Bronze - Graphite Plug - Flanged
50.800 +0.064/+0.102	63.500 +0.089/+0.127	50.800 +/-0.190			BP05080-06350-05080-BS	Bushes - Bronze - Sintered - Unflanged
50.800 +0.013/-0.000	63.500 +0.013/-0.000	50.800 +0.00/-1.52			BP05080-06350-05080-BA	Bushes - Aluminium Bronze - Unflanged
50.800 +0.013/-0.000	63.500 +0.013/-0.000	50.800 +0.00/-1.52			BP05080-06350-05080-BAG	Bushes - Aluminium Bronze - Graphite Plug - Unflanged
50.800 +/-0.0254	63.500 +0.0508/+0.0762	50.800 +/-0.127			BP05080-06350-05080-BC9	Bushes - Bronze - Solid - Leaded Gunmetal
50.800 +0.013/-0.000	63.500 +0.013/-0.000	60.325 +0.00/-1.52	68.07	4.76	BF05080-06350-06033-BA	Bushes - Aluminium Bronze - Flanged
50.800 +0.013/-0.000	63.500 +0.013/-0.000	60.325 +0.00/-1.52	68.07	4.76	BF05080-06350-06033-BAG	Bushes - Aluminium Bronze - Graphite Plug - Flanged
50.800 +0.064/+0.102	63.500 +0.089/+0.127	63.500 +/-0.190			BP05080-06350-06350-BS	Bushes - Bronze - Sintered - Unflanged
50.800 +0.013/-0.000	63.500 +0.013/-0.000	63.500 +0.00/-1.52			BP05080-06350-06350-BAG	Bushes - Aluminium Bronze - Graphite Plug - Unflanged
50.800 +0.013/-0.000	63.500 +0.013/-0.000	63.500 +0.00/-1.52			BP05080-06350-06350-BA	Bushes - Aluminium Bronze - Unflanged
50.800 +/-0.0254	63.500 +0.0508/+0.0762	63.500 +/-0.127			BP05080-06350-06350-BLG	Bushes - Bronze - Solid - Leaded Gunmetal
50.800 +0.013/-0.000	63.500 +0.013/-0.000	73.025 +0.00/-1.52	68.07	4.76	BF05080-06350-07303-BAG	Bushes - Aluminium Bronze - Graphite Plug - Flanged
50.800 +0.013/-0.000	63.500 +0.013/-0.000	73.025 +0.00/-1.52	68.07	4.76	BF05080-06350-07303-BA	Bushes - Aluminium Bronze - Flanged
50.800 +0.013/-0.000	63.500 +0.013/-0.000	76.200 +0.00/-1.52			BP05080-06350-07620-BA	Bushes - Aluminium Bronze - Unflanged
50.800 +0.013/-0.000	63.500 +0.013/-0.000	76.200 +0.00/-1.52			BP05080-06350-07620-BAG	Bushes - Aluminium Bronze - Graphite Plug - Unflanged

 Stocked or Short Delivery

 Usually Available

 Long delivery or not in current production

ID	OD	B	DF	bf	Part Number	Type
50.800 x 63.500 mm (2.000 x 2.500 in.)						
50.800 +0.064/+0.102	63.500 +0.089/+0.127	76.200 +/-0.190			BP05080-06350-07620-BS	Bushes - Bronze - Sintered - Unflanged
50.800 +/-0.0254	63.500 +0.0508/+0.0762	76.200 +/-0.127			BP05080-06350-07620-BC9	Bushes - Bronze - Solid - Leaded Gunmetal
50.800 +/-0.0254	63.500 +0.0508/+0.0762	76.200 +/-0.127			BP05080-06350-07620-BLG	Bushes - Bronze - Solid - Leaded Gunmetal
50.800 +0.013/-0.000	63.500 +0.013/-0.000	85.725 +0.00/-1.52	68.07	4.76	BF05080-06350-08573-BAG	Bushes - Aluminium Bronze - Graphite Plug - Flanged
50.800 +0.013/-0.000	63.500 +0.013/-0.000	85.725 +0.00/-1.52	68.07	4.76	BF05080-06350-08573-BA	Bushes - Aluminium Bronze - Flanged
50.800 +0.064/+0.102	63.500 +0.089/+0.127	88.900 +/-0.190			BP05080-06350-08890-BS	Bushes - Bronze - Sintered - Unflanged
50.800 +/-0.0254	63.500 +0.0508/+0.0762	88.900 +/-0.127			BP05080-06350-08890-BLG	Bushes - Bronze - Solid - Leaded Gunmetal
50.800 +0.013/-0.000	63.500 +0.013/-0.000	98.425 +0.00/-1.52			BP05080-06350-09843-BA	Bushes - Aluminium Bronze - Unflanged
50.800 +0.013/-0.000	63.500 +0.013/-0.000	98.425 +0.00/-1.52			BP05080-06350-09843-BAG	Bushes - Aluminium Bronze - Graphite Plug - Unflanged
50.800 +0.013/-0.000	63.500 +0.013/-0.000	98.425 +0.00/-1.52	68.07	4.76	BF05080-06350-09843-BA	Bushes - Aluminium Bronze - Flanged
50.800 +0.013/-0.000	63.500 +0.013/-0.000	98.425 +0.00/-1.52	68.07	4.76	BF05080-06350-09843-BAG	Bushes - Aluminium Bronze - Graphite Plug - Flanged
50.800 +0.064/+0.102	63.500 +0.089/+0.127	101.600 +/-0.254			BP05080-06350-10160-BS	Bushes - Bronze - Sintered - Unflanged
50.800 +/-0.0254	63.500 +0.0508/+0.0762	101.600 +/-0.127			BP05080-06350-10160-BLG	Bushes - Bronze - Solid - Leaded Gunmetal
50.800 +0.013/-0.000	63.500 +0.013/-0.000	111.125 +0.00/-1.52	68.07	4.76	BF05080-06350-11113-BA	Bushes - Aluminium Bronze - Flanged
50.800 +0.013/-0.000	63.500 +0.013/-0.000	111.125 +0.00/-1.52	68.07	4.76	BF05080-06350-11113-BAG	Bushes - Aluminium Bronze - Graphite Plug - Flanged
50.800 +0.013/-0.000	63.500 +0.013/-0.000	123.825 +0.00/-1.52	68.07	4.76	BF05080-06350-12383-BA	Bushes - Aluminium Bronze - Flanged
50.800 +0.013/-0.000	63.500 +0.013/-0.000	123.825 +0.00/-1.52	68.07	4.76	BF05080-06350-12383-BAG	Bushes - Aluminium Bronze - Graphite Plug - Flanged
50.800 +0.013/-0.000	63.500 +0.013/-0.000	149.225 +0.00/-1.52	68.07	4.76	BF05080-06350-14923-BA	Bushes - Aluminium Bronze - Flanged
50.800 +0.013/-0.000	63.500 +0.013/-0.000	149.225 +0.00/-1.52	68.07	4.76	BF05080-06350-14923-BAG	Bushes - Aluminium Bronze - Graphite Plug - Flanged
53.975 x 58.674 mm (2.125 x 2.310 in.)						
53.975 -0.018/-0.028	58.674 +0.013/-0.018	76.200 +0.00/-0.40			BP05398-05867-07620-DP4	Bushes - Steel - DP4 - Split - Unflanged
53.975 -0.018/-0.028	58.674 +0.013/-0.018	76.200 +0.00/-0.40			BP05398-05867-07620-DU	Bushes - Steel - DU - Split - Unflanged
53.975 -0.018/-0.028	58.674 +0.013/-0.018	76.200 +0.25/-0.25			BP05398-05867-07620-SS6	Bushes - Stainless Steel and PTFE - Unflanged
55.000 x 60.000 mm (2.165 x 2.362 in.)						
55.000 -0.000/-0.030	60.000 +0.030/-0.000	20.000 +0.25/-0.25			BP05500-06000-02000-DP4	Bushes - Steel - DP4 - Split - Unflanged
55.000 -0.000/-0.060	60.000 +0.100/-0.000	20.000 +0.25/-0.25			BP05500-06000-02000-DU	Bushes - Steel - DU - Split - Unflanged
55.000 -0.000/-0.060	60.000 +0.100/-0.000	20.000 +0.25/-0.25			BP05500-06000-02000-DX	Bushes - Steel - DX - Split - Unflanged
55.000 -0.000/-0.030	60.000 +0.030/-0.000	25.000 +0.25/-0.25			BP05500-06000-02500-DP4	Bushes - Steel - DP4 - Split - Unflanged
55.000 -0.000/-0.060	60.000 +0.100/-0.000	25.000 +0.25/-0.25			BP05500-06000-02500-DU	Bushes - Steel - DU - Split - Unflanged
55.000 -0.000/-0.060	60.000 +0.100/-0.000	25.000 +0.25/-0.25			BP05500-06000-02500-DX	Bushes - Steel - DX - Split - Unflanged
55.000 -0.000/-0.030	60.000 +0.030/-0.000	30.000 +0.25/-0.25			BP05500-06000-03000-DP4	Bushes - Steel - DP4 - Split - Unflanged
55.000 -0.000/-0.060	60.000 +0.100/-0.000	30.000 +0.00/-0.40			BP05500-06000-03000-DU	Bushes - Steel - DU - Split - Unflanged
55.000 -0.000/-0.060	60.000 +0.100/-0.000	30.000 +0.00/-0.40			BP05500-06000-03000-SS6	Bushes - Stainless Steel and PTFE - Unflanged
55.000 -0.000/-0.060	60.000 +0.100/-0.000	30.000 +0.25/-0.25			BP05500-06000-03000-DX	Bushes - Steel - DX - Split - Unflanged
55.000 -0.000/-0.060	60.000 +0.100/-0.000	40.000 +0.00/-0.40			BP05500-06000-04000-SS6	Bushes - Stainless Steel and PTFE - Unflanged
55.000 -0.000/-0.030	60.000 +0.030/-0.000	40.000 +0.25/-0.25			BP05500-06000-04000-DP4	Bushes - Steel - DP4 - Split - Unflanged
55.000 -0.000/-0.060	60.000 +0.100/-0.000	40.000 +0.00/-0.40			BP05500-06000-04000-DU	Bushes - Steel - DU - Split - Unflanged
55.000 -0.000/-0.060	60.000 +0.100/-0.000	40.000 +0.25/-0.25			BP05500-06000-04000-DUB	Bushes - Steel - DUB - Split - Unflanged
55.000 -0.000/-0.060	60.000 +0.100/-0.000	40.000 +0.25/-0.25			BP05500-06000-04000-DX	Bushes - Steel - DX - Split - Unflanged
55.000 -0.000/-0.030	60.000 +0.030/-0.000	50.000 +0.25/-0.25			BP05500-06000-05000-DP4	Bushes - Steel - DP4 - Split - Unflanged

 Stocked or Short Delivery

 Usually Available

 Long delivery or not in current production

ID	OD	B	DF	bf	Part Number	Type
55.000 x 60.000 mm (2.165 x 2.362 in.)						
55.000 -0.000/-0.060	60.000 +0.100/-0.000	50.000 +0.00/-0.40			BP05500-06000-05000-DU	Bushes - Steel - DU - Split - Unflanged
55.000 -0.000/-0.060	60.000 +0.100/-0.000	50.000 +0.00/-0.40			BP05500-06000-05000-SS6	Bushes - Stainless Steel and PTFE - Unflanged
55.000 -0.000/-0.060	60.000 +0.100/-0.000	50.000 +0.25/-0.25			BP05500-06000-05000-DX	Bushes - Steel - DX - Split - Unflanged
55.000 -0.000/-0.030	60.000 +0.030/-0.000	55.000 +0.25/-0.25			BP05500-06000-05500-DP4	Bushes - Steel - DP4 - Split - Unflanged
55.000 -0.000/-0.060	60.000 +0.100/-0.000	55.000 +0.25/-0.25			BP05500-06000-05500-DU	Bushes - Steel - DU - Split - Unflanged
55.000 -0.000/-0.060	60.000 +0.100/-0.000	60.000 +0.00/-0.40			BP05500-06000-06000-SS6	Bushes - Stainless Steel and PTFE - Unflanged
55.000 -0.000/-0.030	60.000 +0.030/-0.000	60.000 +0.25/-0.25			BP05500-06000-06000-DP4	Bushes - Steel - DP4 - Split - Unflanged
55.000 -0.000/-0.060	60.000 +0.100/-0.000	60.000 +0.00/-0.40			BP05500-06000-06000-DU	Bushes - Steel - DU - Split - Unflanged
55.000 -0.000/-0.060	60.000 +0.100/-0.000	60.000 +0.25/-0.25			BP05500-06000-06000-DX	Bushes - Steel - DX - Split - Unflanged

57.150 x 61.918 mm (2.250 x 2.438 in.)						
57.150 -0.018/-0.028	61.918 +0.051/-0.025	44.450 +0.25/-0.25			BP05715-06192-04445-SS6	Bushes - Stainless Steel and PTFE - Unflanged
57.150 -0.018/-0.028	61.918 +0.051/-0.025	44.450 +0.00/-0.40			BP05715-06192-04445-DP4	Bushes - Steel - DP4 - Split - Unflanged
57.150 -0.018/-0.028	61.918 +0.051/-0.025	44.450 +0.00/-0.40			BP05715-06192-04445-DU	Bushes - Steel - DU - Split - Unflanged
57.150 -0.018/-0.028	61.918 +0.051/-0.025	50.800 +0.25/-0.25			BP05715-06192-05080-SS6	Bushes - Stainless Steel and PTFE - Unflanged
57.150 -0.018/-0.028	61.918 +0.051/-0.025	50.800 +0.00/-0.40			BP05715-06192-05080-DP4	Bushes - Steel - DP4 - Split - Unflanged
57.150 -0.018/-0.028	61.918 +0.051/-0.025	50.800 +0.00/-0.40			BP05715-06192-05080-DU	Bushes - Steel - DU - Split - Unflanged
57.150 -0.018/-0.028	61.918 +0.051/-0.025	63.500 +0.00/-0.40			BP05715-06192-06350-DP4	Bushes - Steel - DP4 - Split - Unflanged
57.150 -0.018/-0.028	61.918 +0.051/-0.025	63.500 +0.00/-0.40			BP05715-06192-06350-DU	Bushes - Steel - DU - Split - Unflanged
57.150 -0.018/-0.028	61.918 +0.051/-0.025	63.500 +0.25/-0.25			BP05715-06192-06350-SS6	Bushes - Stainless Steel and PTFE - Unflanged
57.150 -0.018/-0.028	61.918 +0.051/-0.025	76.200 +0.00/-0.40			BP05715-06192-07620-DP4	Bushes - Steel - DP4 - Split - Unflanged
57.150 -0.018/-0.028	61.918 +0.051/-0.025	76.200 +0.00/-0.40			BP05715-06192-07620-DU	Bushes - Steel - DU - Split - Unflanged
57.150 -0.018/-0.028	61.918 +0.051/-0.025	76.200 +0.25/-0.25			BP05715-06192-07620-SS6	Bushes - Stainless Steel and PTFE - Unflanged
57.150 -0.018/-0.028	61.918 +0.051/-0.025	88.900 +0.00/-0.40			BP05715-06192-08890-DP4	Bushes - Steel - DP4 - Split - Unflanged
57.150 -0.018/-0.028	61.918 +0.051/-0.025	88.900 +0.00/-0.40			BP05715-06192-08890-DU	Bushes - Steel - DU - Split - Unflanged
57.150 -0.018/-0.028	61.918 +0.051/-0.025	88.900 +0.25/-0.25			BP05715-06192-08890-SS6	Bushes - Stainless Steel and PTFE - Unflanged
57.150 -0.018/-0.028	61.918 +0.051/-0.025	95.250 +0.00/-0.40			BP05715-06192-09525-DP4	Bushes - Steel - DP4 - Split - Unflanged
57.150 -0.018/-0.028	61.918 +0.051/-0.025	95.250 +0.00/-0.40			BP05715-06192-09525-DU	Bushes - Steel - DU - Split - Unflanged
57.150 -0.018/-0.028	61.918 +0.051/-0.025	95.250 +0.25/-0.25			BP05715-06192-09525-SS6	Bushes - Stainless Steel and PTFE - Unflanged
57.150 -0.018/-0.028	61.918 +0.051/-0.025	101.600 +0.00/-0.40			BP05715-06192-10160-DP4	Bushes - Steel - DP4 - Split - Unflanged
57.150 -0.018/-0.028	61.918 +0.051/-0.025	101.600 +0.00/-0.40			BP05715-06192-10160-DU	Bushes - Steel - DU - Split - Unflanged
57.150 -0.018/-0.028	61.918 +0.051/-0.025	101.600 +0.25/-0.25			BP05715-06192-10160-SS6	Bushes - Stainless Steel and PTFE - Unflanged
57.150 -0.018/-0.028	61.918 +0.051/-0.025	114.300 +0.00/-0.40			BP05715-06192-11430-DP4	Bushes - Steel - DP4 - Split - Unflanged
57.150 -0.018/-0.028	61.918 +0.051/-0.025	114.300 +0.00/-0.40			BP05715-06192-11430-DU	Bushes - Steel - DU - Split - Unflanged
57.150 -0.018/-0.028	61.918 +0.051/-0.025	114.300 +0.25/-0.25			BP05715-06192-11430-SS6	Bushes - Stainless Steel and PTFE - Unflanged

57.150 x 66.675 mm (2.250 x 2.625 in.)						
57.150 +0.064/+0.102	66.675 +0.076/+0.127	50.800 +/-0.190			BP05715-06668-05080-BS	Bushes - Bronze - Sintered - Unflanged
57.150 +0.064/+0.102	66.675 +0.076/+0.127	63.500 +/-0.190			BP05715-06668-06350-BS	Bushes - Bronze - Sintered - Unflanged
57.150 +0.064/+0.102	66.675 +0.076/+0.127	76.200 +/-0.190			BP05715-06668-07620-BS	Bushes - Bronze - Sintered - Unflanged

57.150 x 69.850 mm (2.250 x 2.750 in.)						
57.150 +0.064/+0.102	69.850 +0.076/+0.127	50.800 +/-0.190			BP05715-06985-05080-BS	Bushes - Bronze - Sintered - Unflanged

 Stocked or Short Delivery

 Usually Available

 Long delivery or not in current production

ID	OD	B	DF	bf	Part Number	Type
----	----	---	----	----	-------------	------

57.150 x 69.850 mm (2.250 x 2.750 in.)						
57.150 +/-0.0254	69.850 +0.0508/+0.0762	63.500 +/-0.127			BP05715-06985-06350-BLG	Bushes - Bronze - Solid - Leaded Gunmetal
57.150 +0.064/+0.102	69.850 +0.076/+0.127	76.200 +/-0.190			BP05715-06985-07620-BS	Bushes - Bronze - Sintered - Unflanged
57.150 +/-0.0254	69.850 +0.0508/+0.0762	76.200 +/-0.127			BP05715-06985-07620-BLG	Bushes - Bronze - Solid - Leaded Gunmetal
57.150 +/-0.0254	69.850 +0.0508/+0.0762	88.900 +/-0.127			BP05715-06985-08890-BLG	Bushes - Bronze - Solid - Leaded Gunmetal
57.150 +/-0.0254	69.850 +0.0508/+0.0762	101.600 +/-0.127			BP05715-06985-10160-BLG	Bushes - Bronze - Solid - Leaded Gunmetal

60.000 x 65.000 mm (2.362 x 2.559 in.)						
60.000 -0.000/-0.030	65.000 +0.030/-0.000	20.000 +0.25/-0.25			BP06000-06500-02000-DP4	Bushes - Steel - DP4 - Split - Unflanged
60.000 -0.000/-0.060	65.000 +0.100/-0.000	20.000 +0.25/-0.25			BP06000-06500-02000-DU	Bushes - Steel - DU - Split - Unflanged
60.000 -0.000/-0.060	65.000 +0.100/-0.000	30.000 +0.00/-0.40			BP06000-06500-03000-SS6	Bushes - Stainless Steel and PTFE - Unflanged
60.000 -0.000/-0.030	65.000 +0.030/-0.000	30.000 +0.25/-0.25			BP06000-06500-03000-DP4	Bushes - Steel - DP4 - Split - Unflanged
60.000 -0.000/-0.060	65.000 +0.100/-0.000	30.000 +0.00/-0.40			BP06000-06500-03000-DU	Bushes - Steel - DU - Split - Unflanged
60.000 -0.000/-0.060	65.000 +0.100/-0.000	30.000 +0.25/-0.25			BP06000-06500-03000-DX	Bushes - Steel - DX - Split - Unflanged
60.000 -0.000/-0.030	65.000 +0.030/-0.000	40.000 +0.25/-0.25			BP06000-06500-04000-DP4	Bushes - Steel - DP4 - Split - Unflanged
60.000 -0.000/-0.060	65.000 +0.100/-0.000	40.000 +0.00/-0.40			BP06000-06500-04000-DU	Bushes - Steel - DU - Split - Unflanged
60.000 -0.000/-0.060	65.000 +0.100/-0.000	40.000 +0.00/-0.40			BP06000-06500-04000-SS6	Bushes - Stainless Steel and PTFE - Unflanged
60.000 -0.000/-0.060	65.000 +0.100/-0.000	40.000 +0.25/-0.25			BP06000-06500-04000-DUB	Bushes - Steel - DUB - Split - Unflanged
60.000 -0.000/-0.060	65.000 +0.100/-0.000	40.000 +0.25/-0.25			BP06000-06500-04000-DX	Bushes - Steel - DX - Split - Unflanged
60.000 -0.000/-0.030	65.000 +0.030/-0.000	50.000 +0.25/-0.25			BP06000-06500-05000-DP4	Bushes - Steel - DP4 - Split - Unflanged
60.000 -0.000/-0.060	65.000 +0.100/-0.000	50.000 +0.00/-0.40			BP06000-06500-05000-DU	Bushes - Steel - DU - Split - Unflanged
60.000 -0.000/-0.060	65.000 +0.100/-0.000	50.000 +0.00/-0.40			BP06000-06500-05000-SS6	Bushes - Stainless Steel and PTFE - Unflanged
60.000 -0.000/-0.060	65.000 +0.100/-0.000	50.000 +0.25/-0.25			BP06000-06500-05000-DUB	Bushes - Steel - DUB - Split - Unflanged
60.000 -0.000/-0.060	65.000 +0.100/-0.000	60.000 +0.00/-0.40			BP06000-06500-06000-DU	Bushes - Steel - DU - Split - Unflanged
60.000 -0.000/-0.030	65.000 +0.030/-0.000	60.000 +0.25/-0.25			BP06000-06500-06000-DP4	Bushes - Steel - DP4 - Split - Unflanged
60.000 -0.000/-0.060	65.000 +0.100/-0.000	60.000 +0.00/-0.40			BP06000-06500-06000-SS6	Bushes - Stainless Steel and PTFE - Unflanged
60.000 -0.000/-0.060	65.000 +0.100/-0.000	60.000 +0.25/-0.25			BP06000-06500-06000-DUB	Bushes - Steel - DUB - Split - Unflanged
60.000 -0.000/-0.060	65.000 +0.100/-0.000	60.000 +0.25/-0.25			BP06000-06500-06000-DX	Bushes - Steel - DX - Split - Unflanged
60.000 -0.000/-0.030	65.000 +0.030/-0.000	70.000 +0.25/-0.25			BP06000-06500-07000-DP4	Bushes - Steel - DP4 - Split - Unflanged
60.000 -0.000/-0.060	65.000 +0.100/-0.000	70.000 +0.00/-0.40			BP06000-06500-07000-DU	Bushes - Steel - DU - Split - Unflanged
60.000 -0.000/-0.060	65.000 +0.100/-0.000	70.000 +0.00/-0.40			BP06000-06500-07000-SS6	Bushes - Stainless Steel and PTFE - Unflanged
60.000 -0.000/-0.060	65.000 +0.100/-0.000	70.000 +0.25/-0.25			BP06000-06500-07000-DUB	Bushes - Steel - DUB - Split - Unflanged
60.000 -0.000/-0.060	65.000 +0.100/-0.000	70.000 +0.25/-0.25			BP06000-06500-07000-DX	Bushes - Steel - DX - Split - Unflanged

60.000 x 68.000 mm (2.362 x 2.677 in.)						
60.000 +0.010/+0.056	68.000 +0.059/+0.105	50.000 +/-0.190			BP06000-06800-05000-BSO	Bushes - Bronze - Sintered - Unflanged - Oilite
60.000 +0.010/+0.056	68.000 +0.059/+0.105	60.000 +/-0.250			BP06000-06800-06000-BSO	Bushes - Bronze - Sintered - Unflanged - Oilite

60.000 x 72.000 mm (2.362 x 2.835 in.)						
60.000 +0.010/+0.056	72.000 +0.059/+0.105	50.000 +/-0.190			BP06000-07200-05000-BSO	Bushes - Bronze - Sintered - Unflanged - Oilite
60.000 +0.010/+0.056	72.000 +0.059/+0.105	60.000 +/-0.250			BP06000-07200-06000-BSO	Bushes - Bronze - Sintered - Unflanged - Oilite
60.000 +0.010/+0.056	72.000 +0.059/+0.105	70.000 +/-0.250			BP06000-07200-07000-BSO	Bushes - Bronze - Sintered - Unflanged - Oilite

60.325 x 69.850 mm (2.375 x 2.750 in.)						
60.325 +0.064/+0.102	69.850 +0.076/+0.127	50.800 +/-0.190			BP06033-06985-05080-BS	Bushes - Bronze - Sintered - Unflanged

Stocked or Short Delivery

Usually Available

Long delivery or not in current production

ID	OD	B	DF	bf	Part Number	Type
60.325 x 69.850 mm (2.375 x 2.750 in.)						
60.325 +0.064/+0.102	69.850 +0.076/+0.127	63.500 +/-0.190			BP06033-06985-06350-BS	Bushes - Bronze - Sintered - Unflanged
60.325 +0.064/+0.102	69.850 +0.076/+0.127	76.200 +/-0.190			BP06033-06985-07620-BS	Bushes - Bronze - Sintered - Unflanged
63.500 x 68.275 mm (2.500 x 2.688 in.)						
63.500 -0.028/-0.018	68.275 +0.015/-0.015	25.400 +0.25/-0.25			BP06350-06828-02540-SS6	Bushes - Stainless Steel and PTFE - Unflanged
63.500 -0.028/-0.018	68.275 +0.015/-0.015	25.400 +0.00/-0.40			BP06350-06828-02540-DP4	Bushes - Steel - DP4 - Split - Unflanged
63.500 -0.028/-0.018	68.275 +0.015/-0.015	25.400 +0.00/-0.40			BP06350-06828-02540-DU	Bushes - Steel - DU - Split - Unflanged
63.500 -0.028/-0.018	68.275 +0.015/-0.015	41.275 +0.00/-0.40			BP06350-06828-04128-DP4	Bushes - Steel - DP4 - Split - Unflanged
63.500 -0.028/-0.018	68.275 +0.015/-0.015	41.275 +0.00/-0.40			BP06350-06828-04128-DU	Bushes - Steel - DU - Split - Unflanged
63.500 -0.028/-0.018	68.275 +0.015/-0.015	41.275 +0.25/-0.25			BP06350-06828-04128-SS6	Bushes - Stainless Steel and PTFE - Unflanged
63.500 -0.028/-0.018	68.275 +0.015/-0.015	50.800 +0.00/-0.40			BP06350-06828-05080-DP4	Bushes - Steel - DP4 - Split - Unflanged
63.500 -0.028/-0.018	68.275 +0.015/-0.015	50.800 +0.00/-0.40			BP06350-06828-05080-DU	Bushes - Steel - DU - Split - Unflanged
63.500 -0.028/-0.018	68.275 +0.015/-0.015	50.800 +0.25/-0.25			BP06350-06828-05080-SS6	Bushes - Stainless Steel and PTFE - Unflanged
63.500 -0.028/-0.018	68.275 +0.015/-0.015	63.500 +0.00/-0.40			BP06350-06828-06350-DP4	Bushes - Steel - DP4 - Split - Unflanged
63.500 -0.028/-0.018	68.275 +0.015/-0.015	63.500 +0.00/-0.40			BP06350-06828-06350-DU	Bushes - Steel - DU - Split - Unflanged
63.500 -0.028/-0.018	68.275 +0.015/-0.015	63.500 +0.25/-0.25			BP06350-06828-06350-SS6	Bushes - Stainless Steel and PTFE - Unflanged
63.500 -0.028/-0.018	68.275 +0.015/-0.015	76.200 +0.25/-0.25			BP06350-06828-07620-SS6	Bushes - Stainless Steel and PTFE - Unflanged
63.500 -0.028/-0.018	68.275 +0.015/-0.015	76.200 +0.00/-0.40			BP06350-06828-07620-DP4	Bushes - Steel - DP4 - Split - Unflanged
63.500 -0.028/-0.018	68.275 +0.015/-0.015	76.200 +0.00/-0.40			BP06350-06828-07620-DU	Bushes - Steel - DU - Split - Unflanged
63.500 -0.028/-0.018	68.275 +0.015/-0.015	88.900 +0.00/-0.40			BP06350-06828-08890-DP4	Bushes - Steel - DP4 - Split - Unflanged
63.500 -0.028/-0.018	68.275 +0.015/-0.015	88.900 +0.25/-0.25			BP06350-06828-08890-SS6	Bushes - Stainless Steel and PTFE - Unflanged
63.500 -0.028/-0.018	68.275 +0.015/-0.015	88.900 +0.00/-0.40			BP06350-06828-08890-DU	Bushes - Steel - DU - Split - Unflanged
63.500 -0.028/-0.018	68.275 +0.015/-0.015	95.250 +0.00/-0.40			BP06350-06828-09525-DP4	Bushes - Steel - DP4 - Split - Unflanged
63.500 -0.028/-0.018	68.275 +0.015/-0.015	95.250 +0.00/-0.40			BP06350-06828-09525-DU	Bushes - Steel - DU - Split - Unflanged
63.500 -0.028/-0.018	68.275 +0.015/-0.015	95.250 +0.25/-0.25			BP06350-06828-09525-SS6	Bushes - Stainless Steel and PTFE - Unflanged
63.500 -0.028/-0.018	68.275 +0.015/-0.015	101.600 +0.00/-0.40			BP06350-06828-10160-DP4	Bushes - Steel - DP4 - Split - Unflanged
63.500 -0.028/-0.018	68.275 +0.015/-0.015	101.600 +0.00/-0.40			BP06350-06828-10160-DU	Bushes - Steel - DU - Split - Unflanged
63.500 -0.028/-0.018	68.275 +0.015/-0.015	101.600 +0.25/-0.25			BP06350-06828-10160-SS6	Bushes - Stainless Steel and PTFE - Unflanged
63.500 -0.028/-0.018	68.275 +0.015/-0.015	114.300 +0.00/-0.40			BP06350-06828-11430-DP4	Bushes - Steel - DP4 - Split - Unflanged
63.500 -0.028/-0.018	68.275 +0.015/-0.015	114.300 +0.00/-0.40			BP06350-06828-11430-DU	Bushes - Steel - DU - Split - Unflanged
63.500 -0.028/-0.018	68.275 +0.015/-0.015	114.300 +0.25/-0.25			BP06350-06828-11430-SS6	Bushes - Stainless Steel and PTFE - Unflanged
63.500 x 69.850 mm (2.500 x 2.750 in.)						
63.500 +0.064/+0.102	69.850 +0.051/+0.102	50.800 +/-0.190			BP06350-06985-05080-BS	Bushes - Bronze - Sintered - Unflanged
63.500 +0.064/+0.102	69.850 +0.051/+0.102	63.500 +/-0.190			BP06350-06985-06350-BS	Bushes - Bronze - Sintered - Unflanged
63.500 +0.064/+0.102	69.850 +0.051/+0.102	76.200 +/-0.190			BP06350-06985-07620-BS	Bushes - Bronze - Sintered - Unflanged
63.500 +0.064/+0.102	69.850 +0.051/+0.102	101.600 +/-0.254			BP06350-06985-10160-BS	Bushes - Bronze - Sintered - Unflanged
63.500 x 73.025 mm (2.500 x 2.875 in.)						
63.500 +0.064/+0.102	73.025 +0.076/+0.127	57.150 +/-0.190			BP06350-07303-05715-BS	Bushes - Bronze - Sintered - Unflanged
63.500 +0.064/+0.102	73.025 +0.076/+0.127	63.500 +/-0.190			BP06350-07303-06350-BS	Bushes - Bronze - Sintered - Unflanged
63.500 +0.064/+0.102	73.025 +0.076/+0.127	76.200 +/-0.190			BP06350-07303-07620-BS	Bushes - Bronze - Sintered - Unflanged

 Stocked or Short Delivery

 Usually Available

 Long delivery or not in current production

ID	OD	B	DF	bf	Part Number	Type
63.500 x 76.200 mm (2.500 x 3.000 in.)						
63.500 +0.064/+0.102	76.200 +0.076/+0.127	50.800 +/-0.190			BP06350-07620-05080-BS	Bushes - Bronze - Sintered - Unflanged
63.500 +/-0.0254	76.200 +0.0508/+0.0762	63.500 +/-0.127			BP06350-07620-06350-BLG	Bushes - Bronze - Solid - Leaded Gunmetal
63.500 +0.064/+0.102	76.200 +0.076/+0.127	76.200 +/-0.190			BP06350-07620-07620-BS	Bushes - Bronze - Sintered - Unflanged
63.500 +/-0.0254	76.200 +0.0508/+0.0762	76.200 +/-0.127			BP06350-07620-07620-BLG	Bushes - Bronze - Solid - Leaded Gunmetal
63.500 +/-0.0254	76.200 +0.0508/+0.0762	88.900 +/-0.127			BP06350-07620-08890-BLG	Bushes - Bronze - Solid - Leaded Gunmetal
63.500 +0.064/+0.102	76.200 +0.076/+0.127	101.600 +/-0.254			BP06350-07620-10160-BS	Bushes - Bronze - Sintered - Unflanged
63.500 +/-0.0254	76.200 +0.0508/+0.0762	101.600 +/-0.127			BP06350-07620-10160-BLG	Bushes - Bronze - Solid - Leaded Gunmetal
63.500 +/-0.0254	76.200 +0.0508/+0.0762	127.000 +/-0.127			BP06350-07620-12700-BC9	Bushes - Bronze - Solid - Leaded Gunmetal
65.000 x 70.000 mm (2.559 x 2.756 in.)						
65.000 -0.000/-0.030	70.000 +0.030/-0.000	30.000 +0.25/-0.25			BP06500-07000-03000-DP4	Bushes - Steel - DP4 - Split - Unflanged
65.000 -0.000/-0.060	70.000 +0.100/-0.000	30.000 +0.00/-0.40			BP06500-07000-03000-DU	Bushes - Steel - DU - Split - Unflanged
65.000 -0.000/-0.060	70.000 +0.100/-0.000	30.000 +0.00/-0.40			BP06500-07000-03000-SS6	Bushes - Stainless Steel and PTFE - Unflanged
65.000 -0.000/-0.060	70.000 +0.100/-0.000	40.000 +0.00/-0.40			BP06500-07000-04000-SS6	Bushes - Stainless Steel and PTFE - Unflanged
65.000 -0.000/-0.060	70.000 +0.100/-0.000	40.000 +0.00/-0.40			BP06500-07000-04000-DP4	Bushes - Steel - DP4 - Split - Unflanged
65.000 -0.000/-0.060	70.000 +0.100/-0.000	40.000 +0.00/-0.40			BP06500-07000-04000-DU	Bushes - Steel - DU - Split - Unflanged
65.000 -0.000/-0.060	70.000 +0.100/-0.000	40.000 +0.25/-0.25			BP06500-07000-04000-DX	Bushes - Steel - DX - Split - Unflanged
65.000 -0.000/-0.030	70.000 +0.030/-0.000	50.000 +0.25/-0.25			BP06500-07000-05000-DP4	Bushes - Steel - DP4 - Split - Unflanged
65.000 -0.000/-0.060	70.000 +0.100/-0.000	50.000 +0.00/-0.40			BP06500-07000-05000-DU	Bushes - Steel - DU - Split - Unflanged
65.000 -0.000/-0.060	70.000 +0.100/-0.000	50.000 +0.00/-0.40			BP06500-07000-05000-SS6	Bushes - Stainless Steel and PTFE - Unflanged
65.000 -0.000/-0.060	70.000 +0.100/-0.000	50.000 +0.25/-0.25			BP06500-07000-05000-DX	Bushes - Steel - DX - Split - Unflanged
65.000 -0.000/-0.060	70.000 +0.100/-0.000	60.000 +0.00/-0.40			BP06500-07000-06000-DP4	Bushes - Steel - DP4 - Split - Unflanged
65.000 -0.000/-0.060	70.000 +0.100/-0.000	60.000 +0.00/-0.40			BP06500-07000-06000-DU	Bushes - Steel - DU - Split - Unflanged
65.000 -0.000/-0.060	70.000 +0.100/-0.000	60.000 +0.00/-0.40			BP06500-07000-06000-SS6	Bushes - Stainless Steel and PTFE - Unflanged
65.000 -0.000/-0.060	70.000 +0.100/-0.000	60.000 +0.25/-0.25			BP06500-07000-06000-DX	Bushes - Steel - DX - Split - Unflanged
65.000 -0.000/-0.060	70.000 +0.100/-0.000	70.000 +0.00/-0.40			BP06500-07000-07000-SS6	Bushes - Stainless Steel and PTFE - Unflanged
65.000 -0.000/-0.030	70.000 +0.030/-0.000	70.000 +0.25/-0.25			BP06500-07000-07000-DP4	Bushes - Steel - DP4 - Split - Unflanged
65.000 -0.000/-0.060	70.000 +0.100/-0.000	70.000 +0.00/-0.40			BP06500-07000-07000-DU	Bushes - Steel - DU - Split - Unflanged
65.000 -0.000/-0.060	70.000 +0.100/-0.000	70.000 +0.25/-0.25			BP06500-07000-07000-DUB	Bushes - Steel - DUB - Split - Unflanged
65.000 -0.000/-0.060	70.000 +0.100/-0.000	70.000 +0.25/-0.25			BP06500-07000-07000-DX	Bushes - Steel - DX - Split - Unflanged
69.850 x 74.600 mm (2.750 x 2.937 in.)						
69.850 -0.000/-0.046	74.600 +0.000/-0.043	50.800 +0.00/-0.40			BP06985-07460-05080-DU	Bushes - Steel - DU - Split - Unflanged
69.850 -0.000/-0.046	74.600 +0.000/-0.043	50.800 +0.25/-0.25			BP06985-07460-05080-SS6	Bushes - Stainless Steel and PTFE - Unflanged
69.850 -0.000/-0.046	74.600 +0.000/-0.043	50.800 +0.00/-0.40			BP06985-07460-05080-DP4	Bushes - Steel - DP4 - Split - Unflanged
69.850 -0.000/-0.046	74.600 +0.000/-0.043	57.150 +0.00/-0.40			BP06985-07460-05715-DP4	Bushes - Steel - DP4 - Split - Unflanged
69.850 -0.000/-0.046	74.600 +0.000/-0.043	57.150 +0.00/-0.40			BP06985-07460-05715-DU	Bushes - Steel - DU - Split - Unflanged
69.850 -0.000/-0.046	74.600 +0.000/-0.043	57.150 +0.25/-0.25			BP06985-07460-05715-SS6	Bushes - Stainless Steel and PTFE - Unflanged
69.850 -0.000/-0.046	74.600 +0.000/-0.043	63.500 +0.00/-0.40			BP06985-07460-06350-DP4	Bushes - Steel - DP4 - Split - Unflanged
69.850 -0.000/-0.046	74.600 +0.000/-0.043	63.500 +0.00/-0.40			BP06985-07460-06350-DU	Bushes - Steel - DU - Split - Unflanged
69.850 -0.000/-0.046	74.600 +0.000/-0.043	63.500 +0.25/-0.25			BP06985-07460-06350-SS6	Bushes - Stainless Steel and PTFE - Unflanged
69.850 -0.000/-0.046	74.600 +0.000/-0.043	76.200 +0.00/-0.40			BP06985-07460-07620-DP4	Bushes - Steel - DP4 - Split - Unflanged

 Stocked or Short Delivery

 Usually Available

 Long delivery or not in current production

ID	OD	B	DF	bf	Part Number	Type
69.850 x 74.600 mm (2.750 x 2.937 in.)						
69.850 -0.000/-0.046	74.600 +0.000/-0.043	76.200 +0.00/-0.40			BP06985-07460-07620-DU	Bushes - Steel - DU - Split - Unflanged
69.850 -0.000/-0.046	74.600 +0.000/-0.043	76.200 +0.25/-0.25			BP06985-07460-07620-SS6	Bushes - Stainless Steel and PTFE - Unflanged
69.850 -0.000/-0.046	74.600 +0.000/-0.043	88.900 +0.25/-0.25			BP06985-07460-08890-SS6	Bushes - Stainless Steel and PTFE - Unflanged
69.850 -0.000/-0.046	74.600 +0.000/-0.043	88.900 +0.00/-0.40			BP06985-07460-08890-DU	Bushes - Steel - DU - Split - Unflanged
69.850 -0.000/-0.046	74.600 +0.000/-0.043	88.900 +0.00/-0.40			BP06985-07460-08890-DP4	Bushes - Steel - DP4 - Split - Unflanged
69.850 -0.000/-0.046	74.600 +0.000/-0.043	95.250 +0.00/-0.40			BP06985-07460-09525-DU	Bushes - Steel - DU - Split - Unflanged
69.850 -0.000/-0.046	74.600 +0.000/-0.043	95.250 +0.25/-0.25			BP06985-07460-09525-SS6	Bushes - Stainless Steel and PTFE - Unflanged
69.850 -0.000/-0.046	74.600 +0.000/-0.043	95.250 +0.00/-0.40			BP06985-07460-09525-DP4	Bushes - Steel - DP4 - Split - Unflanged
69.850 -0.000/-0.046	74.600 +0.000/-0.043	101.600 +0.00/-0.40			BP06985-07460-10160-DP4	Bushes - Steel - DP4 - Split - Unflanged
69.850 -0.000/-0.046	74.600 +0.000/-0.043	101.600 +0.00/-0.40			BP06985-07460-10160-DU	Bushes - Steel - DU - Split - Unflanged
69.850 -0.000/-0.046	74.600 +0.000/-0.043	101.600 +0.25/-0.25			BP06985-07460-10160-SS6	Bushes - Stainless Steel and PTFE - Unflanged
69.850 -0.000/-0.046	74.600 +0.000/-0.043	114.300 +0.00/-0.40			BP06985-07460-11430-DP4	Bushes - Steel - DP4 - Split - Unflanged
69.850 -0.000/-0.046	74.600 +0.000/-0.043	114.300 +0.00/-0.40			BP06985-07460-11430-DU	Bushes - Steel - DU - Split - Unflanged
69.850 -0.000/-0.046	74.600 +0.000/-0.043	114.300 +0.25/-0.25			BP06985-07460-11430-SS6	Bushes - Stainless Steel and PTFE - Unflanged
69.850 -0.000/-0.046	74.600 +0.000/-0.043	120.650 +0.00/-0.40			BP06985-07460-12065-DP4	Bushes - Steel - DP4 - Split - Unflanged
69.850 -0.000/-0.046	74.600 +0.000/-0.043	120.650 +0.00/-0.40			BP06985-07460-12065-DU	Bushes - Steel - DU - Split - Unflanged
69.850 -0.000/-0.046	74.600 +0.000/-0.043	120.650 +0.25/-0.25			BP06985-07460-12065-SS6	Bushes - Stainless Steel and PTFE - Unflanged

69.850 x 76.200 mm (2.750 x 3.000 in.)						
69.850 +0.051/+0.102	76.200 +0.076/+0.127	38.100 +/-0.127			BP06985-07620-03810-BS	Bushes - Bronze - Sintered - Unflanged
69.850 +0.051/+0.102	76.200 +0.076/+0.127	63.500 +/-0.190			BP06985-07620-06350-BS	Bushes - Bronze - Sintered - Unflanged

69.850 x 82.550 mm (2.750 x 3.250 in.)						
69.850 +0.051/+0.102	82.550 +0.076/+0.127	50.800 +/-0.190			BP06985-08255-05080-BS	Bushes - Bronze - Sintered - Unflanged
69.850 +0.051/+0.102	82.550 +0.076/+0.127	76.200 +/-0.190			BP06985-08255-07620-BS	Bushes - Bronze - Sintered - Unflanged
69.850 +0.051/+0.102	82.550 +0.076/+0.127	101.600 +/-0.254			BP06985-08255-10160-BS	Bushes - Bronze - Sintered - Unflanged

70.000 x 75.000 mm (2.756 x 2.953 in.)						
70.000 -0.000/-0.030	75.000 +0.030/-0.000	40.000 +0.25/-0.25			BP07000-07500-04000-DP4	Bushes - Steel - DP4 - Split - Unflanged
70.000 -0.000/-0.060	75.000 +0.100/-0.000	40.000 +0.00/-0.40			BP07000-07500-04000-DU	Bushes - Steel - DU - Split - Unflanged
70.000 -0.000/-0.060	75.000 +0.100/-0.000	40.000 +0.00/-0.40			BP07000-07500-04000-SS6	Bushes - Stainless Steel and PTFE - Unflanged
70.000 -0.000/-0.060	75.000 +0.100/-0.000	40.000 +0.25/-0.25			BP07000-07500-04000-DX	Bushes - Steel - DX - Split - Unflanged
70.000 -0.000/-0.060	75.000 +0.100/-0.000	50.000 +0.00/-0.40			BP07000-07500-05000-DU	Bushes - Steel - DU - Split - Unflanged
70.000 -0.000/-0.060	75.000 +0.100/-0.000	50.000 +0.00/-0.40			BP07000-07500-05000-SS6	Bushes - Stainless Steel and PTFE - Unflanged
70.000 -0.000/-0.030	75.000 +0.030/-0.000	50.000 +0.25/-0.25			BP07000-07500-05000-DP4	Bushes - Steel - DP4 - Split - Unflanged
70.000 -0.000/-0.060	75.000 +0.100/-0.000	50.000 +0.25/-0.25			BP07000-07500-05000-DUB	Bushes - Steel - DUB - Split - Unflanged
70.000 -0.000/-0.060	75.000 +0.100/-0.000	50.000 +0.25/-0.25			BP07000-07500-05000-DX	Bushes - Steel - DX - Split - Unflanged
70.000 -0.000/-0.060	75.000 +0.100/-0.000	60.000 +0.00/-0.40			BP07000-07500-06000-DP4	Bushes - Steel - DP4 - Split - Unflanged
70.000 -0.000/-0.060	75.000 +0.100/-0.000	60.000 +0.00/-0.40			BP07000-07500-06000-DU	Bushes - Steel - DU - Split - Unflanged
70.000 -0.000/-0.060	75.000 +0.100/-0.000	60.000 +0.00/-0.40			BP07000-07500-06000-SS6	Bushes - Stainless Steel and PTFE - Unflanged
70.000 -0.000/-0.060	75.000 +0.100/-0.000	65.000 +0.25/-0.25			BP07000-07500-06500-DX	Bushes - Steel - DX - Split - Unflanged
70.000 -0.000/-0.060	75.000 +0.100/-0.000	70.000 +0.00/-0.40			BP07000-07500-07000-SS6	Bushes - Stainless Steel and PTFE - Unflanged
70.000 -0.000/-0.060	75.000 +0.100/-0.000	70.000 +0.00/-0.40			BP07000-07500-07000-DU	Bushes - Steel - DU - Split - Unflanged

 Stocked or Short Delivery

 Usually Available

 Long delivery or not in current production

ID	OD	B	DF	bf	Part Number	Type
70.000 x 75.000 mm (2.756 x 2.953 in.)						
70.000 -0.000/-0.030	75.000 +0.030/-0.000	70.000 +0.25/-0.25			BP07000-07500-07000-DP4	Bushes - Steel - DP4 - Split - Unflanged
70.000 -0.000/-0.060	75.000 +0.100/-0.000	70.000 +0.25/-0.25			BP07000-07500-07000-DUB	Bushes - Steel - DUB - Split - Unflanged
70.000 -0.000/-0.060	75.000 +0.100/-0.000	70.000 +0.25/-0.25			BP07000-07500-07000-DX	Bushes - Steel - DX - Split - Unflanged
70.000 -0.000/-0.060	75.000 +0.100/-0.000	80.000 +0.00/-0.40			BP07000-07500-08000-DP4	Bushes - Steel - DP4 - Split - Unflanged
70.000 -0.000/-0.060	75.000 +0.100/-0.000	80.000 +0.00/-0.40			BP07000-07500-08000-DU	Bushes - Steel - DU - Split - Unflanged
70.000 -0.000/-0.060	75.000 +0.100/-0.000	80.000 +0.00/-0.40			BP07000-07500-08000-SS6	Bushes - Stainless Steel and PTFE - Unflanged
70.000 -0.000/-0.060	75.000 +0.100/-0.000	80.000 +0.25/-0.25			BP07000-07500-08000-DX	Bushes - Steel - DX - Split - Unflanged

73.025 x 77.782 mm (2.875 x 3.062 in.)						
73.025 -0.005/-0.041	77.782 +0.000/-0.038	50.800 +0.00/-0.40			BP07303-07778-05080-DP4	Bushes - Steel - DP4 - Split - Unflanged
73.025 -0.005/-0.041	77.782 +0.000/-0.038	50.800 +0.00/-0.40			BP07303-07778-05080-DU	Bushes - Steel - DU - Split - Unflanged
73.025 -0.005/-0.041	77.782 +0.000/-0.038	50.800 +0.25/-0.25			BP07303-07778-05080-SS6	Bushes - Stainless Steel and PTFE - Unflanged
73.025 -0.005/-0.041	77.782 +0.000/-0.038	57.150 +0.00/-0.40			BP07303-07778-05715-DP4	Bushes - Steel - DP4 - Split - Unflanged
73.025 -0.005/-0.041	77.782 +0.000/-0.038	57.150 +0.00/-0.40			BP07303-07778-05715-DU	Bushes - Steel - DU - Split - Unflanged
73.025 -0.005/-0.041	77.782 +0.000/-0.038	57.150 +0.25/-0.25			BP07303-07778-05715-SS6	Bushes - Stainless Steel and PTFE - Unflanged
73.025 -0.005/-0.041	77.782 +0.000/-0.038	63.500 +0.00/-0.40			BP07303-07778-06350-DP4	Bushes - Steel - DP4 - Split - Unflanged
73.025 -0.005/-0.041	77.782 +0.000/-0.038	63.500 +0.00/-0.40			BP07303-07778-06350-DU	Bushes - Steel - DU - Split - Unflanged
73.025 -0.005/-0.041	77.782 +0.000/-0.038	63.500 +0.25/-0.25			BP07303-07778-06350-SS6	Bushes - Stainless Steel and PTFE - Unflanged
73.025 -0.005/-0.041	77.782 +0.000/-0.038	76.200 +0.00/-0.40			BP07303-07778-07620-DP4	Bushes - Steel - DP4 - Split - Unflanged
73.025 -0.005/-0.041	77.782 +0.000/-0.038	76.200 +0.00/-0.40			BP07303-07778-07620-DU	Bushes - Steel - DU - Split - Unflanged
73.025 -0.005/-0.041	77.782 +0.000/-0.038	76.200 +0.25/-0.25			BP07303-07778-07620-SS6	Bushes - Stainless Steel and PTFE - Unflanged
73.025 -0.005/-0.041	77.782 +0.000/-0.038	88.900 +0.00/-0.40			BP07303-07778-08890-DP4	Bushes - Steel - DP4 - Split - Unflanged
73.025 -0.005/-0.041	77.782 +0.000/-0.038	88.900 +0.00/-0.40			BP07303-07778-08890-DU	Bushes - Steel - DU - Split - Unflanged
73.025 -0.005/-0.041	77.782 +0.000/-0.038	88.900 +0.25/-0.25			BP07303-07778-08890-SS6	Bushes - Stainless Steel and PTFE - Unflanged
73.025 -0.005/-0.041	77.782 +0.000/-0.038	95.250 +0.00/-0.40			BP07303-07778-09525-DP4	Bushes - Steel - DP4 - Split - Unflanged
73.025 -0.005/-0.041	77.782 +0.000/-0.038	95.250 +0.00/-0.40			BP07303-07778-09525-DU	Bushes - Steel - DU - Split - Unflanged
73.025 -0.005/-0.041	77.782 +0.000/-0.038	95.250 +0.25/-0.25			BP07303-07778-09525-SS6	Bushes - Stainless Steel and PTFE - Unflanged
73.025 -0.005/-0.041	77.782 +0.000/-0.038	101.600 +0.00/-0.40			BP07303-07778-10160-DP4	Bushes - Steel - DP4 - Split - Unflanged
73.025 -0.005/-0.041	77.782 +0.000/-0.038	101.600 +0.00/-0.40			BP07303-07778-10160-DU	Bushes - Steel - DU - Split - Unflanged
73.025 -0.005/-0.041	77.782 +0.000/-0.038	101.600 +0.25/-0.25			BP07303-07778-10160-SS6	Bushes - Stainless Steel and PTFE - Unflanged
73.025 -0.005/-0.041	77.782 +0.000/-0.038	114.300 +0.00/-0.40			BP07303-07778-11430-DP4	Bushes - Steel - DP4 - Split - Unflanged
73.025 -0.005/-0.041	77.782 +0.000/-0.038	114.300 +0.00/-0.40			BP07303-07778-11430-DU	Bushes - Steel - DU - Split - Unflanged
73.025 -0.005/-0.041	77.782 +0.000/-0.038	114.300 +0.25/-0.25			BP07303-07778-11430-SS6	Bushes - Stainless Steel and PTFE - Unflanged
73.025 -0.005/-0.041	77.782 +0.000/-0.038	120.650 +0.00/-0.40			BP07303-07778-12065-DP4	Bushes - Steel - DP4 - Split - Unflanged
73.025 -0.005/-0.041	77.782 +0.000/-0.038	120.650 +0.00/-0.40			BP07303-07778-12065-DU	Bushes - Steel - DU - Split - Unflanged
73.025 -0.005/-0.041	77.782 +0.000/-0.038	120.650 +0.25/-0.25			BP07303-07778-12065-SS6	Bushes - Stainless Steel and PTFE - Unflanged

75.000 x 80.000 mm (2.953 x 3.150 in.)						
75.000 -0.000/-0.060	80.000 +0.100/-0.000	30.000 +0.00/-0.40			BP07500-08000-03000-SS6	Bushes - Stainless Steel and PTFE - Unflanged
75.000 -0.000/-0.060	80.000 +0.100/-0.000	30.000 +0.00/-0.40			BP07500-08000-03000-DP4	Bushes - Steel - DP4 - Split - Unflanged
75.000 -0.000/-0.060	80.000 +0.100/-0.000	30.000 +0.00/-0.40			BP07500-08000-03000-DU	Bushes - Steel - DU - Split - Unflanged
75.000 -0.000/-0.060	80.000 +0.100/-0.000	40.000 +0.00/-0.40			BP07500-08000-04000-SS6	Bushes - Stainless Steel and PTFE - Unflanged

 Stocked or Short Delivery

 Usually Available

 Long delivery or not in current production

ID	OD	B	DF	bf	Part Number	Type
75.000 x 80.000 mm (2.953 x 3.150 in.)						
75.000 -0.000/-0.060	80.000 +0.100/-0.000	40.000 +0.00/-0.40			BP07500-08000-04000-DP4	Bushes - Steel - DP4 - Split - Unflanged
75.000 -0.000/-0.060	80.000 +0.100/-0.000	40.000 +0.00/-0.40			BP07500-08000-04000-DU	Bushes - Steel - DU - Split - Unflanged
75.000 -0.000/-0.060	80.000 +0.100/-0.000	40.000 +0.25/-0.25			BP07500-08000-04000-DX	Bushes - Steel - DX - Split - Unflanged
75.000 -0.000/-0.060	80.000 +0.100/-0.000	50.000 +0.00/-0.40			BP07500-08000-05000-SS6	Bushes - Stainless Steel and PTFE - Unflanged
75.000 -0.000/-0.060	80.000 +0.100/-0.000	50.000 +0.00/-0.40			BP07500-08000-05000-DP4	Bushes - Steel - DP4 - Split - Unflanged
75.000 -0.000/-0.060	80.000 +0.100/-0.000	50.000 +0.00/-0.40			BP07500-08000-05000-DU	Bushes - Steel - DU - Split - Unflanged
75.000 -0.000/-0.060	80.000 +0.100/-0.000	60.000 +0.00/-0.40			BP07500-08000-06000-SS6	Bushes - Stainless Steel and PTFE - Unflanged
75.000 -0.000/-0.060	80.000 +0.100/-0.000	60.000 +0.00/-0.40			BP07500-08000-06000-DP4	Bushes - Steel - DP4 - Split - Unflanged
75.000 -0.000/-0.060	80.000 +0.100/-0.000	60.000 +0.00/-0.40			BP07500-08000-06000-DU	Bushes - Steel - DU - Split - Unflanged
75.000 -0.000/-0.060	80.000 +0.100/-0.000	60.000 +0.25/-0.25			BP07500-08000-06000-DX	Bushes - Steel - DX - Split - Unflanged
75.000 -0.000/-0.060	80.000 +0.100/-0.000	70.000 +0.00/-0.40			BP07500-08000-07000-DP4	Bushes - Steel - DP4 - Split - Unflanged
75.000 -0.000/-0.060	80.000 +0.100/-0.000	70.000 +0.00/-0.40			BP07500-08000-07000-DU	Bushes - Steel - DU - Split - Unflanged
75.000 -0.000/-0.060	80.000 +0.100/-0.000	70.000 +0.00/-0.40			BP07500-08000-07000-SS6	Bushes - Stainless Steel and PTFE - Unflanged
75.000 -0.000/-0.030	80.000 +0.030/-0.000	80.000 +0.25/-0.25			BP07500-08000-08000-DP4	Bushes - Steel - DP4 - Split - Unflanged
75.000 -0.000/-0.060	80.000 +0.100/-0.000	80.000 +0.00/-0.40			BP07500-08000-08000-DU	Bushes - Steel - DU - Split - Unflanged
75.000 -0.000/-0.060	80.000 +0.100/-0.000	80.000 +0.00/-0.40			BP07500-08000-08000-SS6	Bushes - Stainless Steel and PTFE - Unflanged
75.000 -0.000/-0.060	80.000 +0.100/-0.000	80.000 +0.25/-0.25			BP07500-08000-08000-DUB	Bushes - Steel - DUB - Split - Unflanged
75.000 -0.000/-0.060	80.000 +0.100/-0.000	80.000 +0.25/-0.25			BP07500-08000-08000-DX	Bushes - Steel - DX - Split - Unflanged

76.200 x 80.950 mm (3.000 x 3.187 in.)						
76.200 -0.000/-0.046	80.950 +0.000/-0.043	50.800 +0.00/-0.40			BP07620-08095-05080-DP4	Bushes - Steel - DP4 - Split - Unflanged
76.200 -0.000/-0.046	80.950 +0.000/-0.043	50.800 +0.00/-0.40			BP07620-08095-05080-DU	Bushes - Steel - DU - Split - Unflanged
76.200 -0.000/-0.046	80.950 +0.000/-0.043	50.800 +0.25/-0.25			BP07620-08095-05080-SS6	Bushes - Stainless Steel and PTFE - Unflanged
76.200 -0.000/-0.046	80.950 +0.000/-0.043	57.150 +0.00/-0.40			BP07620-08095-05715-DP4	Bushes - Steel - DP4 - Split - Unflanged
76.200 -0.000/-0.046	80.950 +0.000/-0.043	57.150 +0.25/-0.25			BP07620-08095-05715-SS6	Bushes - Stainless Steel and PTFE - Unflanged
76.200 -0.000/-0.046	80.950 +0.000/-0.043	57.150 +0.00/-0.40			BP07620-08095-05715-DU	Bushes - Steel - DU - Split - Unflanged
76.200 -0.000/-0.046	80.950 +0.000/-0.043	63.500 +0.00/-0.40			BP07620-08095-06350-DP4	Bushes - Steel - DP4 - Split - Unflanged
76.200 -0.000/-0.046	80.950 +0.000/-0.043	63.500 +0.00/-0.40			BP07620-08095-06350-DU	Bushes - Steel - DU - Split - Unflanged
76.200 -0.000/-0.046	80.950 +0.000/-0.043	63.500 +0.25/-0.25			BP07620-08095-06350-SS6	Bushes - Stainless Steel and PTFE - Unflanged
76.200 -0.000/-0.046	80.950 +0.000/-0.043	76.200 +0.25/-0.25			BP07620-08095-07620-SS6	Bushes - Stainless Steel and PTFE - Unflanged
76.200 -0.000/-0.046	80.950 +0.000/-0.043	76.200 +0.00/-0.40			BP07620-08095-07620-DP4	Bushes - Steel - DP4 - Split - Unflanged
76.200 -0.000/-0.046	80.950 +0.000/-0.043	76.200 +0.00/-0.40			BP07620-08095-07620-DU	Bushes - Steel - DU - Split - Unflanged
76.200 -0.000/-0.046	80.950 +0.000/-0.043	88.900 +0.25/-0.25			BP07620-08095-08890-SS6	Bushes - Stainless Steel and PTFE - Unflanged
76.200 -0.000/-0.046	80.950 +0.000/-0.043	88.900 +0.00/-0.40			BP07620-08095-08890-DP4	Bushes - Steel - DP4 - Split - Unflanged
76.200 -0.000/-0.046	80.950 +0.000/-0.043	88.900 +0.00/-0.40			BP07620-08095-08890-DU	Bushes - Steel - DU - Split - Unflanged
76.200 -0.000/-0.046	80.950 +0.000/-0.043	95.250 +0.00/-0.40			BP07620-08095-09525-DP4	Bushes - Steel - DP4 - Split - Unflanged
76.200 -0.000/-0.046	80.950 +0.000/-0.043	95.250 +0.00/-0.40			BP07620-08095-09525-DU	Bushes - Steel - DU - Split - Unflanged
76.200 -0.000/-0.046	80.950 +0.000/-0.043	95.250 +0.25/-0.25			BP07620-08095-09525-SS6	Bushes - Stainless Steel and PTFE - Unflanged
76.200 -0.000/-0.046	80.950 +0.000/-0.043	101.600 +0.00/-0.40			BP07620-08095-10160-DU	Bushes - Steel - DU - Split - Unflanged
76.200 -0.000/-0.046	80.950 +0.000/-0.043	101.600 +0.25/-0.25			BP07620-08095-10160-SS6	Bushes - Stainless Steel and PTFE - Unflanged
76.200 -0.000/-0.046	80.950 +0.000/-0.043	101.600 +0.00/-0.40			BP07620-08095-10160-DP4	Bushes - Steel - DP4 - Split - Unflanged
76.200 -0.000/-0.046	80.950 +0.000/-0.043	114.300 +0.00/-0.40			BP07620-08095-11430-DP4	Bushes - Steel - DP4 - Split - Unflanged

 Stocked or Short Delivery

 Usually Available

 Long delivery or not in current production

ID	OD	B	DF	bf	Part Number	Type
76.200 x 80.950 mm (3.000 x 3.187 in.)						
76.200 -0.000/-0.046	80.950 +0.000/-0.043	114.300 +0.00/-0.40			BP07620-08095-11430-DU	Bushes - Steel - DU - Split - Unflanged
76.200 -0.000/-0.046	80.950 +0.000/-0.043	114.300 +0.25/-0.25			BP07620-08095-11430-SS6	Bushes - Stainless Steel and PTFE - Unflanged
76.200 -0.000/-0.046	80.950 +0.000/-0.043	120.650 +0.00/-0.40			BP07620-08095-12065-DP4	Bushes - Steel - DP4 - Split - Unflanged
76.200 -0.000/-0.046	80.950 +0.000/-0.043	120.650 +0.00/-0.40			BP07620-08095-12065-DU	Bushes - Steel - DU - Split - Unflanged
76.200 -0.000/-0.046	80.950 +0.000/-0.043	120.650 +0.25/-0.25			BP07620-08095-12065-SS6	Bushes - Stainless Steel and PTFE - Unflanged
76.200 x 82.550 mm (3.000 x 3.250 in.)						
76.200 +0.051/+0.102	82.550 +0.076/+0.127	50.800 +/-0.190			BP07620-08255-05080-BS	Bushes - Bronze - Sintered - Unflanged
76.200 +0.051/+0.102	82.550 +0.076/+0.127	76.200 +/-0.190			BP07620-08255-07620-BS	Bushes - Bronze - Sintered - Unflanged
76.200 x 88.900 mm (3.000 x 3.500 in.)						
76.200 +0.051/+0.102	88.900 +0.076/+0.127	50.800 +/-0.190			BP07620-08890-05080-BS	Bushes - Bronze - Sintered - Unflanged
76.200 +0.025/+0.051	88.900 +0.051/+0	60.325 +/-0.190	101.60	9.53	BF07620-08890-06033-BS	Bushes - Bronze - Sintered - Flanged
76.200 +0.051/+0.102	88.900 +0.076/+0.127	63.500 +/-0.190			BP07620-08890-06350-BS	Bushes - Bronze - Sintered - Unflanged
76.200 +0.051/+0.102	88.900 +0.076/+0.127	76.200 +/-0.190			BP07620-08890-07620-BS	Bushes - Bronze - Sintered - Unflanged
76.200 +0.051/+0.102	88.900 +0.076/+0.127	101.600 +/-0.254			BP07620-08890-10160-BS	Bushes - Bronze - Sintered - Unflanged
76.200 +/-0.0254	88.900 +0.0762/+0.1270	101.600 +/-0.127			BP07620-08890-10160-BC9	Bushes - Bronze - Solid - Leaded Gunmetal
80.000 x 85.000 mm (3.150 x 3.346 in.)						
80.000 -0.000/-0.046	85.000 +0.120/-0.000	40.000 +0.50/-0.50			BP08000-08500-04000-DP4	Bushes - Steel - DP4 - Split - Unflanged
80.000 -0.000/-0.046	85.000 +0.120/-0.000	40.000 +0.00/-0.40			BP08000-08500-04000-SS6	Bushes - Stainless Steel and PTFE - Unflanged
80.000 -0.000/-0.046	85.000 +0.120/-0.000	40.000 +0.50/-0.50			BP08000-08500-04000-DU	Bushes - Steel - DU - Split - Unflanged
80.000 -0.000/-0.046	85.000 +0.120/-0.000	40.000 +0.50/-0.50			BP08000-08500-04000-DX	Bushes - Steel - DX - Split - Unflanged
80.000 -0.000/-0.046	85.000 +0.120/-0.000	50.000 +0.50/-0.50			BP08000-08500-05000-DP4	Bushes - Steel - DP4 - Split - Unflanged
80.000 -0.000/-0.046	85.000 +0.120/-0.000	50.000 +0.50/-0.50			BP08000-08500-05000-DU	Bushes - Steel - DU - Split - Unflanged
80.000 -0.000/-0.046	85.000 +0.120/-0.000	50.000 +0.00/-0.40			BP08000-08500-05000-SS6	Bushes - Stainless Steel and PTFE - Unflanged
80.000 -0.000/-0.046	85.000 +0.035/-0.000	60.000 +0.50/-0.50			BP08000-08500-06000-DP4	Bushes - Steel - DP4 - Split - Unflanged
80.000 -0.000/-0.046	85.000 +0.120/-0.000	60.000 +0.50/-0.50			BP08000-08500-06000-DU	Bushes - Steel - DU - Split - Unflanged
80.000 -0.000/-0.046	85.000 +0.120/-0.000	60.000 +0.00/-0.40			BP08000-08500-06000-SS6	Bushes - Stainless Steel and PTFE - Unflanged
80.000 -0.000/-0.046	85.000 +0.120/-0.000	60.000 +0.50/-0.50			BP08000-08500-06000-DUB	Bushes - Steel - DUB - Split - Unflanged
80.000 -0.000/-0.046	85.000 +0.120/-0.000	60.000 +0.50/-0.50			BP08000-08500-06000-DX	Bushes - Steel - DX - Split - Unflanged
80.000 -0.000/-0.046	85.000 +0.120/-0.000	70.000 +0.50/-0.50			BP08000-08500-07000-DP4	Bushes - Steel - DP4 - Split - Unflanged
80.000 -0.000/-0.046	85.000 +0.120/-0.000	70.000 +0.50/-0.50			BP08000-08500-07000-DU	Bushes - Steel - DU - Split - Unflanged
80.000 -0.000/-0.046	85.000 +0.120/-0.000	70.000 +0.00/-0.40			BP08000-08500-07000-SS6	Bushes - Stainless Steel and PTFE - Unflanged
80.000 -0.000/-0.046	85.000 +0.120/-0.000	80.000 +0.50/-0.50			BP08000-08500-08000-DU	Bushes - Steel - DU - Split - Unflanged
80.000 -0.000/-0.046	85.000 +0.120/-0.000	80.000 +0.00/-0.40			BP08000-08500-08000-SS6	Bushes - Stainless Steel and PTFE - Unflanged
80.000 -0.000/-0.046	85.000 +0.120/-0.000	80.000 +0.50/-0.50			BP08000-08500-08000-DP4	Bushes - Steel - DP4 - Split - Unflanged
80.000 -0.000/-0.046	85.000 +0.120/-0.000	80.000 +0.50/-0.50			BP08000-08500-08000-DX	Bushes - Steel - DX - Split - Unflanged
80.000 -0.000/-0.046	85.000 +0.035/-0.000	100.000 +0.50/-0.50			BP08000-08500-10000-DP4	Bushes - Steel - DP4 - Split - Unflanged
80.000 -0.000/-0.046	85.000 +0.120/-0.000	100.000 +0.50/-0.50			BP08000-08500-10000-DU	Bushes - Steel - DU - Split - Unflanged
80.000 -0.000/-0.046	85.000 +0.120/-0.000	100.000 +0.00/-0.40			BP08000-08500-10000-SS6	Bushes - Stainless Steel and PTFE - Unflanged
80.000 -0.000/-0.046	85.000 +0.120/-0.000	100.000 +0.50/-0.50			BP08000-08500-10000-DUB	Bushes - Steel - DUB - Split - Unflanged
80.000 -0.000/-0.046	85.000 +0.120/-0.000	100.000 +0.50/-0.50			BP08000-08500-10000-DX	Bushes - Steel - DX - Split - Unflanged

 Stocked or Short Delivery

 Usually Available

 Long delivery or not in current production

ID	OD	B	DF	bf	Part Number	Type
82.550 x 87.122 mm (3.250 x 3.430 in.)						
82.550 -0.025/-0.051	87.122 +0.000/-0.043	50.800 +0.50/-0.50			BP08255-08712-05080-DP4	Bushes - Steel - DP4 - Split - Unflanged
82.550 -0.025/-0.051	87.122 +0.000/-0.043	50.800 +0.50/-0.50			BP08255-08712-05080-DU	Bushes - Steel - DU - Split - Unflanged
82.550 -0.025/-0.051	87.122 +0.000/-0.043	50.800 +0.25/-0.25			BP08255-08712-05080-SS6	Bushes - Stainless Steel and PTFE - Unflanged
82.550 -0.025/-0.051	87.122 +0.000/-0.043	57.150 +0.50/-0.50			BP08255-08712-05715-DP4	Bushes - Steel - DP4 - Split - Unflanged
82.550 -0.025/-0.051	87.122 +0.000/-0.043	57.150 +0.50/-0.50			BP08255-08712-05715-DU	Bushes - Steel - DU - Split - Unflanged
82.550 -0.025/-0.051	87.122 +0.000/-0.043	57.150 +0.25/-0.25			BP08255-08712-05715-SS6	Bushes - Stainless Steel and PTFE - Unflanged
82.550 -0.025/-0.051	87.122 +0.000/-0.043	63.500 +0.50/-0.50			BP08255-08712-06350-DU	Bushes - Steel - DU - Split - Unflanged
82.550 -0.025/-0.051	87.122 +0.000/-0.043	63.500 +0.25/-0.25			BP08255-08712-06350-SS6	Bushes - Stainless Steel and PTFE - Unflanged
82.550 -0.025/-0.051	87.122 +0.000/-0.043	63.500 +0.50/-0.50			BP08255-08712-06350-DP4	Bushes - Steel - DP4 - Split - Unflanged
82.550 -0.025/-0.051	87.122 +0.000/-0.043	76.200 +0.50/-0.50			BP08255-08712-07620-DP4	Bushes - Steel - DP4 - Split - Unflanged
82.550 -0.025/-0.051	87.122 +0.000/-0.043	76.200 +0.50/-0.50			BP08255-08712-07620-DU	Bushes - Steel - DU - Split - Unflanged
82.550 -0.025/-0.051	87.122 +0.000/-0.043	76.200 +0.25/-0.25			BP08255-08712-07620-SS6	Bushes - Stainless Steel and PTFE - Unflanged
82.550 -0.025/-0.051	87.122 +0.000/-0.043	88.900 +0.50/-0.50			BP08255-08712-08890-DP4	Bushes - Steel - DP4 - Split - Unflanged
82.550 -0.025/-0.051	87.122 +0.000/-0.043	88.900 +0.50/-0.50			BP08255-08712-08890-DU	Bushes - Steel - DU - Split - Unflanged
82.550 -0.025/-0.051	87.122 +0.000/-0.043	88.900 +0.25/-0.25			BP08255-08712-08890-SS6	Bushes - Stainless Steel and PTFE - Unflanged
82.550 -0.025/-0.051	87.122 +0.000/-0.043	95.250 +0.50/-0.50			BP08255-08712-09525-DP4	Bushes - Steel - DP4 - Split - Unflanged
82.550 -0.025/-0.051	87.122 +0.000/-0.043	95.250 +0.50/-0.50			BP08255-08712-09525-DU	Bushes - Steel - DU - Split - Unflanged
82.550 -0.025/-0.051	87.122 +0.000/-0.043	95.250 +0.25/-0.25			BP08255-08712-09525-SS6	Bushes - Stainless Steel and PTFE - Unflanged
82.550 -0.025/-0.051	87.122 +0.000/-0.043	101.600 +0.50/-0.50			BP08255-08712-10160-DP4	Bushes - Steel - DP4 - Split - Unflanged
82.550 -0.025/-0.051	87.122 +0.000/-0.043	101.600 +0.50/-0.50			BP08255-08712-10160-DU	Bushes - Steel - DU - Split - Unflanged
82.550 -0.025/-0.051	87.122 +0.000/-0.043	101.600 +0.25/-0.25			BP08255-08712-10160-SS6	Bushes - Stainless Steel and PTFE - Unflanged
82.550 -0.025/-0.051	87.122 +0.000/-0.043	114.300 +0.50/-0.50			BP08255-08712-11430-DU	Bushes - Steel - DU - Split - Unflanged
82.550 -0.025/-0.051	87.122 +0.000/-0.043	114.300 +0.25/-0.25			BP08255-08712-11430-SS6	Bushes - Stainless Steel and PTFE - Unflanged
82.550 -0.025/-0.051	87.122 +0.000/-0.043	114.300 +0.50/-0.50			BP08255-08712-11430-DP4	Bushes - Steel - DP4 - Split - Unflanged
82.550 -0.025/-0.051	87.122 +0.000/-0.043	120.650 +0.50/-0.50			BP08255-08712-12065-DU	Bushes - Steel - DU - Split - Unflanged
82.550 -0.025/-0.051	87.122 +0.000/-0.043	120.650 +0.25/-0.25			BP08255-08712-12065-SS6	Bushes - Stainless Steel and PTFE - Unflanged
82.550 -0.025/-0.051	87.122 +0.000/-0.043	120.650 +0.50/-0.50			BP08255-08712-12065-DP4	Bushes - Steel - DP4 - Split - Unflanged

85.000 x 90.000 mm (3.346 x 3.543 in.)						
85.000 -0.000/-0.054	90.000 +0.035/-0.000	30.000 +0.50/-0.50			BP08500-09000-03000-DP4	Bushes - Steel - DP4 - Split - Unflanged
85.000 -0.000/-0.054	90.000 +0.120/-0.000	30.000 +0.50/-0.50			BP08500-09000-03000-DU	Bushes - Steel - DU - Split - Unflanged
85.000 -0.000/-0.054	90.000 +0.120/-0.000	30.000 +0.50/-0.50			BP08500-09000-03000-DX	Bushes - Steel - DX - Split - Unflanged
85.000 -0.000/-0.054	90.000 +0.120/-0.000	40.000 +0.50/-0.50			BP08500-09000-04000-DP4	Bushes - Steel - DP4 - Split - Unflanged
85.000 -0.000/-0.054	90.000 +0.120/-0.000	40.000 +0.00/-0.40			BP08500-09000-04000-SS6	Bushes - Stainless Steel and PTFE - Unflanged
85.000 -0.000/-0.054	90.000 +0.120/-0.000	40.000 +0.50/-0.50			BP08500-09000-04000-DU	Bushes - Steel - DU - Split - Unflanged
85.000 -0.000/-0.054	90.000 +0.120/-0.000	40.000 +0.50/-0.50			BP08500-09000-04000-DX	Bushes - Steel - DX - Split - Unflanged
85.000 -0.000/-0.054	90.000 +0.120/-0.000	60.000 +0.00/-0.40			BP08500-09000-06000-SS6	Bushes - Stainless Steel and PTFE - Unflanged
85.000 -0.000/-0.054	90.000 +0.035/-0.000	60.000 +0.50/-0.50			BP08500-09000-06000-DP4	Bushes - Steel - DP4 - Split - Unflanged
85.000 -0.000/-0.054	90.000 +0.120/-0.000	60.000 +0.50/-0.50			BP08500-09000-06000-DU	Bushes - Steel - DU - Split - Unflanged
85.000 -0.000/-0.054	90.000 +0.120/-0.000	60.000 +0.50/-0.50			BP08500-09000-06000-DX	Bushes - Steel - DX - Split - Unflanged
85.000 -0.000/-0.054	90.000 +0.120/-0.000	80.000 +0.00/-0.40			BP08500-09000-08000-SS6	Bushes - Stainless Steel and PTFE - Unflanged
85.000 -0.000/-0.054	90.000 +0.120/-0.000	80.000 +0.50/-0.50			BP08500-09000-08000-DU	Bushes - Steel - DU - Split - Unflanged

 Stocked or Short Delivery

 Usually Available

 Long delivery or not in current production

ID	OD	B	DF	bf	Part Number	Type
85.000 x 90.000 mm (3.346 x 3.543 in.)						
85.000 -0.000/-0.054	90.000 +0.120/-0.000	80.000 +0.50/-0.50			BP08500-09000-08000-DP4	Bushes - Steel - DP4 - Split - Unflanged
85.000 -0.000/-0.054	90.000 +0.120/-0.000	80.000 +0.50/-0.50			BP08500-09000-08000-DX	Bushes - Steel - DX - Split - Unflanged
85.000 -0.000/-0.054	90.000 +0.035/-0.000	100.000 +0.50/-0.50			BP08500-09000-10000-DP4	Bushes - Steel - DP4 - Split - Unflanged
85.000 -0.000/-0.054	90.000 +0.120/-0.000	100.000 +0.50/-0.50			BP08500-09000-10000-DU	Bushes - Steel - DU - Split - Unflanged
85.000 -0.000/-0.054	90.000 +0.120/-0.000	100.000 +0.50/-0.50			BP08500-09000-10000-SS6	Bushes - Stainless Steel and PTFE - Unflanged
85.000 -0.000/-0.054	90.000 +0.120/-0.000	100.000 +0.50/-0.50			BP08500-09000-10000-DUB	Bushes - Steel - DUB - Split - Unflanged
85.000 -0.000/-0.054	90.000 +0.120/-0.000	100.000 +0.50/-0.50			BP08500-09000-10000-DX	Bushes - Steel - DX - Split - Unflanged

88.900 x 93.650 mm (3.500 x 3.687 in.)						
88.900 -0.000/-0.056	93.650 +0.000/-0.043	50.800 +0.50/-0.50			BP08890-09365-05080-DP4	Bushes - Steel - DP4 - Split - Unflanged
88.900 -0.000/-0.056	93.650 +0.000/-0.043	50.800 +0.50/-0.50			BP08890-09365-05080-DU	Bushes - Steel - DU - Split - Unflanged
88.900 -0.000/-0.056	93.650 +0.000/-0.043	50.800 +0.25/-0.25			BP08890-09365-05080-SS6	Bushes - Stainless Steel and PTFE - Unflanged
88.900 -0.000/-0.056	93.650 +0.000/-0.043	57.150 +0.50/-0.50			BP08890-09365-05715-DP4	Bushes - Steel - DP4 - Split - Unflanged
88.900 -0.000/-0.056	93.650 +0.000/-0.043	57.150 +0.50/-0.50			BP08890-09365-05715-DU	Bushes - Steel - DU - Split - Unflanged
88.900 -0.000/-0.056	93.650 +0.000/-0.043	57.150 +0.25/-0.25			BP08890-09365-05715-SS6	Bushes - Stainless Steel and PTFE - Unflanged
88.900 -0.000/-0.056	93.650 +0.000/-0.043	63.500 +0.50/-0.50			BP08890-09365-06350-DP4	Bushes - Steel - DP4 - Split - Unflanged
88.900 -0.000/-0.056	93.650 +0.000/-0.043	63.500 +0.50/-0.50			BP08890-09365-06350-DU	Bushes - Steel - DU - Split - Unflanged
88.900 -0.000/-0.056	93.650 +0.000/-0.043	63.500 +0.25/-0.25			BP08890-09365-06350-SS6	Bushes - Stainless Steel and PTFE - Unflanged
88.900 -0.000/-0.056	93.650 +0.000/-0.043	76.200 +0.50/-0.50			BP08890-09365-07620-DP4	Bushes - Steel - DP4 - Split - Unflanged
88.900 -0.000/-0.056	93.650 +0.000/-0.043	76.200 +0.50/-0.50			BP08890-09365-07620-DU	Bushes - Steel - DU - Split - Unflanged
88.900 -0.000/-0.056	93.650 +0.000/-0.043	76.200 +0.25/-0.25			BP08890-09365-07620-SS6	Bushes - Stainless Steel and PTFE - Unflanged
88.900 -0.000/-0.056	93.650 +0.000/-0.043	88.900 +0.50/-0.50			BP08890-09365-08890-DP4	Bushes - Steel - DP4 - Split - Unflanged
88.900 -0.000/-0.056	93.650 +0.000/-0.043	88.900 +0.50/-0.50			BP08890-09365-08890-DU	Bushes - Steel - DU - Split - Unflanged
88.900 -0.000/-0.056	93.650 +0.000/-0.043	88.900 +0.25/-0.25			BP08890-09365-08890-SS6	Bushes - Stainless Steel and PTFE - Unflanged
88.900 -0.000/-0.056	93.650 +0.000/-0.043	95.250 +0.50/-0.50			BP08890-09365-09525-DP4	Bushes - Steel - DP4 - Split - Unflanged
88.900 -0.000/-0.056	93.650 +0.000/-0.043	95.250 +0.50/-0.50			BP08890-09365-09525-DU	Bushes - Steel - DU - Split - Unflanged
88.900 -0.000/-0.056	93.650 +0.000/-0.043	95.250 +0.25/-0.25			BP08890-09365-09525-SS6	Bushes - Stainless Steel and PTFE - Unflanged
88.900 -0.000/-0.056	93.650 +0.000/-0.043	101.600 +0.50/-0.50			BP08890-09365-10160-DP4	Bushes - Steel - DP4 - Split - Unflanged
88.900 -0.000/-0.056	93.650 +0.000/-0.043	101.600 +0.50/-0.50			BP08890-09365-10160-DU	Bushes - Steel - DU - Split - Unflanged
88.900 -0.000/-0.056	93.650 +0.000/-0.043	101.600 +0.25/-0.25			BP08890-09365-10160-SS6	Bushes - Stainless Steel and PTFE - Unflanged
88.900 -0.000/-0.056	93.650 +0.000/-0.043	114.300 +0.50/-0.50			BP08890-09365-11430-DP4	Bushes - Steel - DP4 - Split - Unflanged
88.900 -0.000/-0.056	93.650 +0.000/-0.043	114.300 +0.50/-0.50			BP08890-09365-11430-DU	Bushes - Steel - DU - Split - Unflanged
88.900 -0.000/-0.056	93.650 +0.000/-0.043	114.300 +0.25/-0.25			BP08890-09365-11430-SS6	Bushes - Stainless Steel and PTFE - Unflanged
88.900 -0.000/-0.056	93.650 +0.000/-0.043	120.650 +0.50/-0.50			BP08890-09365-12065-DP4	Bushes - Steel - DP4 - Split - Unflanged
88.900 -0.000/-0.056	93.650 +0.000/-0.043	120.650 +0.50/-0.50			BP08890-09365-12065-DU	Bushes - Steel - DU - Split - Unflanged
88.900 -0.000/-0.056	93.650 +0.000/-0.043	120.650 +0.25/-0.25			BP08890-09365-12065-SS6	Bushes - Stainless Steel and PTFE - Unflanged

88.900 x 101.600 mm (3.500 x 4.000 in.)						
88.900 +0.076/+0.102	101.600 +0.088/+0.152	76.200 +/-0.190			BP08890-10160-07620-BS	Bushes - Bronze - Sintered - Unflanged
88.900 +0.076/+0.102	101.600 +0.088/+0.152	88.900 +/-0.190			BP08890-10160-08890-BS	Bushes - Bronze - Sintered - Unflanged
88.900 +0.076/+0.102	101.600 +0.088/+0.152	101.600 +/-0.254			BP08890-10160-10160-BS	Bushes - Bronze - Sintered - Unflanged

 Stocked or Short Delivery

 Usually Available

 Long delivery or not in current production

ID	OD	B	DF	bf	Part Number	Type
90.000 x 95.000 mm (3.543 x 3.740 in.)						
90.000 -0.000/-0.054	95.000 +0.120/-0.000	40.000 +0.00/-0.40			BP09000-09500-04000-SS6	Bushes - Stainless Steel and PTFE - Unflanged
90.000 -0.000/-0.054	95.000 +0.120/-0.000	40.000 +0.50/-0.50			BP09000-09500-04000-DP4	Bushes - Steel - DP4 - Split - Unflanged
90.000 -0.000/-0.054	95.000 +0.120/-0.000	40.000 +0.50/-0.50			BP09000-09500-04000-DU	Bushes - Steel - DU - Split - Unflanged
90.000 -0.000/-0.054	95.000 +0.120/-0.000	40.000 +0.50/-0.50			BP09000-09500-04000-DX	Bushes - Steel - DX - Split - Unflanged
90.000 -0.000/-0.054	95.000 +0.120/-0.000	50.000 +0.00/-0.40			BP09000-09500-05000-SS6	Bushes - Stainless Steel and PTFE - Unflanged
90.000 -0.000/-0.054	95.000 +0.120/-0.000	50.000 +0.50/-0.50			BP09000-09500-05000-DP4	Bushes - Steel - DP4 - Split - Unflanged
90.000 -0.000/-0.054	95.000 +0.120/-0.000	50.000 +0.50/-0.50			BP09000-09500-05000-DU	Bushes - Steel - DU - Split - Unflanged
90.000 -0.000/-0.054	95.000 +0.120/-0.000	60.000 +0.00/-0.40			BP09000-09500-06000-SS6	Bushes - Stainless Steel and PTFE - Unflanged
90.000 -0.000/-0.054	95.000 +0.120/-0.000	60.000 +0.50/-0.50			BP09000-09500-06000-DP4	Bushes - Steel - DP4 - Split - Unflanged
90.000 -0.000/-0.054	95.000 +0.120/-0.000	60.000 +0.50/-0.50			BP09000-09500-06000-DU	Bushes - Steel - DU - Split - Unflanged
90.000 -0.000/-0.054	95.000 +0.120/-0.000	60.000 +0.50/-0.50			BP09000-09500-06000-DUB	Bushes - Steel - DUB - Split - Unflanged
90.000 -0.000/-0.054	95.000 +0.120/-0.000	60.000 +0.50/-0.50			BP09000-09500-06000-DX	Bushes - Steel - DX - Split - Unflanged
90.000 -0.000/-0.054	95.000 +0.120/-0.000	80.000 +0.50/-0.50			BP09000-09500-08000-DP4	Bushes - Steel - DP4 - Split - Unflanged
90.000 -0.000/-0.054	95.000 +0.120/-0.000	80.000 +0.50/-0.50			BP09000-09500-08000-DU	Bushes - Steel - DU - Split - Unflanged
90.000 -0.000/-0.054	95.000 +0.120/-0.000	80.000 +0.00/-0.40			BP09000-09500-08000-SS6	Bushes - Stainless Steel and PTFE - Unflanged
90.000 -0.000/-0.054	95.000 +0.120/-0.000	80.000 +0.50/-0.50			BP09000-09500-08000-DX	Bushes - Steel - DX - Split - Unflanged
90.000 -0.000/-0.054	95.000 +0.120/-0.000	90.000 +0.50/-0.50			BP09000-09500-09000-DX	Bushes - Steel - DX - Split - Unflanged
90.000 -0.000/-0.054	95.000 +0.035/-0.000	100.000 +0.50/-0.50			BP09000-09500-10000-DP4	Bushes - Steel - DP4 - Split - Unflanged
90.000 -0.000/-0.054	95.000 +0.120/-0.000	100.000 +0.50/-0.50			BP09000-09500-10000-DU	Bushes - Steel - DU - Split - Unflanged
90.000 -0.000/-0.054	95.000 +0.120/-0.000	100.000 +0.00/-0.40			BP09000-09500-10000-SS6	Bushes - Stainless Steel and PTFE - Unflanged
90.000 -0.000/-0.054	95.000 +0.120/-0.000	100.000 +0.50/-0.50			BP09000-09500-10000-DUB	Bushes - Steel - DUB - Split - Unflanged
90.000 -0.000/-0.054	95.000 +0.120/-0.000	100.000 +0.50/-0.50			BP09000-09500-10000-DX	Bushes - Steel - DX - Split - Unflanged

92.075 x 96.830 mm (3.625 x 3.812 in.)						
92.075 -0.000/-0.056	96.830 +0.000/-0.043	50.800 +0.50/-0.50			BP09208-09683-05080-DP4	Bushes - Steel - DP4 - Split - Unflanged
92.075 -0.000/-0.056	96.830 +0.000/-0.043	50.800 +0.25/-0.25			BP09208-09683-05080-SS6	Bushes - Stainless Steel and PTFE - Unflanged
92.075 -0.000/-0.056	96.830 +0.000/-0.043	50.800 +0.50/-0.50			BP09208-09683-05080-DU	Bushes - Steel - DU - Split - Unflanged
92.075 -0.000/-0.056	96.830 +0.000/-0.043	57.150 +0.50/-0.50			BP09208-09683-05715-DP4	Bushes - Steel - DP4 - Split - Unflanged
92.075 -0.000/-0.056	96.830 +0.000/-0.043	57.150 +0.50/-0.50			BP09208-09683-05715-DU	Bushes - Steel - DU - Split - Unflanged
92.075 -0.000/-0.056	96.830 +0.000/-0.043	57.150 +0.25/-0.25			BP09208-09683-05715-SS6	Bushes - Stainless Steel and PTFE - Unflanged
92.075 -0.000/-0.056	96.830 +0.000/-0.043	63.500 +0.50/-0.50			BP09208-09683-06350-DP4	Bushes - Steel - DP4 - Split - Unflanged
92.075 -0.000/-0.056	96.830 +0.000/-0.043	63.500 +0.50/-0.50			BP09208-09683-06350-DU	Bushes - Steel - DU - Split - Unflanged
92.075 -0.000/-0.056	96.830 +0.000/-0.043	63.500 +0.25/-0.25			BP09208-09683-06350-SS6	Bushes - Stainless Steel and PTFE - Unflanged
92.075 -0.000/-0.056	96.830 +0.000/-0.043	76.200 +0.50/-0.50			BP09208-09683-07620-DP4	Bushes - Steel - DP4 - Split - Unflanged
92.075 -0.000/-0.056	96.830 +0.000/-0.043	76.200 +0.50/-0.50			BP09208-09683-07620-DU	Bushes - Steel - DU - Split - Unflanged
92.075 -0.000/-0.056	96.830 +0.000/-0.043	76.200 +0.25/-0.25			BP09208-09683-07620-SS6	Bushes - Stainless Steel and PTFE - Unflanged
92.075 -0.000/-0.056	96.830 +0.000/-0.043	88.900 +0.50/-0.50			BP09208-09683-08890-DP4	Bushes - Steel - DP4 - Split - Unflanged
92.075 -0.000/-0.056	96.830 +0.000/-0.043	88.900 +0.50/-0.50			BP09208-09683-08890-DU	Bushes - Steel - DU - Split - Unflanged
92.075 -0.000/-0.056	96.830 +0.000/-0.043	88.900 +0.25/-0.25			BP09208-09683-08890-SS6	Bushes - Stainless Steel and PTFE - Unflanged
92.075 -0.000/-0.056	96.830 +0.000/-0.043	95.250 +0.50/-0.50			BP09208-09683-09525-DP4	Bushes - Steel - DP4 - Split - Unflanged
92.075 -0.000/-0.056	96.830 +0.000/-0.043	95.250 +0.50/-0.50			BP09208-09683-09525-DU	Bushes - Steel - DU - Split - Unflanged
92.075 -0.000/-0.056	96.830 +0.000/-0.043	95.250 +0.25/-0.25			BP09208-09683-09525-SS6	Bushes - Stainless Steel and PTFE - Unflanged

 Stocked or Short Delivery

 Usually Available

 Long delivery or not in current production

ID	OD	B	DF	bf	Part Number	Type
92.075 x 96.830 mm (3.625 x 3.812 in.)						
92.075 -0.000/-0.056	96.830 +0.000/-0.043	101.600 +0.50/-0.50			BP09208-09683-10160-DP4	Bushes - Steel - DP4 - Split - Unflanged
92.075 -0.000/-0.056	96.830 +0.000/-0.043	101.600 +0.50/-0.50			BP09208-09683-10160-DU	Bushes - Steel - DU - Split - Unflanged
92.075 -0.000/-0.056	96.830 +0.000/-0.043	101.600 +0.25/-0.25			BP09208-09683-10160-SS6	Bushes - Stainless Steel and PTFE - Unflanged
92.075 -0.000/-0.056	96.830 +0.000/-0.043	114.300 +0.25/-0.25			BP09208-09683-11430-SS6	Bushes - Stainless Steel and PTFE - Unflanged
92.075 -0.000/-0.056	96.830 +0.000/-0.043	114.300 +0.50/-0.50			BP09208-09683-11430-DP4	Bushes - Steel - DP4 - Split - Unflanged
92.075 -0.000/-0.056	96.830 +0.000/-0.043	114.300 +0.50/-0.50			BP09208-09683-11430-DU	Bushes - Steel - DU - Split - Unflanged
92.075 -0.000/-0.056	96.830 +0.000/-0.043	120.650 +0.25/-0.25			BP09208-09683-12065-SS6	Bushes - Stainless Steel and PTFE - Unflanged
92.075 -0.000/-0.056	96.830 +0.000/-0.043	120.650 +0.50/-0.50			BP09208-09683-12065-DP4	Bushes - Steel - DP4 - Split - Unflanged
92.075 -0.000/-0.056	96.830 +0.000/-0.043	120.650 +0.50/-0.50			BP09208-09683-12065-DU	Bushes - Steel - DU - Split - Unflanged
95.000 x 100.000 mm (3.740 x 3.937 in.)						
95.000 -0.000/-0.054	100.000 +0.120/-0.000	50.000 +0.50/-0.50			BP09500-10000-05000-DP4	Bushes - Steel - DP4 - Split - Unflanged
95.000 -0.000/-0.054	100.000 +0.120/-0.000	50.000 +0.50/-0.50			BP09500-10000-05000-DU	Bushes - Steel - DU - Split - Unflanged
95.000 -0.000/-0.054	100.000 +0.120/-0.000	50.000 +0.00/-0.40			BP09500-10000-05000-SS6	Bushes - Stainless Steel and PTFE - Unflanged
95.000 -0.000/-0.054	100.000 +0.120/-0.000	60.000 +0.50/-0.50			BP09500-10000-06000-DU	Bushes - Steel - DU - Split - Unflanged
95.000 -0.000/-0.054	100.000 +0.120/-0.000	60.000 +0.00/-0.40			BP09500-10000-06000-SS6	Bushes - Stainless Steel and PTFE - Unflanged
95.000 -0.000/-0.054	100.000 +0.035/-0.000	60.000 +0.50/-0.50			BP09500-10000-06000-DP4	Bushes - Steel - DP4 - Split - Unflanged
95.000 -0.000/-0.054	100.000 +0.120/-0.000	60.000 +0.50/-0.50			BP09500-10000-06000-DX	Bushes - Steel - DX - Split - Unflanged
95.000 -0.000/-0.056	100.000 +0.120/-0.000	80.000 +0.50/-0.50			BP09500-10000-08000-DP4	Bushes - Steel - DP4 - Split - Unflanged
95.000 -0.000/-0.054	100.000 +0.120/-0.000	80.000 +0.50/-0.50			BP09500-10000-08000-DU	Bushes - Steel - DU - Split - Unflanged
95.000 -0.000/-0.054	100.000 +0.120/-0.000	80.000 +0.00/-0.40			BP09500-10000-08000-SS6	Bushes - Stainless Steel and PTFE - Unflanged
95.000 -0.000/-0.054	100.000 +0.120/-0.000	100.000 +0.00/-0.40			BP09500-10000-10000-SS6	Bushes - Stainless Steel and PTFE - Unflanged
95.000 -0.000/-0.054	100.000 +0.035/-0.000	100.000 +0.50/-0.50			BP09500-10000-10000-DP4	Bushes - Steel - DP4 - Split - Unflanged
95.000 -0.000/-0.054	100.000 +0.120/-0.000	100.000 +0.50/-0.50			BP09500-10000-10000-DU	Bushes - Steel - DU - Split - Unflanged
95.000 -0.000/-0.054	100.000 +0.120/-0.000	100.000 +0.50/-0.50			BP09500-10000-10000-DX	Bushes - Steel - DX - Split - Unflanged
95.250 x 99.822 mm (3.750 x 3.930 in.)						
95.250 -0.000/-0.056	99.822 +0.000/-0.043	50.800 +0.50/-0.50			BP09525-09982-05080-DU	Bushes - Steel - DU - Split - Unflanged
95.250 -0.000/-0.056	99.822 +0.000/-0.043	50.800 +0.25/-0.25			BP09525-09982-05080-SS6	Bushes - Stainless Steel and PTFE - Unflanged
95.250 -0.000/-0.056	99.822 +0.000/-0.043	50.800 +0.50/-0.50			BP09525-09982-05080-DP4	Bushes - Steel - DP4 - Split - Unflanged
95.250 -0.000/-0.056	99.822 +0.000/-0.043	57.150 +0.25/-0.25			BP09525-09982-05715-SS6	Bushes - Stainless Steel and PTFE - Unflanged
95.250 -0.000/-0.056	99.822 +0.000/-0.043	57.150 +0.50/-0.50			BP09525-09982-05715-DP4	Bushes - Steel - DP4 - Split - Unflanged
95.250 -0.000/-0.056	99.822 +0.000/-0.043	57.150 +0.50/-0.50			BP09525-09982-05715-DU	Bushes - Steel - DU - Split - Unflanged
95.250 -0.000/-0.056	99.822 +0.000/-0.043	63.500 +0.25/-0.25			BP09525-09982-06350-SS6	Bushes - Stainless Steel and PTFE - Unflanged
95.250 -0.000/-0.056	99.822 +0.000/-0.043	63.500 +0.50/-0.50			BP09525-09982-06350-DP4	Bushes - Steel - DP4 - Split - Unflanged
95.250 -0.000/-0.056	99.822 +0.000/-0.043	63.500 +0.50/-0.50			BP09525-09982-06350-DU	Bushes - Steel - DU - Split - Unflanged
95.250 -0.000/-0.056	99.822 +0.000/-0.043	76.200 +0.50/-0.50			BP09525-09982-07620-DP4	Bushes - Steel - DP4 - Split - Unflanged
95.250 -0.000/-0.056	99.822 +0.000/-0.043	76.200 +0.50/-0.50			BP09525-09982-07620-DU	Bushes - Steel - DU - Split - Unflanged
95.250 -0.000/-0.056	99.822 +0.000/-0.043	76.200 +0.25/-0.25			BP09525-09982-07620-SS6	Bushes - Stainless Steel and PTFE - Unflanged
95.250 -0.000/-0.056	99.822 +0.000/-0.043	88.900 +0.50/-0.50			BP09525-09982-08890-DP4	Bushes - Steel - DP4 - Split - Unflanged
95.250 -0.000/-0.056	99.822 +0.000/-0.043	88.900 +0.50/-0.50			BP09525-09982-08890-DU	Bushes - Steel - DU - Split - Unflanged
95.250 -0.000/-0.056	99.822 +0.000/-0.043	88.900 +0.25/-0.25			BP09525-09982-08890-SS6	Bushes - Stainless Steel and PTFE - Unflanged

 Stocked or Short Delivery

 Usually Available

 Long delivery or not in current production

ID	OD	B	DF	bf	Part Number	Type
95.250 x 99.822 mm (3.750 x 3.930 in.)						
95.250 -0.000/-0.056	99.822 +0.000/-0.043	95.250 +0.50/-0.50			BP09525-09982-09525-DP4	Bushes - Steel - DP4 - Split - Unflanged
95.250 -0.000/-0.056	99.822 +0.000/-0.043	95.250 +0.50/-0.50			BP09525-09982-09525-DU	Bushes - Steel - DU - Split - Unflanged
95.250 -0.000/-0.056	99.822 +0.000/-0.043	95.250 +0.25/-0.25			BP09525-09982-09525-SS6	Bushes - Stainless Steel and PTFE - Unflanged
95.250 -0.000/-0.056	99.822 +0.000/-0.043	101.600 +0.50/-0.50			BP09525-09982-10160-DP4	Bushes - Steel - DP4 - Split - Unflanged
95.250 -0.000/-0.056	99.822 +0.000/-0.043	101.600 +0.50/-0.50			BP09525-09982-10160-DU	Bushes - Steel - DU - Split - Unflanged
95.250 -0.000/-0.056	99.822 +0.000/-0.043	101.600 +0.25/-0.25			BP09525-09982-10160-SS6	Bushes - Stainless Steel and PTFE - Unflanged
95.250 -0.000/-0.056	99.822 +0.000/-0.043	114.300 +0.50/-0.50			BP09525-09982-11430-DP4	Bushes - Steel - DP4 - Split - Unflanged
95.250 -0.000/-0.056	99.822 +0.000/-0.043	114.300 +0.50/-0.50			BP09525-09982-11430-DU	Bushes - Steel - DU - Split - Unflanged
95.250 -0.000/-0.056	99.822 +0.000/-0.043	114.300 +0.25/-0.25			BP09525-09982-11430-SS6	Bushes - Stainless Steel and PTFE - Unflanged
95.250 -0.000/-0.056	99.822 +0.000/-0.043	120.650 +0.50/-0.50			BP09525-09982-12065-DP4	Bushes - Steel - DP4 - Split - Unflanged
95.250 -0.000/-0.056	99.822 +0.000/-0.043	120.650 +0.50/-0.50			BP09525-09982-12065-DU	Bushes - Steel - DU - Split - Unflanged
95.250 -0.000/-0.056	99.822 +0.000/-0.043	120.650 +0.25/-0.25			BP09525-09982-12065-SS6	Bushes - Stainless Steel and PTFE - Unflanged

100.000 x 105.000 mm (3.937 x 4.134 in.)						
100.000 -0.000/-0.054	105.000 +0.120/-0.000	50.000 +0.50/-0.50			BP10000-10500-05000-DX	Bushes - Steel - DX - Split - Unflanged
100.000 -0.000/-0.054	105.000 +0.120/-0.000	50.000 +0.00/-0.40			BP10000-10500-05000-SS6	Bushes - Stainless Steel and PTFE - Unflanged
100.000 -0.000/-0.054	105.000 +0.120/-0.000	50.000 +0.50/-0.50			BP10000-10500-05000-DU	Bushes - Steel - DU - Split - Unflanged
100.000 -0.000/-0.054	105.000 +0.035/-0.000	50.000 +0.50/-0.50			BP10000-10500-05000-DP4	Bushes - Steel - DP4 - Split - Unflanged
100.000 -0.000/-0.054	105.000 +0.120/-0.000	60.000 +0.50/-0.50			BP10000-10500-06000-DU	Bushes - Steel - DU - Split - Unflanged
100.000 -0.000/-0.054	105.000 +0.120/-0.000	60.000 +0.50/-0.50			BP10000-10500-06000-DUB	Bushes - Steel - DUB - Split - Unflanged
100.000 -0.000/-0.054	105.000 +0.120/-0.000	60.000 +0.50/-0.50			BP10000-10500-06000-DX	Bushes - Steel - DX - Split - Unflanged
100.000 -0.000/-0.054	105.000 +0.120/-0.000	60.000 +0.00/-0.40			BP10000-10500-06000-SS6	Bushes - Stainless Steel and PTFE - Unflanged
100.000 -0.000/-0.054	105.000 +0.035/-0.000	60.000 +0.50/-0.50			BP10000-10500-06000-DP4	Bushes - Steel - DP4 - Split - Unflanged
100.000 -0.000/-0.054	105.000 +0.120/-0.000	80.000 +0.50/-0.50			BP10000-10500-08000-DP4	Bushes - Steel - DP4 - Split - Unflanged
100.000 -0.000/-0.054	105.000 +0.120/-0.000	80.000 +0.00/-0.40			BP10000-10500-08000-SS6	Bushes - Stainless Steel and PTFE - Unflanged
100.000 -0.000/-0.054	105.000 +0.120/-0.000	80.000 +0.50/-0.50			BP10000-10500-08000-DU	Bushes - Steel - DU - Split - Unflanged
100.000 -0.000/-0.054	105.000 +0.120/-0.000	80.000 +0.50/-0.50			BP10000-10500-08000-DX	Bushes - Steel - DX - Split - Unflanged
100.000 -0.000/-0.054	105.000 +0.120/-0.000	95.000 +0.50/-0.50			BP10000-10500-09500-DX	Bushes - Steel - DX - Split - Unflanged
100.000 -0.000/-0.054	105.000 +0.035/-0.000	115.000 +0.50/-0.50			BP10000-10500-11500-DP4	Bushes - Steel - DP4 - Split - Unflanged
100.000 -0.000/-0.054	105.000 +0.120/-0.000	115.000 +0.50/-0.50			BP10000-10500-11500-DU	Bushes - Steel - DU - Split - Unflanged
100.000 -0.000/-0.054	105.000 +0.120/-0.000	115.000 +0.50/-0.50			BP10000-10500-11500-DUB	Bushes - Steel - DUB - Split - Unflanged
100.000 -0.000/-0.054	105.000 +0.120/-0.000	115.000 +0.50/-0.50			BP10000-10500-11500-DX	Bushes - Steel - DX - Split - Unflanged
100.000 -0.000/-0.054	105.000 +0.120/-0.000	115.000 +0.00/-0.40			BP10000-10500-11500-SS6	Bushes - Stainless Steel and PTFE - Unflanged

101.600 x 106.350 mm (4.000 x 4.187 in.)						
101.600 -0.000/-0.056	106.350 +0.000/-0.043	50.800 +0.50/-0.50			BP10160-10635-05080-DP4	Bushes - Steel - DP4 - Split - Unflanged
101.600 -0.000/-0.056	106.350 +0.000/-0.043	50.800 +0.50/-0.50			BP10160-10635-05080-DU	Bushes - Steel - DU - Split - Unflanged
101.600 -0.000/-0.056	106.350 +0.000/-0.043	50.800 +0.25/-0.25			BP10160-10635-05080-SS6	Bushes - Stainless Steel and PTFE - Unflanged
101.600 -0.000/-0.056	106.350 +0.000/-0.043	57.150 +0.50/-0.50			BP10160-10635-05715-DP4	Bushes - Steel - DP4 - Split - Unflanged
101.600 -0.000/-0.056	106.350 +0.000/-0.043	57.150 +0.50/-0.50			BP10160-10635-05715-DU	Bushes - Steel - DU - Split - Unflanged
101.600 -0.000/-0.056	106.350 +0.000/-0.043	57.150 +0.25/-0.25			BP10160-10635-05715-SS6	Bushes - Stainless Steel and PTFE - Unflanged
101.600 -0.000/-0.056	106.350 +0.000/-0.043	63.500 +0.50/-0.50			BP10160-10635-06350-DP4	Bushes - Steel - DP4 - Split - Unflanged

 Stocked or Short Delivery

 Usually Available

 Long delivery or not in current production

ID	OD	B	DF	bf	Part Number	Type
101.600 x 106.350 mm (4.000 x 4.187 in.)						
101.600 -0.000/-0.056	106.350 +0.000/-0.043	63.500 +0.25/-0.25			BP10160-10635-06350-SS6	Bushes - Stainless Steel and PTFE - Unflanged
101.600 -0.000/-0.056	106.350 +0.000/-0.043	63.500 +0.50/-0.50			BP10160-10635-06350-DU	Bushes - Steel - DU - Split - Unflanged
101.600 -0.000/-0.056	106.350 +0.000/-0.043	76.200 +0.50/-0.50			BP10160-10635-07620-DP4	Bushes - Steel - DP4 - Split - Unflanged
101.600 -0.000/-0.056	106.350 +0.000/-0.043	76.200 +0.50/-0.50			BP10160-10635-07620-DU	Bushes - Steel - DU - Split - Unflanged
101.600 -0.000/-0.056	106.350 +0.000/-0.043	76.200 +0.25/-0.25			BP10160-10635-07620-SS6	Bushes - Stainless Steel and PTFE - Unflanged
101.600 -0.000/-0.056	106.350 +0.000/-0.043	88.900 +0.50/-0.50			BP10160-10635-08890-DP4	Bushes - Steel - DP4 - Split - Unflanged
101.600 -0.000/-0.056	106.350 +0.000/-0.043	88.900 +0.50/-0.50			BP10160-10635-08890-DU	Bushes - Steel - DU - Split - Unflanged
101.600 -0.000/-0.056	106.350 +0.000/-0.043	88.900 +0.25/-0.25			BP10160-10635-08890-SS6	Bushes - Stainless Steel and PTFE - Unflanged
101.600 -0.000/-0.056	106.350 +0.000/-0.043	95.250 +0.50/-0.50			BP10160-10635-09525-DP4	Bushes - Steel - DP4 - Split - Unflanged
101.600 -0.000/-0.056	106.350 +0.000/-0.043	95.250 +0.50/-0.50			BP10160-10635-09525-DU	Bushes - Steel - DU - Split - Unflanged
101.600 -0.000/-0.056	106.350 +0.000/-0.043	95.250 +0.25/-0.25			BP10160-10635-09525-SS6	Bushes - Stainless Steel and PTFE - Unflanged
101.600 -0.000/-0.056	106.350 +0.000/-0.043	101.600 +0.50/-0.50			BP10160-10635-10160-DP4	Bushes - Steel - DP4 - Split - Unflanged
101.600 -0.000/-0.056	106.350 +0.000/-0.043	101.600 +0.50/-0.50			BP10160-10635-10160-DU	Bushes - Steel - DU - Split - Unflanged
101.600 -0.000/-0.056	106.350 +0.000/-0.043	101.600 +0.25/-0.25			BP10160-10635-10160-SS6	Bushes - Stainless Steel and PTFE - Unflanged
101.600 -0.000/-0.056	106.350 +0.000/-0.043	114.300 +0.50/-0.50			BP10160-10635-11430-DP4	Bushes - Steel - DP4 - Split - Unflanged
101.600 -0.000/-0.056	106.350 +0.000/-0.043	114.300 +0.25/-0.25			BP10160-10635-11430-SS6	Bushes - Stainless Steel and PTFE - Unflanged
101.600 -0.000/-0.056	106.350 +0.000/-0.043	114.300 +0.50/-0.50			BP10160-10635-11430-DU	Bushes - Steel - DU - Split - Unflanged
101.600 -0.000/-0.056	106.350 +0.000/-0.043	120.650 +0.50/-0.50			BP10160-10635-12065-DP4	Bushes - Steel - DP4 - Split - Unflanged
101.600 -0.000/-0.056	106.350 +0.000/-0.043	120.650 +0.50/-0.50			BP10160-10635-12065-DU	Bushes - Steel - DU - Split - Unflanged
101.600 -0.000/-0.056	106.350 +0.000/-0.043	120.650 +0.25/-0.25			BP10160-10635-12065-SS6	Bushes - Stainless Steel and PTFE - Unflanged
101.600 x 114.300 mm (4.000 x 4.500 in.)						
101.600 +0.089/+0.026	114.300 +0.038/+0.102	101.600 +/-0.254			BP10160-11430-10160-BS	Bushes - Bronze - Sintered - Unflanged
105.000 x 110.000 mm (4.134 x 4.331 in.)						
105.000 -0.000/-0.054	110.000 +0.120/-0.000	60.000 +0.50/-0.50			BP10500-11000-06000-DU	Bushes - Steel - DU - Split - Unflanged
105.000 -0.000/-0.054	110.000 +0.120/-0.000	60.000 +0.50/-0.50			BP10500-11000-06000-DX	Bushes - Steel - DX - Split - Unflanged
105.000 -0.000/-0.054	110.000 +0.035/-0.000	60.000 +0.50/-0.50			BP10500-11000-06000-DP4	Bushes - Steel - DP4 - Split - Unflanged
105.000 -0.000/-0.054	110.000 +0.120/-0.000	60.000 +0.00/-0.40			BP10500-11000-06000-SS6	Bushes - Stainless Steel and PTFE - Unflanged
105.000 -0.000/-0.054	110.000 +0.120/-0.000	80.000 +0.50/-0.50			BP10500-11000-08000-DP4	Bushes - Steel - DP4 - Split - Unflanged
105.000 -0.000/-0.054	110.000 +0.120/-0.000	80.000 +0.50/-0.50			BP10500-11000-08000-DU	Bushes - Steel - DU - Split - Unflanged
105.000 -0.000/-0.054	110.000 +0.120/-0.000	80.000 +0.00/-0.40			BP10500-11000-08000-SS6	Bushes - Stainless Steel and PTFE - Unflanged
105.000 -0.000/-0.054	110.000 +0.120/-0.000	110.000 +0.50/-0.50			BP10500-11000-11000-DX	Bushes - Steel - DX - Split - Unflanged
105.000 -0.000/-0.054	110.000 +0.035/-0.000	115.000 +0.50/-0.50			BP10500-11000-11500-DP4	Bushes - Steel - DP4 - Split - Unflanged
105.000 -0.000/-0.054	110.000 +0.120/-0.000	115.000 +0.00/-0.40			BP10500-11000-11500-SS6	Bushes - Stainless Steel and PTFE - Unflanged
105.000 -0.000/-0.054	110.000 +0.120/-0.000	115.000 +0.50/-0.50			BP10500-11000-11500-DU	Bushes - Steel - DU - Split - Unflanged
105.000 -0.000/-0.054	110.000 +0.120/-0.000	115.000 +0.50/-0.50			BP10500-11000-11500-DX	Bushes - Steel - DX - Split - Unflanged
107.950 x 112.700 mm (4.250 x 4.437 in.)						
107.950 -0.000/-0.056	112.700 +0.000/-0.043	50.800 +0.50/-0.50			BP10795-11270-05080-DP4	Bushes - Steel - DP4 - Split - Unflanged
107.950 -0.000/-0.056	112.700 +0.000/-0.043	50.800 +0.50/-0.50			BP10795-11270-05080-DU	Bushes - Steel - DU - Split - Unflanged
107.950 -0.000/-0.056	112.700 +0.000/-0.043	50.800 +0.25/-0.25			BP10795-11270-05080-SS6	Bushes - Stainless Steel and PTFE - Unflanged
107.950 -0.000/-0.056	112.700 +0.000/-0.043	57.150 +0.50/-0.50			BP10795-11270-05715-DP4	Bushes - Steel - DP4 - Split - Unflanged

 Stocked or Short Delivery

 Usually Available

 Long delivery or not in current production

ID	OD	B	DF	bf	Part Number	Type
107.950 x 112.700 mm (4.250 x 4.437 in.)						
107.950 -0.000/-0.056	112.700 +0.000/-0.043	57.150 +0.50/-0.50			BP10795-11270-05715-DU	Bushes - Steel - DU - Split - Unflanged
107.950 -0.000/-0.056	112.700 +0.000/-0.043	57.150 +0.25/-0.25			BP10795-11270-05715-SS6	Bushes - Stainless Steel and PTFE - Unflanged
107.950 -0.000/-0.056	112.700 +0.000/-0.043	63.500 +0.50/-0.50			BP10795-11270-06350-DP4	Bushes - Steel - DP4 - Split - Unflanged
107.950 -0.000/-0.056	112.700 +0.000/-0.043	63.500 +0.50/-0.50			BP10795-11270-06350-DU	Bushes - Steel - DU - Split - Unflanged
107.950 -0.000/-0.056	112.700 +0.000/-0.043	63.500 +0.25/-0.25			BP10795-11270-06350-SS6	Bushes - Stainless Steel and PTFE - Unflanged
107.950 -0.000/-0.056	112.700 +0.000/-0.043	76.200 +0.50/-0.50			BP10795-11270-07620-DP4	Bushes - Steel - DP4 - Split - Unflanged
107.950 -0.000/-0.056	112.700 +0.000/-0.043	76.200 +0.50/-0.50			BP10795-11270-07620-DU	Bushes - Steel - DU - Split - Unflanged
107.950 -0.000/-0.056	112.700 +0.000/-0.043	76.200 +0.25/-0.25			BP10795-11270-07620-SS6	Bushes - Stainless Steel and PTFE - Unflanged
107.950 -0.000/-0.056	112.700 +0.000/-0.043	88.900 +0.50/-0.50			BP10795-11270-08890-DP4	Bushes - Steel - DP4 - Split - Unflanged
107.950 -0.000/-0.056	112.700 +0.000/-0.043	88.900 +0.50/-0.50			BP10795-11270-08890-DU	Bushes - Steel - DU - Split - Unflanged
107.950 -0.000/-0.056	112.700 +0.000/-0.043	88.900 +0.25/-0.25			BP10795-11270-08890-SS6	Bushes - Stainless Steel and PTFE - Unflanged
107.950 -0.000/-0.056	112.700 +0.000/-0.043	95.250 +0.50/-0.50			BP10795-11270-09525-DP4	Bushes - Steel - DP4 - Split - Unflanged
107.950 -0.000/-0.056	112.700 +0.000/-0.043	95.250 +0.50/-0.50			BP10795-11270-09525-DU	Bushes - Steel - DU - Split - Unflanged
107.950 -0.000/-0.056	112.700 +0.000/-0.043	95.250 +0.25/-0.25			BP10795-11270-09525-SS6	Bushes - Stainless Steel and PTFE - Unflanged
107.950 -0.000/-0.056	112.700 +0.000/-0.043	101.600 +0.25/-0.25			BP10795-11270-10160-SS6	Bushes - Stainless Steel and PTFE - Unflanged
107.950 -0.000/-0.056	112.700 +0.000/-0.043	101.600 +0.50/-0.50			BP10795-11270-10160-DP4	Bushes - Steel - DP4 - Split - Unflanged
107.950 -0.000/-0.056	112.700 +0.000/-0.043	101.600 +0.50/-0.50			BP10795-11270-10160-DU	Bushes - Steel - DU - Split - Unflanged
107.950 -0.000/-0.056	112.700 +0.000/-0.043	114.300 +0.25/-0.25			BP10795-11270-11430-SS6	Bushes - Stainless Steel and PTFE - Unflanged
107.950 -0.000/-0.056	112.700 +0.000/-0.043	114.300 +0.50/-0.50			BP10795-11270-11430-DP4	Bushes - Steel - DP4 - Split - Unflanged
107.950 -0.000/-0.056	112.700 +0.000/-0.043	114.300 +0.50/-0.50			BP10795-11270-11430-DU	Bushes - Steel - DU - Split - Unflanged
107.950 -0.000/-0.056	112.700 +0.000/-0.043	120.650 +0.50/-0.50			BP10795-11270-12065-DP4	Bushes - Steel - DP4 - Split - Unflanged
107.950 -0.000/-0.056	112.700 +0.000/-0.043	120.650 +0.50/-0.50			BP10795-11270-12065-DU	Bushes - Steel - DU - Split - Unflanged
107.950 -0.000/-0.056	112.700 +0.000/-0.043	120.650 +0.25/-0.25			BP10795-11270-12065-SS6	Bushes - Stainless Steel and PTFE - Unflanged

110.000 x 115.000 mm (4.331 x 4.528 in.)						
110.000 -0.000/-0.054	115.000 +0.035/-0.000	60.000 +0.50/-0.50			BP11000-11500-06000-DP4	Bushes - Steel - DP4 - Split - Unflanged
110.000 -0.000/-0.054	115.000 +0.120/-0.000	60.000 +0.00/-0.40			BP11000-11500-06000-SS6	Bushes - Stainless Steel and PTFE - Unflanged
110.000 -0.000/-0.054	115.000 +0.120/-0.000	60.000 +0.50/-0.50			BP11000-11500-06000-DX	Bushes - Steel - DX - Split - Unflanged
110.000 -0.000/-0.054	115.000 +0.120/-0.000	60.000 +0.50/-0.50			BP11000-11500-06000-DU	Bushes - Steel - DU - Split - Unflanged
110.000 -0.000/-0.054	115.000 +0.120/-0.000	80.000 +0.50/-0.50			BP11000-11500-08000-DP4	Bushes - Steel - DP4 - Split - Unflanged
110.000 -0.000/-0.054	115.000 +0.120/-0.000	80.000 +0.50/-0.50			BP11000-11500-08000-DU	Bushes - Steel - DU - Split - Unflanged
110.000 -0.000/-0.054	115.000 +0.120/-0.000	80.000 +0.00/-0.40			BP11000-11500-08000-SS6	Bushes - Stainless Steel and PTFE - Unflanged
110.000 -0.000/-0.054	115.000 +0.120/-0.000	110.000 +0.50/-0.50			BP11000-11500-11000-DX	Bushes - Steel - DX - Split - Unflanged
110.000 -0.000/-0.054	115.000 +0.035/-0.000	115.000 +0.50/-0.50			BP11000-11500-11500-DP4	Bushes - Steel - DP4 - Split - Unflanged
110.000 -0.000/-0.054	115.000 +0.120/-0.000	115.000 +0.50/-0.50			BP11000-11500-11500-DU	Bushes - Steel - DU - Split - Unflanged
110.000 -0.000/-0.054	115.000 +0.120/-0.000	115.000 +0.50/-0.50			BP11000-11500-11500-DX	Bushes - Steel - DX - Split - Unflanged
110.000 -0.000/-0.054	115.000 +0.120/-0.000	115.000 +0.00/-0.40			BP11000-11500-11500-SS6	Bushes - Stainless Steel and PTFE - Unflanged

111.125 x 115.824 mm (4.375 x 4.560 in.)						
111.125 -0.000/-0.056	115.824 +0.000/-0.043	50.800 +0.50/-0.50			BP11113-11582-05080-DP4	Bushes - Steel - DP4 - Split - Unflanged
111.125 -0.000/-0.056	115.824 +0.000/-0.043	50.800 +0.50/-0.50			BP11113-11582-05080-DU	Bushes - Steel - DU - Split - Unflanged
111.125 -0.000/-0.056	115.824 +0.000/-0.043	50.800 +0.25/-0.25			BP11113-11582-05080-SS6	Bushes - Stainless Steel and PTFE - Unflanged

 Stocked or Short Delivery

 Usually Available

 Long delivery or not in current production

ID	OD	B	DF	bf	Part Number	Type
111.125 x 115.824 mm (4.375 x 4.560 in.)						
111.125 -0.000/-0.056	115.824 +0.000/-0.043	57.150 +0.50/-0.50			BP11113-11582-05715-DU	Bushes - Steel - DU - Split - Unflanged
111.125 -0.000/-0.056	115.824 +0.000/-0.043	57.150 +0.25/-0.25			BP11113-11582-05715-SS6	Bushes - Stainless Steel and PTFE - Unflanged
111.125 -0.000/-0.056	115.824 +0.000/-0.043	57.150 +0.50/-0.50			BP11113-11582-05715-DP4	Bushes - Steel - DP4 - Split - Unflanged
111.125 -0.000/-0.056	115.824 +0.000/-0.043	63.500 +0.50/-0.50			BP11113-11582-06350-DU	Bushes - Steel - DU - Split - Unflanged
111.125 -0.000/-0.056	115.824 +0.000/-0.043	63.500 +0.25/-0.25			BP11113-11582-06350-SS6	Bushes - Stainless Steel and PTFE - Unflanged
111.125 -0.000/-0.056	115.824 +0.000/-0.043	63.500 +0.50/-0.50			BP11113-11582-06350-DP4	Bushes - Steel - DP4 - Split - Unflanged
111.125 -0.000/-0.056	115.824 +0.000/-0.043	76.200 +0.50/-0.50			BP11113-11582-07620-DP4	Bushes - Steel - DP4 - Split - Unflanged
111.125 -0.000/-0.056	115.824 +0.000/-0.043	76.200 +0.50/-0.50			BP11113-11582-07620-DU	Bushes - Steel - DU - Split - Unflanged
111.125 -0.000/-0.056	115.824 +0.000/-0.043	76.200 +0.25/-0.25			BP11113-11582-07620-SS6	Bushes - Stainless Steel and PTFE - Unflanged
111.125 -0.000/-0.056	115.824 +0.000/-0.043	88.900 +0.50/-0.50			BP11113-11582-08890-DP4	Bushes - Steel - DP4 - Split - Unflanged
111.125 -0.000/-0.056	115.824 +0.000/-0.043	88.900 +0.50/-0.50			BP11113-11582-08890-DU	Bushes - Steel - DU - Split - Unflanged
111.125 -0.000/-0.056	115.824 +0.000/-0.043	88.900 +0.25/-0.25			BP11113-11582-08890-SS6	Bushes - Stainless Steel and PTFE - Unflanged
111.125 -0.000/-0.056	115.824 +0.000/-0.043	95.250 +0.50/-0.50			BP11113-11582-09525-DP4	Bushes - Steel - DP4 - Split - Unflanged
111.125 -0.000/-0.056	115.824 +0.000/-0.043	95.250 +0.50/-0.50			BP11113-11582-09525-DU	Bushes - Steel - DU - Split - Unflanged
111.125 -0.000/-0.056	115.824 +0.000/-0.043	95.250 +0.25/-0.25			BP11113-11582-09525-SS6	Bushes - Stainless Steel and PTFE - Unflanged
111.125 -0.000/-0.056	115.824 +0.000/-0.043	101.600 +0.50/-0.50			BP11113-11582-10160-DU	Bushes - Steel - DU - Split - Unflanged
111.125 -0.000/-0.056	115.824 +0.000/-0.043	101.600 +0.25/-0.25			BP11113-11582-10160-SS6	Bushes - Stainless Steel and PTFE - Unflanged
111.125 -0.000/-0.056	115.824 +0.000/-0.043	101.600 +0.50/-0.50			BP11113-11582-10160-DP4	Bushes - Steel - DP4 - Split - Unflanged
111.125 -0.000/-0.056	115.824 +0.000/-0.043	114.300 +0.50/-0.50			BP11113-11582-11430-DP4	Bushes - Steel - DP4 - Split - Unflanged
111.125 -0.000/-0.056	115.824 +0.000/-0.043	114.300 +0.50/-0.50			BP11113-11582-11430-DU	Bushes - Steel - DU - Split - Unflanged
111.125 -0.000/-0.056	115.824 +0.000/-0.043	114.300 +0.25/-0.25			BP11113-11582-11430-SS6	Bushes - Stainless Steel and PTFE - Unflanged
111.125 -0.000/-0.056	115.824 +0.000/-0.043	120.650 +0.50/-0.50			BP11113-11582-12065-DP4	Bushes - Steel - DP4 - Split - Unflanged
111.125 -0.000/-0.056	115.824 +0.000/-0.043	120.650 +0.50/-0.50			BP11113-11582-12065-DU	Bushes - Steel - DU - Split - Unflanged
111.125 -0.000/-0.056	115.824 +0.000/-0.043	120.650 +0.25/-0.25			BP11113-11582-12065-SS6	Bushes - Stainless Steel and PTFE - Unflanged

114.300 x 118.872 mm (4.500 x 4.680 in.)						
114.300 -0.000/-0.056	118.872 +0.000/-0.043	50.800 +0.50/-0.50			BP11430-11887-05080-DP4	Bushes - Steel - DP4 - Split - Unflanged
114.300 -0.000/-0.056	118.872 +0.000/-0.043	50.800 +0.50/-0.50			BP11430-11887-05080-DU	Bushes - Steel - DU - Split - Unflanged
114.300 -0.000/-0.056	118.872 +0.000/-0.043	50.800 +0.25/-0.25			BP11430-11887-05080-SS6	Bushes - Stainless Steel and PTFE - Unflanged
114.300 -0.000/-0.056	118.872 +0.000/-0.043	57.150 +0.50/-0.50			BP11430-11887-05715-DP4	Bushes - Steel - DP4 - Split - Unflanged
114.300 -0.000/-0.056	118.872 +0.000/-0.043	57.150 +0.50/-0.50			BP11430-11887-05715-DU	Bushes - Steel - DU - Split - Unflanged
114.300 -0.000/-0.056	118.872 +0.000/-0.043	57.150 +0.25/-0.25			BP11430-11887-05715-SS6	Bushes - Stainless Steel and PTFE - Unflanged
114.300 -0.000/-0.056	118.872 +0.000/-0.043	63.500 +0.50/-0.50			BP11430-11887-06350-DU	Bushes - Steel - DU - Split - Unflanged
114.300 -0.000/-0.056	118.872 +0.000/-0.043	63.500 +0.25/-0.25			BP11430-11887-06350-SS6	Bushes - Stainless Steel and PTFE - Unflanged
114.300 -0.000/-0.056	118.872 +0.000/-0.043	63.500 +0.50/-0.50			BP11430-11887-06350-DP4	Bushes - Steel - DP4 - Split - Unflanged
114.300 -0.000/-0.056	118.872 +0.000/-0.043	76.200 +0.50/-0.50			BP11430-11887-07620-DU	Bushes - Steel - DU - Split - Unflanged
114.300 -0.000/-0.056	118.872 +0.000/-0.043	76.200 +0.25/-0.25			BP11430-11887-07620-SS6	Bushes - Stainless Steel and PTFE - Unflanged
114.300 -0.000/-0.056	118.872 +0.000/-0.043	76.200 +0.50/-0.50			BP11430-11887-07620-DP4	Bushes - Steel - DP4 - Split - Unflanged
114.300 -0.000/-0.056	118.872 +0.000/-0.043	88.900 +0.50/-0.50			BP11430-11887-08890-DP4	Bushes - Steel - DP4 - Split - Unflanged
114.300 -0.000/-0.056	118.872 +0.000/-0.043	88.900 +0.50/-0.50			BP11430-11887-08890-DU	Bushes - Steel - DU - Split - Unflanged
114.300 -0.000/-0.056	118.872 +0.000/-0.043	88.900 +0.25/-0.25			BP11430-11887-08890-SS6	Bushes - Stainless Steel and PTFE - Unflanged
114.300 -0.000/-0.056	118.872 +0.000/-0.043	95.250 +0.50/-0.50			BP11430-11887-09525-DP4	Bushes - Steel - DP4 - Split - Unflanged

 Stocked or Short Delivery

 Usually Available

 Long delivery or not in current production

ID	OD	B	DF	bf	Part Number	Type
114.300 x 118.872 mm (4.500 x 4.680 in.)						
114.300 -0.000/-0.056	118.872 +0.000/-0.043	95.250 +0.50/-0.50			BP11430-11887-09525-DU	Bushes - Steel - DU - Split - Unflanged
114.300 -0.000/-0.056	118.872 +0.000/-0.043	95.250 +0.25/-0.25			BP11430-11887-09525-SS6	Bushes - Stainless Steel and PTFE - Unflanged
114.300 -0.000/-0.056	118.872 +0.000/-0.043	101.600 +0.50/-0.50			BP11430-11887-10160-DP4	Bushes - Steel - DP4 - Split - Unflanged
114.300 -0.000/-0.056	118.872 +0.000/-0.043	101.600 +0.50/-0.50			BP11430-11887-10160-DU	Bushes - Steel - DU - Split - Unflanged
114.300 -0.000/-0.056	118.872 +0.000/-0.043	101.600 +0.25/-0.25			BP11430-11887-10160-SS6	Bushes - Stainless Steel and PTFE - Unflanged
114.300 -0.000/-0.056	118.872 +0.000/-0.043	114.300 +0.50/-0.50			BP11430-11887-11430-DU	Bushes - Steel - DU - Split - Unflanged
114.300 -0.000/-0.056	118.872 +0.000/-0.043	114.300 +0.25/-0.25			BP11430-11887-11430-SS6	Bushes - Stainless Steel and PTFE - Unflanged
114.300 -0.000/-0.056	118.872 +0.000/-0.043	114.300 +0.50/-0.50			BP11430-11887-11430-DP4	Bushes - Steel - DP4 - Split - Unflanged
114.300 -0.000/-0.056	118.872 +0.000/-0.043	120.650 +0.50/-0.50			BP11430-11887-12065-DU	Bushes - Steel - DU - Split - Unflanged
114.300 -0.000/-0.056	118.872 +0.000/-0.043	120.650 +0.25/-0.25			BP11430-11887-12065-SS6	Bushes - Stainless Steel and PTFE - Unflanged
114.300 -0.000/-0.056	118.872 +0.000/-0.043	120.650 +0.50/-0.50			BP11430-11887-12065-DP4	Bushes - Steel - DP4 - Split - Unflanged
115.000 x 120.000 mm (4.528 x 4.724 in.)						
115.000 -0.000/-0.054	120.000 +0.035/-0.000	50.000 +0.50/-0.50			BP11500-12000-05000-DP4	Bushes - Steel - DP4 - Split - Unflanged
115.000 -0.000/-0.054	120.000 +0.170/-0.000	50.000 +0.50/-0.50			BP11500-12000-05000-DU	Bushes - Steel - DU - Split - Unflanged
115.000 -0.000/-0.054	120.000 +0.170/-0.000	50.000 +0.50/-0.50			BP11500-12000-05000-DX	Bushes - Steel - DX - Split - Unflanged
115.000 -0.000/-0.054	120.000 +0.035/-0.000	70.000 +0.50/-0.50			BP11500-12000-07000-DP4	Bushes - Steel - DP4 - Split - Unflanged
115.000 -0.000/-0.054	120.000 +0.170/-0.000	70.000 +0.50/-0.50			BP11500-12000-07000-DU	Bushes - Steel - DU - Split - Unflanged
115.000 -0.000/-0.054	120.000 +0.170/-0.000	70.000 +0.50/-0.50			BP11500-12000-07000-DX	Bushes - Steel - DX - Split - Unflanged
120.000 x 125.000 mm (4.724 x 4.921 in.)						
120.000 -0.000/-0.054	125.000 +0.170/-0.000	50.000 +0.50/-0.50			BP12000-12500-05000-DU	Bushes - Steel - DU - Split - Unflanged
120.000 -0.000/-0.054	125.000 +0.170/-0.000	60.000 +0.00/-0.40			BP12000-12500-06000-SS6	Bushes - Stainless Steel and PTFE - Unflanged
120.000 -0.000/-0.054	125.000 +0.170/-0.000	60.000 +0.50/-0.50			BP12000-12500-06000-DP4	Bushes - Steel - DP4 - Split - Unflanged
120.000 -0.000/-0.054	125.000 +0.170/-0.000	60.000 +0.50/-0.50			BP12000-12500-06000-DU	Bushes - Steel - DU - Split - Unflanged
120.000 -0.000/-0.054	125.000 +0.170/-0.000	60.000 +0.50/-0.50			BP12000-12500-06000-DX	Bushes - Steel - DX - Split - Unflanged
120.000 -0.000/-0.054	125.000 +0.170/-0.000	80.000 +0.00/-0.40			BP12000-12500-08000-SS6	Bushes - Stainless Steel and PTFE - Unflanged
120.000 -0.000/-0.054	125.000 +0.170/-0.000	80.000 +0.50/-0.50			BP12000-12500-08000-DP4	Bushes - Steel - DP4 - Split - Unflanged
120.000 -0.000/-0.054	125.000 +0.170/-0.000	80.000 +0.50/-0.50			BP12000-12500-08000-DU	Bushes - Steel - DU - Split - Unflanged
120.000 -0.000/-0.054	125.000 +0.170/-0.000	100.000 +0.50/-0.50			BP12000-12500-10000-DP4	Bushes - Steel - DP4 - Split - Unflanged
120.000 -0.000/-0.054	125.000 +0.170/-0.000	100.000 +0.50/-0.50			BP12000-12500-10000-DU	Bushes - Steel - DU - Split - Unflanged
120.000 -0.000/-0.054	125.000 +0.170/-0.000	100.000 +0.50/-0.50			BP12000-12500-10000-DX	Bushes - Steel - DX - Split - Unflanged
120.000 -0.000/-0.054	125.000 +0.170/-0.000	100.000 +0.00/-0.40			BP12000-12500-10000-SS6	Bushes - Stainless Steel and PTFE - Unflanged
120.000 -0.000/-0.054	125.000 +0.170/-0.000	110.000 +0.50/-0.50			BP12000-12500-11000-DX	Bushes - Steel - DX - Split - Unflanged
120.650 x 125.222 mm (4.750 x 4.930 in.)						
120.650 -0.000/-0.056	125.222 +0.000/-0.043	50.800 +0.50/-0.50			BP12065-12522-05080-DP4	Bushes - Steel - DP4 - Split - Unflanged
120.650 -0.000/-0.056	125.222 +0.000/-0.043	50.800 +0.50/-0.50			BP12065-12522-05080-DU	Bushes - Steel - DU - Split - Unflanged
120.650 -0.000/-0.056	125.222 +0.000/-0.043	50.800 +0.25/-0.25			BP12065-12522-05080-SS6	Bushes - Stainless Steel and PTFE - Unflanged
120.650 -0.000/-0.056	125.222 +0.000/-0.043	57.150 +0.50/-0.50			BP12065-12522-05715-DP4	Bushes - Steel - DP4 - Split - Unflanged
120.650 -0.000/-0.056	125.222 +0.000/-0.043	57.150 +0.50/-0.50			BP12065-12522-05715-DU	Bushes - Steel - DU - Split - Unflanged
120.650 -0.000/-0.056	125.222 +0.000/-0.043	57.150 +0.25/-0.25			BP12065-12522-05715-SS6	Bushes - Stainless Steel and PTFE - Unflanged
120.650 -0.000/-0.056	125.222 +0.000/-0.043	63.500 +0.50/-0.50			BP12065-12522-06350-DU	Bushes - Steel - DU - Split - Unflanged

 Stocked or Short Delivery

 Usually Available

 Long delivery or not in current production

ID	OD	B	DF	bf	Part Number	Type
120.650 x 125.222 mm (4.750 x 4.930 in.)						
120.650 -0.000/-0.056	125.222 +0.000/-0.043	63.500 +0.25/-0.25			BP12065-12522-06350-SS6	Bushes - Stainless Steel and PTFE - Unflanged
120.650 -0.000/-0.056	125.222 +0.000/-0.043	63.500 +0.50/-0.50			BP12065-12522-06350-DP4	Bushes - Steel - DP4 - Split - Unflanged
120.650 -0.000/-0.056	125.222 +0.000/-0.043	76.200 +0.50/-0.50			BP12065-12522-07620-DU	Bushes - Steel - DU - Split - Unflanged
120.650 -0.000/-0.056	125.222 +0.000/-0.043	76.200 +0.25/-0.25			BP12065-12522-07620-SS6	Bushes - Stainless Steel and PTFE - Unflanged
120.650 -0.000/-0.056	125.222 +0.000/-0.043	76.200 +0.50/-0.50			BP12065-12522-07620-DP4	Bushes - Steel - DP4 - Split - Unflanged
120.650 -0.000/-0.056	125.222 +0.000/-0.043	88.900 +0.50/-0.50			BP12065-12522-08890-DP4	Bushes - Steel - DP4 - Split - Unflanged
120.650 -0.000/-0.056	125.222 +0.000/-0.043	88.900 +0.50/-0.50			BP12065-12522-08890-DU	Bushes - Steel - DU - Split - Unflanged
120.650 -0.000/-0.056	125.222 +0.000/-0.043	88.900 +0.25/-0.25			BP12065-12522-08890-SS6	Bushes - Stainless Steel and PTFE - Unflanged
120.650 -0.000/-0.056	125.222 +0.000/-0.043	95.250 +0.50/-0.50			BP12065-12522-09525-DP4	Bushes - Steel - DP4 - Split - Unflanged
120.650 -0.000/-0.056	125.222 +0.000/-0.043	95.250 +0.50/-0.50			BP12065-12522-09525-DU	Bushes - Steel - DU - Split - Unflanged
120.650 -0.000/-0.056	125.222 +0.000/-0.043	95.250 +0.25/-0.25			BP12065-12522-09525-SS6	Bushes - Stainless Steel and PTFE - Unflanged
120.650 -0.000/-0.056	125.222 +0.000/-0.043	101.600 +0.50/-0.50			BP12065-12522-10160-DP4	Bushes - Steel - DP4 - Split - Unflanged
120.650 -0.000/-0.056	125.222 +0.000/-0.043	101.600 +0.50/-0.50			BP12065-12522-10160-DU	Bushes - Steel - DU - Split - Unflanged
120.650 -0.000/-0.056	125.222 +0.000/-0.043	101.600 +0.25/-0.25			BP12065-12522-10160-SS6	Bushes - Stainless Steel and PTFE - Unflanged
120.650 -0.000/-0.056	125.222 +0.000/-0.043	114.300 +0.25/-0.25			BP12065-12522-11430-SS6	Bushes - Stainless Steel and PTFE - Unflanged
120.650 -0.000/-0.056	125.222 +0.000/-0.043	114.300 +0.50/-0.50			BP12065-12522-11430-DP4	Bushes - Steel - DP4 - Split - Unflanged
120.650 -0.000/-0.056	125.222 +0.000/-0.043	114.300 +0.50/-0.50			BP12065-12522-11430-DU	Bushes - Steel - DU - Split - Unflanged
120.650 -0.000/-0.056	125.222 +0.000/-0.043	120.650 +0.25/-0.25			BP12065-12522-12065-SS6	Bushes - Stainless Steel and PTFE - Unflanged
120.650 -0.000/-0.056	125.222 +0.000/-0.043	120.650 +0.50/-0.50			BP12065-12522-12065-DP4	Bushes - Steel - DP4 - Split - Unflanged
120.650 -0.000/-0.056	125.222 +0.000/-0.043	120.650 +0.50/-0.50			BP12065-12522-12065-DU	Bushes - Steel - DU - Split - Unflanged
125.000 x 130.000 mm (4.921 x 5.118 in.)						
125.000 -0.000/-0.063	130.000 +0.170/-0.000	60.000 +0.50/-0.50			BP12500-13000-06000-DP4	Bushes - Steel - DP4 - Split - Unflanged
125.000 -0.000/-0.063	130.000 +0.170/-0.000	60.000 +0.50/-0.50			BP12500-13000-06000-DU	Bushes - Steel - DU - Split - Unflanged
125.000 -0.000/-0.063	130.000 +0.170/-0.000	60.000 +0.00/-0.40			BP12500-13000-06000-SS6	Bushes - Stainless Steel and PTFE - Unflanged
125.000 -0.000/-0.063	130.000 +0.170/-0.000	60.000 +0.50/-0.50			BP12500-13000-06000-DX	Bushes - Steel - DX - Split - Unflanged
125.000 -0.000/-0.063	130.000 +0.170/-0.000	100.000 +0.50/-0.50			BP12500-13000-10000-DP4	Bushes - Steel - DP4 - Split - Unflanged
125.000 -0.000/-0.063	130.000 +0.170/-0.000	100.000 +0.50/-0.50			BP12500-13000-10000-DU	Bushes - Steel - DU - Split - Unflanged
125.000 -0.000/-0.063	130.000 +0.170/-0.000	100.000 +0.00/-0.40			BP12500-13000-10000-SS6	Bushes - Stainless Steel and PTFE - Unflanged
125.000 -0.000/-0.063	130.000 +0.170/-0.000	100.000 +0.50/-0.50			BP12500-13000-10000-DX	Bushes - Steel - DX - Split - Unflanged
125.000 -0.000/-0.063	130.000 +0.170/-0.000	110.000 +0.50/-0.50			BP12500-13000-11000-DX	Bushes - Steel - DX - Split - Unflanged
125.000 -0.000/-0.063	130.000 +0.170/-0.000	115.000 +0.00/-0.40			BP12500-13000-11500-SS6	Bushes - Stainless Steel and PTFE - Unflanged
125.000 -0.000/-0.063	130.000 +0.170/-0.000	115.000 +0.50/-0.50			BP12500-13000-11500-DP4	Bushes - Steel - DP4 - Split - Unflanged
125.000 -0.000/-0.063	130.000 +0.170/-0.000	115.000 +0.50/-0.50			BP12500-13000-11500-DU	Bushes - Steel - DU - Split - Unflanged
127.000 x 131.572 mm (5.000 x 5.180 in.)						
127.000 -0.000/-0.099	131.572 +0.000/-0.079	50.800 +0.25/-0.25			BP12700-13157-05080-SS6	Bushes - Stainless Steel and PTFE - Unflanged
127.000 -0.000/-0.099	131.572 +0.000/-0.079	50.800 +0.50/-0.50			BP12700-13157-05080-DU	Bushes - Steel - DU - Split - Unflanged
127.000 -0.000/-0.099	131.572 +0.000/-0.079	50.800 +0.50/-0.50			BP12700-13157-05080-DP4	Bushes - Steel - DP4 - Split - Unflanged
127.000 -0.000/-0.099	131.572 +0.000/-0.079	57.150 +0.50/-0.50			BP12700-13157-05715-DP4	Bushes - Steel - DP4 - Split - Unflanged
127.000 -0.000/-0.099	131.572 +0.000/-0.079	57.150 +0.50/-0.50			BP12700-13157-05715-DU	Bushes - Steel - DU - Split - Unflanged
127.000 -0.000/-0.099	131.572 +0.000/-0.079	57.150 +0.25/-0.25			BP12700-13157-05715-SS6	Bushes - Stainless Steel and PTFE - Unflanged

 Stocked or Short Delivery

 Usually Available

 Long delivery or not in current production

ID	OD	B	DF	bf	Part Number	Type
127.000 x 131.572 mm (5.000 x 5.180 in.)						
127.000 -0.000/-0.099	131.572 +0.000/-0.079	63.500 +0.50/-0.50			BP12700-13157-06350-DP4	Bushes - Steel - DP4 - Split - Unflanged
127.000 -0.000/-0.099	131.572 +0.000/-0.079	63.500 +0.50/-0.50			BP12700-13157-06350-DU	Bushes - Steel - DU - Split - Unflanged
127.000 -0.000/-0.099	131.572 +0.000/-0.079	63.500 +0.25/-0.25			BP12700-13157-06350-SS6	Bushes - Stainless Steel and PTFE - Unflanged
127.000 -0.000/-0.099	131.572 +0.000/-0.079	76.200 +0.50/-0.50			BP12700-13157-07620-DP4	Bushes - Steel - DP4 - Split - Unflanged
127.000 -0.000/-0.099	131.572 +0.000/-0.079	76.200 +0.50/-0.50			BP12700-13157-07620-DU	Bushes - Steel - DU - Split - Unflanged
127.000 -0.000/-0.099	131.572 +0.000/-0.079	76.200 +0.25/-0.25			BP12700-13157-07620-SS6	Bushes - Stainless Steel and PTFE - Unflanged
127.000 -0.000/-0.099	131.572 +0.000/-0.079	88.900 +0.50/-0.50			BP12700-13157-08890-DP4	Bushes - Steel - DP4 - Split - Unflanged
127.000 -0.000/-0.099	131.572 +0.000/-0.079	88.900 +0.50/-0.50			BP12700-13157-08890-DU	Bushes - Steel - DU - Split - Unflanged
127.000 -0.000/-0.099	131.572 +0.000/-0.079	88.900 +0.25/-0.25			BP12700-13157-08890-SS6	Bushes - Stainless Steel and PTFE - Unflanged
127.000 -0.000/-0.099	131.572 +0.000/-0.079	95.250 +0.50/-0.50			BP12700-13157-09525-DP4	Bushes - Steel - DP4 - Split - Unflanged
127.000 -0.000/-0.099	131.572 +0.000/-0.079	95.250 +0.50/-0.50			BP12700-13157-09525-DU	Bushes - Steel - DU - Split - Unflanged
127.000 -0.000/-0.099	131.572 +0.000/-0.079	95.250 +0.25/-0.25			BP12700-13157-09525-SS6	Bushes - Stainless Steel and PTFE - Unflanged
127.000 -0.000/-0.099	131.572 +0.000/-0.079	101.600 +0.50/-0.50			BP12700-13157-10160-DP4	Bushes - Steel - DP4 - Split - Unflanged
127.000 -0.000/-0.099	131.572 +0.000/-0.079	101.600 +0.50/-0.50			BP12700-13157-10160-DU	Bushes - Steel - DU - Split - Unflanged
127.000 -0.000/-0.099	131.572 +0.000/-0.079	101.600 +0.25/-0.25			BP12700-13157-10160-SS6	Bushes - Stainless Steel and PTFE - Unflanged
127.000 -0.000/-0.099	131.572 +0.000/-0.079	114.300 +0.50/-0.50			BP12700-13157-11430-DP4	Bushes - Steel - DP4 - Split - Unflanged
127.000 -0.000/-0.099	131.572 +0.000/-0.079	114.300 +0.50/-0.50			BP12700-13157-11430-DU	Bushes - Steel - DU - Split - Unflanged
127.000 -0.000/-0.099	131.572 +0.000/-0.079	114.300 +0.25/-0.25			BP12700-13157-11430-SS6	Bushes - Stainless Steel and PTFE - Unflanged
127.000 -0.000/-0.099	131.572 +0.000/-0.079	120.650 +0.50/-0.50			BP12700-13157-12065-DP4	Bushes - Steel - DP4 - Split - Unflanged
127.000 -0.000/-0.099	131.572 +0.000/-0.079	120.650 +0.50/-0.50			BP12700-13157-12065-DU	Bushes - Steel - DU - Split - Unflanged
127.000 -0.000/-0.099	131.572 +0.000/-0.079	120.650 +0.25/-0.25			BP12700-13157-12065-SS6	Bushes - Stainless Steel and PTFE - Unflanged

130.000 x 135.000 mm (5.118 x 5.315 in.)						
130.000 -0.000/-0.063	135.000 +0.170/-0.000	50.000 +0.50/-0.50			BP13000-13500-05000-DX	Bushes - Steel - DX - Split - Unflanged
130.000 -0.000/-0.063	135.000 +0.170/-0.000	60.000 +0.00/-0.40			BP13000-13500-06000-SS6	Bushes - Stainless Steel and PTFE - Unflanged
130.000 -0.000/-0.063	135.000 +0.170/-0.000	60.000 +0.50/-0.50			BP13000-13500-06000-DP4	Bushes - Steel - DP4 - Split - Unflanged
130.000 -0.000/-0.063	135.000 +0.170/-0.000	60.000 +0.50/-0.50			BP13000-13500-06000-DU	Bushes - Steel - DU - Split - Unflanged
130.000 -0.000/-0.063	135.000 +0.170/-0.000	60.000 +0.50/-0.50			BP13000-13500-06000-DX	Bushes - Steel - DX - Split - Unflanged
130.000 -0.000/-0.063	135.000 +0.170/-0.000	80.000 +0.50/-0.50			BP13000-13500-08000-DP4	Bushes - Steel - DP4 - Split - Unflanged
130.000 -0.000/-0.063	135.000 +0.170/-0.000	80.000 +0.50/-0.50			BP13000-13500-08000-DU	Bushes - Steel - DU - Split - Unflanged
130.000 -0.000/-0.063	135.000 +0.170/-0.000	80.000 +0.00/-0.40			BP13000-13500-08000-SS6	Bushes - Stainless Steel and PTFE - Unflanged
130.000 -0.000/-0.063	135.000 +0.170/-0.000	80.000 +0.50/-0.50			BP13000-13500-08000-DX	Bushes - Steel - DX - Split - Unflanged
130.000 -0.000/-0.063	135.000 +0.170/-0.000	100.000 +0.00/-0.40			BP13000-13500-10000-SS6	Bushes - Stainless Steel and PTFE - Unflanged
130.000 -0.000/-0.063	135.000 +0.170/-0.000	100.000 +0.50/-0.50			BP13000-13500-10000-DP4	Bushes - Steel - DP4 - Split - Unflanged
130.000 -0.000/-0.063	135.000 +0.170/-0.000	100.000 +0.50/-0.50			BP13000-13500-10000-DU	Bushes - Steel - DU - Split - Unflanged
130.000 -0.000/-0.063	135.000 +0.170/-0.000	100.000 +0.50/-0.50			BP13000-13500-10000-DX	Bushes - Steel - DX - Split - Unflanged

133.350 x 137.922 mm (5.250 x 5.430 in.)						
133.350 -0.000/-0.064	137.922 +0.000/-0.043	50.800 +0.50/-0.50			BP13335-13792-05080-DU	Bushes - Steel - DU - Split - Unflanged
133.350 -0.000/-0.064	137.922 +0.000/-0.043	50.800 +0.25/-0.25			BP13335-13792-05080-SS6	Bushes - Stainless Steel and PTFE - Unflanged
133.350 -0.000/-0.064	137.922 +0.000/-0.043	50.800 +0.50/-0.50			BP13335-13792-05080-DP4	Bushes - Steel - DP4 - Split - Unflanged
133.350 -0.000/-0.064	137.922 +0.000/-0.043	57.150 +0.25/-0.25			BP13335-13792-05715-SS6	Bushes - Stainless Steel and PTFE - Unflanged

 Stocked or Short Delivery

 Usually Available

 Long delivery or not in current production

ID	OD	B	DF	bf	Part Number	Type
----	----	---	----	----	-------------	------

133.350 x 137.922 mm (5.250 x 5.430 in.)						
133.350 -0.000/-0.064	137.922 +0.000/-0.043	57.150 +0.50/-0.50			BP13335-13792-05715-DP4	Bushes - Steel - DP4 - Split - Unflanged
133.350 -0.000/-0.064	137.922 +0.000/-0.043	57.150 +0.50/-0.50			BP13335-13792-05715-DU	Bushes - Steel - DU - Split - Unflanged
133.350 -0.000/-0.064	137.922 +0.000/-0.043	63.500 +0.25/-0.25			BP13335-13792-06350-SS6	Bushes - Stainless Steel and PTFE - Unflanged
133.350 -0.000/-0.064	137.922 +0.000/-0.043	63.500 +0.50/-0.50			BP13335-13792-06350-DP4	Bushes - Steel - DP4 - Split - Unflanged
133.350 -0.000/-0.064	137.922 +0.000/-0.043	63.500 +0.50/-0.50			BP13335-13792-06350-DU	Bushes - Steel - DU - Split - Unflanged
133.350 -0.000/-0.064	137.922 +0.000/-0.043	76.200 +0.50/-0.50			BP13335-13792-07620-DP4	Bushes - Steel - DP4 - Split - Unflanged
133.350 -0.000/-0.064	137.922 +0.000/-0.043	76.200 +0.50/-0.50			BP13335-13792-07620-DU	Bushes - Steel - DU - Split - Unflanged
133.350 -0.000/-0.064	137.922 +0.000/-0.043	76.200 +0.25/-0.25			BP13335-13792-07620-SS6	Bushes - Stainless Steel and PTFE - Unflanged
133.350 -0.000/-0.064	137.922 +0.000/-0.043	88.900 +0.50/-0.50			BP13335-13792-08890-DP4	Bushes - Steel - DP4 - Split - Unflanged
133.350 -0.000/-0.064	137.922 +0.000/-0.043	88.900 +0.50/-0.50			BP13335-13792-08890-DU	Bushes - Steel - DU - Split - Unflanged
133.350 -0.000/-0.064	137.922 +0.000/-0.043	88.900 +0.25/-0.25			BP13335-13792-08890-SS6	Bushes - Stainless Steel and PTFE - Unflanged
133.350 -0.000/-0.064	137.922 +0.000/-0.043	95.250 +0.50/-0.50			BP13335-13792-09525-DP4	Bushes - Steel - DP4 - Split - Unflanged
133.350 -0.000/-0.064	137.922 +0.000/-0.043	95.250 +0.50/-0.50			BP13335-13792-09525-DU	Bushes - Steel - DU - Split - Unflanged
133.350 -0.000/-0.064	137.922 +0.000/-0.043	95.250 +0.25/-0.25			BP13335-13792-09525-SS6	Bushes - Stainless Steel and PTFE - Unflanged
133.350 -0.000/-0.064	137.922 +0.000/-0.043	101.600 +0.50/-0.50			BP13335-13792-10160-DP4	Bushes - Steel - DP4 - Split - Unflanged
133.350 -0.000/-0.064	137.922 +0.000/-0.043	101.600 +0.50/-0.50			BP13335-13792-10160-DU	Bushes - Steel - DU - Split - Unflanged
133.350 -0.000/-0.064	137.922 +0.000/-0.043	101.600 +0.25/-0.25			BP13335-13792-10160-SS6	Bushes - Stainless Steel and PTFE - Unflanged
133.350 -0.000/-0.064	137.922 +0.000/-0.043	114.300 +0.50/-0.50			BP13335-13792-11430-DP4	Bushes - Steel - DP4 - Split - Unflanged
133.350 -0.000/-0.064	137.922 +0.000/-0.043	114.300 +0.50/-0.50			BP13335-13792-11430-DU	Bushes - Steel - DU - Split - Unflanged
133.350 -0.000/-0.064	137.922 +0.000/-0.043	114.300 +0.25/-0.25			BP13335-13792-11430-SS6	Bushes - Stainless Steel and PTFE - Unflanged
133.350 -0.000/-0.064	137.922 +0.000/-0.043	120.650 +0.50/-0.50			BP13335-13792-12065-DP4	Bushes - Steel - DP4 - Split - Unflanged
133.350 -0.000/-0.064	137.922 +0.000/-0.043	120.650 +0.50/-0.50			BP13335-13792-12065-DU	Bushes - Steel - DU - Split - Unflanged
133.350 -0.000/-0.064	137.922 +0.000/-0.043	120.650 +0.25/-0.25			BP13335-13792-12065-SS6	Bushes - Stainless Steel and PTFE - Unflanged

135.000 x 140.000 mm (5.315 x 5.512 in.)						
135.000 -0.000/-0.064	140.000 +0.170/-0.000	60.000 +0.50/-0.50			BP13500-14000-06000-DU	Bushes - Steel - DU - Split - Unflanged
135.000 -0.000/-0.064	140.000 +0.170/-0.000	60.000 +0.50/-0.50			BP13500-14000-06000-DX	Bushes - Steel - DX - Split - Unflanged
135.000 -0.000/-0.064	140.000 +0.170/-0.000	80.000 +0.50/-0.50			BP13500-14000-08000-DU	Bushes - Steel - DU - Split - Unflanged
135.000 -0.000/-0.064	140.000 +0.170/-0.000	80.000 +0.50/-0.50			BP13500-14000-08000-DX	Bushes - Steel - DX - Split - Unflanged

139.700 x 144.272 mm (5.500 x 5.680 in.)						
139.700 -0.000/-0.064	144.272 +0.000/-0.043	50.800 +0.50/-0.50			BP13970-14427-05080-DU	Bushes - Steel - DU - Split - Unflanged
139.700 -0.000/-0.064	144.272 +0.000/-0.043	50.800 +0.25/-0.25			BP13970-14427-05080-SS6	Bushes - Stainless Steel and PTFE - Unflanged
139.700 -0.000/-0.064	144.272 +0.000/-0.043	50.800 +0.50/-0.50			BP13970-14427-05080-DP4	Bushes - Steel - DP4 - Split - Unflanged
139.700 -0.000/-0.064	144.272 +0.000/-0.043	57.150 +0.25/-0.25			BP13970-14427-05715-SS6	Bushes - Stainless Steel and PTFE - Unflanged
139.700 -0.000/-0.064	144.272 +0.000/-0.043	57.150 +0.50/-0.50			BP13970-14427-05715-DP4	Bushes - Steel - DP4 - Split - Unflanged
139.700 -0.000/-0.064	144.272 +0.000/-0.043	57.150 +0.50/-0.50			BP13970-14427-05715-DU	Bushes - Steel - DU - Split - Unflanged
139.700 -0.000/-0.064	144.272 +0.000/-0.043	63.500 +0.25/-0.25			BP13970-14427-06350-SS6	Bushes - Stainless Steel and PTFE - Unflanged
139.700 -0.000/-0.064	144.272 +0.000/-0.043	63.500 +0.50/-0.50			BP13970-14427-06350-DP4	Bushes - Steel - DP4 - Split - Unflanged
139.700 -0.000/-0.064	144.272 +0.000/-0.043	63.500 +0.50/-0.50			BP13970-14427-06350-DU	Bushes - Steel - DU - Split - Unflanged
139.700 -0.000/-0.064	144.272 +0.000/-0.043	76.200 +0.50/-0.50			BP13970-14427-07620-DP4	Bushes - Steel - DP4 - Split - Unflanged
139.700 -0.000/-0.064	144.272 +0.000/-0.043	76.200 +0.50/-0.50			BP13970-14427-07620-DU	Bushes - Steel - DU - Split - Unflanged

 Stocked or Short Delivery

 Usually Available

 Long delivery or not in current production

ID	OD	B	DF	bf	Part Number	Type
139.700 x 144.272 mm (5.500 x 5.680 in.)						
139.700 -0.000/-0.064	144.272 +0.000/-0.043	76.200 +0.25/-0.25			BP13970-14427-07620-SS6	Bushes - Stainless Steel and PTFE - Unflanged
139.700 -0.000/-0.064	144.272 +0.000/-0.043	88.900 +0.50/-0.50			BP13970-14427-08890-DP4	Bushes - Steel - DP4 - Split - Unflanged
139.700 -0.000/-0.064	144.272 +0.000/-0.043	88.900 +0.50/-0.50			BP13970-14427-08890-DU	Bushes - Steel - DU - Split - Unflanged
139.700 -0.000/-0.064	144.272 +0.000/-0.043	88.900 +0.25/-0.25			BP13970-14427-08890-SS6	Bushes - Stainless Steel and PTFE - Unflanged
139.700 -0.000/-0.064	144.272 +0.000/-0.043	95.250 +0.50/-0.50			BP13970-14427-09525-DP4	Bushes - Steel - DP4 - Split - Unflanged
139.700 -0.000/-0.064	144.272 +0.000/-0.043	95.250 +0.50/-0.50			BP13970-14427-09525-DU	Bushes - Steel - DU - Split - Unflanged
139.700 -0.000/-0.064	144.272 +0.000/-0.043	95.250 +0.25/-0.25			BP13970-14427-09525-SS6	Bushes - Stainless Steel and PTFE - Unflanged
139.700 -0.000/-0.064	144.272 +0.000/-0.043	101.600 +0.50/-0.50			BP13970-14427-10160-DP4	Bushes - Steel - DP4 - Split - Unflanged
139.700 -0.000/-0.064	144.272 +0.000/-0.043	101.600 +0.50/-0.50			BP13970-14427-10160-DU	Bushes - Steel - DU - Split - Unflanged
139.700 -0.000/-0.064	144.272 +0.000/-0.043	101.600 +0.25/-0.25			BP13970-14427-10160-SS6	Bushes - Stainless Steel and PTFE - Unflanged
139.700 -0.000/-0.064	144.272 +0.000/-0.043	114.300 +0.50/-0.50			BP13970-14427-11430-DP4	Bushes - Steel - DP4 - Split - Unflanged
139.700 -0.000/-0.064	144.272 +0.000/-0.043	114.300 +0.25/-0.25			BP13970-14427-11430-SS6	Bushes - Stainless Steel and PTFE - Unflanged
139.700 -0.000/-0.064	144.272 +0.000/-0.043	114.300 +0.50/-0.50			BP13970-14427-11430-DU	Bushes - Steel - DU - Split - Unflanged
139.700 -0.000/-0.064	144.272 +0.000/-0.043	120.650 +0.50/-0.50			BP13970-14427-12065-DP4	Bushes - Steel - DP4 - Split - Unflanged
139.700 -0.000/-0.064	144.272 +0.000/-0.043	120.650 +0.50/-0.50			BP13970-14427-12065-DU	Bushes - Steel - DU - Split - Unflanged
139.700 -0.000/-0.064	144.272 +0.000/-0.043	120.650 +0.25/-0.25			BP13970-14427-12065-SS6	Bushes - Stainless Steel and PTFE - Unflanged

140.000 x 145.000 mm (5.512 x 5.709 in.)						
140.000 -0.000/-0.063	145.000 +0.170/-0.000	50.000 +0.50/-0.50			BP14000-14500-05000-DX	Bushes - Steel - DX - Split - Unflanged
140.000 -0.000/-0.063	145.000 +0.170/-0.000	60.000 +0.50/-0.50			BP14000-14500-06000-DU	Bushes - Steel - DU - Split - Unflanged
140.000 -0.000/-0.063	145.000 +0.170/-0.000	60.000 +0.00/-0.40			BP14000-14500-06000-SS6	Bushes - Stainless Steel and PTFE - Unflanged
140.000 -0.000/-0.063	145.000 +0.170/-0.000	60.000 +0.50/-0.50			BP14000-14500-06000-DP4	Bushes - Steel - DP4 - Split - Unflanged
140.000 -0.000/-0.063	145.000 +0.170/-0.000	60.000 +0.50/-0.50			BP14000-14500-06000-DX	Bushes - Steel - DX - Split - Unflanged
140.000 -0.000/-0.063	145.000 +0.170/-0.000	80.000 +0.50/-0.50			BP14000-14500-08000-DP4	Bushes - Steel - DP4 - Split - Unflanged
140.000 -0.000/-0.063	145.000 +0.170/-0.000	80.000 +0.50/-0.50			BP14000-14500-08000-DU	Bushes - Steel - DU - Split - Unflanged
140.000 -0.000/-0.063	145.000 +0.170/-0.000	80.000 +0.00/-0.40			BP14000-14500-08000-SS6	Bushes - Stainless Steel and PTFE - Unflanged
140.000 -0.000/-0.063	145.000 +0.170/-0.000	80.000 +0.50/-0.50			BP14000-14500-08000-DX	Bushes - Steel - DX - Split - Unflanged
140.000 -0.000/-0.063	145.000 +0.170/-0.000	100.000 +0.50/-0.50			BP14000-14500-10000-DP4	Bushes - Steel - DP4 - Split - Unflanged
140.000 -0.000/-0.063	145.000 +0.170/-0.000	100.000 +0.00/-0.40			BP14000-14500-10000-SS6	Bushes - Stainless Steel and PTFE - Unflanged
140.000 -0.000/-0.063	145.000 +0.170/-0.000	100.000 +0.50/-0.50			BP14000-14500-10000-DU	Bushes - Steel - DU - Split - Unflanged
140.000 -0.000/-0.063	145.000 +0.170/-0.000	100.000 +0.50/-0.50			BP14000-14500-10000-DX	Bushes - Steel - DX - Split - Unflanged

146.050 x 150.622 mm (5.750 x 5.930 in.)						
146.050 -0.000/-0.064	150.622 +0.000/-0.043	50.800 +0.50/-0.50			BP14605-15062-05080-DP4	Bushes - Steel - DP4 - Split - Unflanged
146.050 -0.000/-0.064	150.622 +0.000/-0.043	50.800 +0.50/-0.50			BP14605-15062-05080-DU	Bushes - Steel - DU - Split - Unflanged
146.050 -0.000/-0.064	150.622 +0.000/-0.043	50.800 +0.25/-0.25			BP14605-15062-05080-SS6	Bushes - Stainless Steel and PTFE - Unflanged
146.050 -0.000/-0.064	150.622 +0.000/-0.043	57.150 +0.50/-0.50			BP14605-15062-05715-DP4	Bushes - Steel - DP4 - Split - Unflanged
146.050 -0.000/-0.064	150.622 +0.000/-0.043	57.150 +0.50/-0.50			BP14605-15062-05715-DU	Bushes - Steel - DU - Split - Unflanged
146.050 -0.000/-0.064	150.622 +0.000/-0.043	57.150 +0.25/-0.25			BP14605-15062-05715-SS6	Bushes - Stainless Steel and PTFE - Unflanged
146.050 -0.000/-0.064	150.622 +0.000/-0.043	63.500 +0.50/-0.50			BP14605-15062-06350-DP4	Bushes - Steel - DP4 - Split - Unflanged
146.050 -0.000/-0.064	150.622 +0.000/-0.043	63.500 +0.50/-0.50			BP14605-15062-06350-DU	Bushes - Steel - DU - Split - Unflanged
146.050 -0.000/-0.064	150.622 +0.000/-0.043	63.500 +0.25/-0.25			BP14605-15062-06350-SS6	Bushes - Stainless Steel and PTFE - Unflanged

 Stocked or Short Delivery

 Usually Available

 Long delivery or not in current production

ID	OD	B	DF	bf	Part Number	Type
146.050 x 150.622 mm (5.750 x 5.930 in.)						
146.050 -0.000/-0.064	150.622 +0.000/-0.043	76.200 +0.50/-0.50			BP14605-15062-07620-DP4	Bushes - Steel - DP4 - Split - Unflanged
146.050 -0.000/-0.064	150.622 +0.000/-0.043	76.200 +0.50/-0.50			BP14605-15062-07620-DU	Bushes - Steel - DU - Split - Unflanged
146.050 -0.000/-0.064	150.622 +0.000/-0.043	76.200 +0.25/-0.25			BP14605-15062-07620-SS6	Bushes - Stainless Steel and PTFE - Unflanged
146.050 -0.000/-0.064	150.622 +0.000/-0.043	88.900 +0.50/-0.50			BP14605-15062-08890-DP4	Bushes - Steel - DP4 - Split - Unflanged
146.050 -0.000/-0.064	150.622 +0.000/-0.043	88.900 +0.50/-0.50			BP14605-15062-08890-DU	Bushes - Steel - DU - Split - Unflanged
146.050 -0.000/-0.064	150.622 +0.000/-0.043	88.900 +0.25/-0.25			BP14605-15062-08890-SS6	Bushes - Stainless Steel and PTFE - Unflanged
146.050 -0.000/-0.064	150.622 +0.000/-0.043	95.250 +0.50/-0.50			BP14605-15062-09525-DP4	Bushes - Steel - DP4 - Split - Unflanged
146.050 -0.000/-0.064	150.622 +0.000/-0.043	95.250 +0.50/-0.50			BP14605-15062-09525-DU	Bushes - Steel - DU - Split - Unflanged
146.050 -0.000/-0.064	150.622 +0.000/-0.043	95.250 +0.25/-0.25			BP14605-15062-09525-SS6	Bushes - Stainless Steel and PTFE - Unflanged
146.050 -0.000/-0.064	150.622 +0.000/-0.043	101.600 +0.25/-0.25			BP14605-15062-10160-SS6	Bushes - Stainless Steel and PTFE - Unflanged
146.050 -0.000/-0.064	150.622 +0.000/-0.043	101.600 +0.50/-0.50			BP14605-15062-10160-DP4	Bushes - Steel - DP4 - Split - Unflanged
146.050 -0.000/-0.064	150.622 +0.000/-0.043	101.600 +0.50/-0.50			BP14605-15062-10160-DU	Bushes - Steel - DU - Split - Unflanged
146.050 -0.000/-0.064	150.622 +0.000/-0.043	114.300 +0.25/-0.25			BP14605-15062-11430-SS6	Bushes - Stainless Steel and PTFE - Unflanged
146.050 -0.000/-0.064	150.622 +0.000/-0.043	114.300 +0.50/-0.50			BP14605-15062-11430-DP4	Bushes - Steel - DP4 - Split - Unflanged
146.050 -0.000/-0.064	150.622 +0.000/-0.043	114.300 +0.50/-0.50			BP14605-15062-11430-DU	Bushes - Steel - DU - Split - Unflanged
146.050 -0.000/-0.064	150.622 +0.000/-0.043	120.650 +0.50/-0.50			BP14605-15062-12065-DP4	Bushes - Steel - DP4 - Split - Unflanged
146.050 -0.000/-0.064	150.622 +0.000/-0.043	120.650 +0.50/-0.50			BP14605-15062-12065-DU	Bushes - Steel - DU - Split - Unflanged
146.050 -0.000/-0.064	150.622 +0.000/-0.043	120.650 +0.25/-0.25			BP14605-15062-12065-SS6	Bushes - Stainless Steel and PTFE - Unflanged

150.000 x 155.000 mm (5.906 x 6.102 in.)						
150.000 -0.000/-0.063	155.000 +0.170/-0.000	50.000 +0.50/-0.50			BP15000-15500-05000-DX	Bushes - Steel - DX - Split - Unflanged
150.000 -0.000/-0.063	155.000 +0.170/-0.000	60.000 +0.00/-0.40			BP15000-15500-06000-SS6	Bushes - Stainless Steel and PTFE - Unflanged
150.000 -0.000/-0.063	155.000 +0.170/-0.000	60.000 +0.50/-0.50			BP15000-15500-06000-DP4	Bushes - Steel - DP4 - Split - Unflanged
150.000 -0.000/-0.063	155.000 +0.170/-0.000	60.000 +0.50/-0.50			BP15000-15500-06000-DU	Bushes - Steel - DU - Split - Unflanged
150.000 -0.000/-0.063	155.000 +0.170/-0.000	60.000 +0.50/-0.50			BP15000-15500-06000-DX	Bushes - Steel - DX - Split - Unflanged
150.000 -0.000/-0.063	155.000 +0.170/-0.000	80.000 +0.50/-0.50			BP15000-15500-08000-DP4	Bushes - Steel - DP4 - Split - Unflanged
150.000 -0.000/-0.063	155.000 +0.170/-0.000	80.000 +0.50/-0.50			BP15000-15500-08000-DU	Bushes - Steel - DU - Split - Unflanged
150.000 -0.000/-0.063	155.000 +0.170/-0.000	80.000 +0.00/-0.40			BP15000-15500-08000-SS6	Bushes - Stainless Steel and PTFE - Unflanged
150.000 -0.000/-0.063	155.000 +0.170/-0.000	80.000 +0.50/-0.50			BP15000-15500-08000-DX	Bushes - Steel - DX - Split - Unflanged
150.000 -0.000/-0.063	155.000 +0.170/-0.000	100.000 +0.50/-0.50			BP15000-15500-10000-DP4	Bushes - Steel - DP4 - Split - Unflanged
150.000 -0.000/-0.063	155.000 +0.170/-0.000	100.000 +0.50/-0.50			BP15000-15500-10000-DU	Bushes - Steel - DU - Split - Unflanged
150.000 -0.000/-0.063	155.000 +0.170/-0.000	100.000 +0.00/-0.40			BP15000-15500-10000-SS6	Bushes - Stainless Steel and PTFE - Unflanged
150.000 -0.000/-0.063	155.000 +0.170/-0.000	100.000 +0.50/-0.50			BP15000-15500-10000-DX	Bushes - Steel - DX - Split - Unflanged

152.400 x 157.150 mm (6.000 x 6.187 in.)						
152.400 -0.000/-0.064	157.150 +0.000/-0.043	50.800 +0.50/-0.50			BP15240-15715-05080-DP4	Bushes - Steel - DP4 - Split - Unflanged
152.400 -0.000/-0.064	157.150 +0.000/-0.043	50.800 +0.50/-0.50			BP15240-15715-05080-DU	Bushes - Steel - DU - Split - Unflanged
152.400 -0.000/-0.064	157.150 +0.000/-0.043	50.800 +0.25/-0.25			BP15240-15715-05080-SS6	Bushes - Stainless Steel and PTFE - Unflanged
152.400 -0.000/-0.064	157.150 +0.000/-0.043	57.150 +0.50/-0.50			BP15240-15715-05715-DP4	Bushes - Steel - DP4 - Split - Unflanged
152.400 -0.000/-0.064	157.150 +0.000/-0.043	57.150 +0.25/-0.25			BP15240-15715-05715-SS6	Bushes - Stainless Steel and PTFE - Unflanged
152.400 -0.000/-0.064	157.150 +0.000/-0.043	57.150 +0.50/-0.50			BP15240-15715-05715-DU	Bushes - Steel - DU - Split - Unflanged
152.400 -0.000/-0.064	157.150 +0.000/-0.043	63.500 +0.50/-0.50			BP15240-15715-06350-DP4	Bushes - Steel - DP4 - Split - Unflanged

 Stocked or Short Delivery

 Usually Available

 Long delivery or not in current production

ID	OD	B	DF	bf	Part Number	Type
----	----	---	----	----	-------------	------

152.400 x 157.150 mm (6.000 x 6.187 in.)						
152.400 -0.000/-0.064	157.150 +0.000/-0.043	63.500 +0.50/-0.50			BP15240-15715-06350-DU	Bushes - Steel - DU - Split - Unflanged
152.400 -0.000/-0.064	157.150 +0.000/-0.043	63.500 +0.25/-0.25			BP15240-15715-06350-SS6	Bushes - Stainless Steel and PTFE - Unflanged
152.400 -0.000/-0.064	157.150 +0.000/-0.043	76.200 +0.50/-0.50			BP15240-15715-07620-DP4	Bushes - Steel - DP4 - Split - Unflanged
152.400 -0.000/-0.064	157.150 +0.000/-0.043	76.200 +0.50/-0.50			BP15240-15715-07620-DU	Bushes - Steel - DU - Split - Unflanged
152.400 -0.000/-0.064	157.150 +0.000/-0.043	76.200 +0.25/-0.25			BP15240-15715-07620-SS6	Bushes - Stainless Steel and PTFE - Unflanged
152.400 -0.000/-0.064	157.150 +0.000/-0.043	88.900 +0.50/-0.50			BP15240-15715-08890-DP4	Bushes - Steel - DP4 - Split - Unflanged
152.400 -0.000/-0.064	157.150 +0.000/-0.043	88.900 +0.50/-0.50			BP15240-15715-08890-DU	Bushes - Steel - DU - Split - Unflanged
152.400 -0.000/-0.064	157.150 +0.000/-0.043	88.900 +0.25/-0.25			BP15240-15715-08890-SS6	Bushes - Stainless Steel and PTFE - Unflanged
152.400 -0.000/-0.064	157.150 +0.000/-0.043	95.250 +0.50/-0.50			BP15240-15715-09525-DP4	Bushes - Steel - DP4 - Split - Unflanged
152.400 -0.000/-0.064	157.150 +0.000/-0.043	95.250 +0.50/-0.50			BP15240-15715-09525-DU	Bushes - Steel - DU - Split - Unflanged
152.400 -0.000/-0.064	157.150 +0.000/-0.043	95.250 +0.25/-0.25			BP15240-15715-09525-SS6	Bushes - Stainless Steel and PTFE - Unflanged
152.400 -0.000/-0.064	157.150 +0.000/-0.043	101.600 +0.50/-0.50			BP15240-15715-10160-DP4	Bushes - Steel - DP4 - Split - Unflanged
152.400 -0.000/-0.064	157.150 +0.000/-0.043	101.600 +0.50/-0.50			BP15240-15715-10160-DU	Bushes - Steel - DU - Split - Unflanged
152.400 -0.000/-0.064	157.150 +0.000/-0.043	101.600 +0.25/-0.25			BP15240-15715-10160-SS6	Bushes - Stainless Steel and PTFE - Unflanged
152.400 -0.000/-0.064	157.150 +0.000/-0.043	114.300 +0.50/-0.50			BP15240-15715-11430-DP4	Bushes - Steel - DP4 - Split - Unflanged
152.400 -0.000/-0.064	157.150 +0.000/-0.043	114.300 +0.50/-0.50			BP15240-15715-11430-DU	Bushes - Steel - DU - Split - Unflanged
152.400 -0.000/-0.064	157.150 +0.000/-0.043	114.300 +0.25/-0.25			BP15240-15715-11430-SS6	Bushes - Stainless Steel and PTFE - Unflanged
152.400 -0.000/-0.064	157.150 +0.000/-0.043	120.650 +0.50/-0.50			BP15240-15715-12065-DP4	Bushes - Steel - DP4 - Split - Unflanged
152.400 -0.000/-0.064	157.150 +0.000/-0.043	120.650 +0.50/-0.50			BP15240-15715-12065-DU	Bushes - Steel - DU - Split - Unflanged
152.400 -0.000/-0.064	157.150 +0.000/-0.043	120.650 +0.25/-0.25			BP15240-15715-12065-SS6	Bushes - Stainless Steel and PTFE - Unflanged

158.750 x 163.500 mm (6.250 x 6.437 in.)						
158.750 -0.000/-0.064	163.513 +0.000/-0.043	50.800 +0.50/-0.50			BP15875-16350-05080-DP4	Bushes - Steel - DP4 - Split - Unflanged
158.750 -0.000/-0.064	163.513 +0.000/-0.043	50.800 +0.50/-0.50			BP15875-16350-05080-DU	Bushes - Steel - DU - Split - Unflanged
158.750 -0.000/-0.064	163.513 +0.000/-0.043	50.800 +0.25/-0.25			BP15875-16350-05080-SS6	Bushes - Stainless Steel and PTFE - Unflanged
158.750 -0.000/-0.064	163.513 +0.000/-0.043	57.150 +0.50/-0.50			BP15875-16350-05715-DP4	Bushes - Steel - DP4 - Split - Unflanged
158.750 -0.000/-0.064	163.513 +0.000/-0.043	57.150 +0.50/-0.50			BP15875-16350-05715-DU	Bushes - Steel - DU - Split - Unflanged
158.750 -0.000/-0.064	163.513 +0.000/-0.043	57.150 +0.25/-0.25			BP15875-16350-05715-SS6	Bushes - Stainless Steel and PTFE - Unflanged
158.750 -0.000/-0.064	163.513 +0.000/-0.043	63.500 +0.50/-0.50			BP15875-16350-06350-DP4	Bushes - Steel - DP4 - Split - Unflanged
158.750 -0.000/-0.064	163.513 +0.000/-0.043	63.500 +0.25/-0.25			BP15875-16350-06350-SS6	Bushes - Stainless Steel and PTFE - Unflanged
158.750 -0.000/-0.064	163.513 +0.000/-0.043	63.500 +0.50/-0.50			BP15875-16350-06350-DU	Bushes - Steel - DU - Split - Unflanged
158.750 -0.000/-0.064	163.513 +0.000/-0.043	76.200 +0.50/-0.50			BP15875-16350-07620-DP4	Bushes - Steel - DP4 - Split - Unflanged
158.750 -0.000/-0.064	163.513 +0.000/-0.043	76.200 +0.50/-0.50			BP15875-16350-07620-DU	Bushes - Steel - DU - Split - Unflanged
158.750 -0.000/-0.064	163.513 +0.000/-0.043	76.200 +0.25/-0.25			BP15875-16350-07620-SS6	Bushes - Stainless Steel and PTFE - Unflanged
158.750 -0.000/-0.064	163.513 +0.000/-0.043	88.900 +0.50/-0.50			BP15875-16350-08890-DP4	Bushes - Steel - DP4 - Split - Unflanged
158.750 -0.000/-0.064	163.513 +0.000/-0.043	88.900 +0.50/-0.50			BP15875-16350-08890-DU	Bushes - Steel - DU - Split - Unflanged
158.750 -0.000/-0.064	163.513 +0.000/-0.043	88.900 +0.25/-0.25			BP15875-16350-08890-SS6	Bushes - Stainless Steel and PTFE - Unflanged
158.750 -0.000/-0.064	163.513 +0.000/-0.043	95.250 +0.50/-0.50			BP15875-16350-09525-DP4	Bushes - Steel - DP4 - Split - Unflanged
158.750 -0.000/-0.064	163.513 +0.000/-0.043	95.250 +0.50/-0.50			BP15875-16350-09525-DU	Bushes - Steel - DU - Split - Unflanged
158.750 -0.000/-0.064	163.513 +0.000/-0.043	95.250 +0.25/-0.25			BP15875-16350-09525-SS6	Bushes - Stainless Steel and PTFE - Unflanged
158.750 -0.000/-0.064	163.513 +0.000/-0.043	101.600 +0.50/-0.50			BP15875-16350-10160-DP4	Bushes - Steel - DP4 - Split - Unflanged
158.750 -0.000/-0.064	163.513 +0.000/-0.043	101.600 +0.50/-0.50			BP15875-16350-10160-DU	Bushes - Steel - DU - Split - Unflanged

 Stocked or Short Delivery

 Usually Available

 Long delivery or not in current production

ID	OD	B	DF	bf	Part Number	Type
158.750 x 163.500 mm (6.250 x 6.437 in.)						
158.750 -0.000/-0.064	163.513 +0.000/-0.043	101.600 +0.25/-0.25			BP15875-16350-10160-SS6	Bushes - Stainless Steel and PTFE - Unflanged
158.750 -0.000/-0.064	163.513 +0.000/-0.043	114.300 +0.50/-0.50			BP15875-16350-11430-DP4	Bushes - Steel - DP4 - Split - Unflanged
158.750 -0.000/-0.064	163.513 +0.000/-0.043	114.300 +0.25/-0.25			BP15875-16350-11430-SS6	Bushes - Stainless Steel and PTFE - Unflanged
158.750 -0.000/-0.064	163.513 +0.000/-0.043	114.300 +0.50/-0.50			BP15875-16350-11430-DU	Bushes - Steel - DU - Split - Unflanged
158.750 -0.000/-0.064	163.513 +0.000/-0.043	120.650 +0.50/-0.50			BP15875-16350-12065-DP4	Bushes - Steel - DP4 - Split - Unflanged
158.750 -0.000/-0.064	163.513 +0.000/-0.043	120.650 +0.50/-0.50			BP15875-16350-12065-DU	Bushes - Steel - DU - Split - Unflanged
158.750 -0.000/-0.064	163.513 +0.000/-0.043	120.650 +0.25/-0.25			BP15875-16350-12065-SS6	Bushes - Stainless Steel and PTFE - Unflanged

160.000 x 165.000 mm (6.299 x 6.496 in.)						
160.000 -0.000/-0.063	165.000 +0.170/-0.000	50.000 +0.50/-0.50			BP16000-16500-05000-DX	Bushes - Steel - DX - Split - Unflanged
160.000 -0.000/-0.063	165.000 +0.170/-0.000	60.000 +0.50/-0.50			BP16000-16500-06000-DU	Bushes - Steel - DU - Split - Unflanged
160.000 -0.000/-0.063	165.000 +0.170/-0.000	60.000 +0.00/-0.40			BP16000-16500-06000-SS6	Bushes - Stainless Steel and PTFE - Unflanged
160.000 -0.000/-0.063	165.000 +0.170/-0.000	60.000 +0.50/-0.50			BP16000-16500-06000-DP4	Bushes - Steel - DP4 - Split - Unflanged
160.000 -0.000/-0.063	165.000 +0.170/-0.000	60.000 +0.50/-0.50			BP16000-16500-06000-DX	Bushes - Steel - DX - Split - Unflanged
160.000 -0.000/-0.063	165.000 +0.170/-0.000	80.000 +0.50/-0.50			BP16000-16500-08000-DP4	Bushes - Steel - DP4 - Split - Unflanged
160.000 -0.000/-0.063	165.000 +0.170/-0.000	80.000 +0.50/-0.50			BP16000-16500-08000-DU	Bushes - Steel - DU - Split - Unflanged
160.000 -0.000/-0.063	165.000 +0.170/-0.000	80.000 +0.00/-0.40			BP16000-16500-08000-SS6	Bushes - Stainless Steel and PTFE - Unflanged
160.000 -0.000/-0.063	165.000 +0.170/-0.000	80.000 +0.50/-0.50			BP16000-16500-08000-DX	Bushes - Steel - DX - Split - Unflanged
160.000 -0.000/-0.063	165.000 +0.170/-0.000	100.000 +0.00/-0.40			BP16000-16500-10000-SS6	Bushes - Stainless Steel and PTFE - Unflanged
160.000 -0.000/-0.063	165.000 +0.170/-0.000	100.000 +0.50/-0.50			BP16000-16500-10000-DU	Bushes - Steel - DU - Split - Unflanged
160.000 -0.000/-0.063	165.000 +0.170/-0.000	100.000 +0.50/-0.50			BP16000-16500-10000-DP4	Bushes - Steel - DP4 - Split - Unflanged
160.000 -0.000/-0.063	165.000 +0.170/-0.000	100.000 +0.50/-0.50			BP16000-16500-10000-DX	Bushes - Steel - DX - Split - Unflanged
160.000 -0.000/-0.063	165.000 +0.170/-0.000	115.000 +0.50/-0.50			BP16000-16500-11500-DP4	Bushes - Steel - DP4 - Split - Unflanged
160.000 -0.000/-0.063	165.000 +0.170/-0.000	115.000 +0.50/-0.50			BP16000-16500-11500-DU	Bushes - Steel - DU - Split - Unflanged
160.000 -0.000/-0.063	165.000 +0.170/-0.000	115.000 +0.00/-0.40			BP16000-16500-11500-SS6	Bushes - Stainless Steel and PTFE - Unflanged

165.100 x 169.672 mm (6.500 x 6.680 in.)						
165.100 -0.000/-0.064	169.672 +0.000/-0.043	50.800 +0.50/-0.50			BP16510-16967-05080-DP4	Bushes - Steel - DP4 - Split - Unflanged
165.100 -0.000/-0.064	169.672 +0.000/-0.043	50.800 +0.50/-0.50			BP16510-16967-05080-DU	Bushes - Steel - DU - Split - Unflanged
165.100 -0.000/-0.064	169.672 +0.000/-0.043	50.800 +0.25/-0.25			BP16510-16967-05080-SS6	Bushes - Stainless Steel and PTFE - Unflanged
165.100 -0.000/-0.064	169.672 +0.000/-0.043	57.150 +0.50/-0.50			BP16510-16967-05715-DP4	Bushes - Steel - DP4 - Split - Unflanged
165.100 -0.000/-0.064	169.672 +0.000/-0.043	57.150 +0.50/-0.50			BP16510-16967-05715-DU	Bushes - Steel - DU - Split - Unflanged
165.100 -0.000/-0.064	169.672 +0.000/-0.043	57.150 +0.25/-0.25			BP16510-16967-05715-SS6	Bushes - Stainless Steel and PTFE - Unflanged
165.100 -0.000/-0.064	169.672 +0.000/-0.043	63.500 +0.50/-0.50			BP16510-16967-06350-DP4	Bushes - Steel - DP4 - Split - Unflanged
165.100 -0.000/-0.064	169.672 +0.000/-0.043	63.500 +0.50/-0.50			BP16510-16967-06350-DU	Bushes - Steel - DU - Split - Unflanged
165.100 -0.000/-0.064	169.672 +0.000/-0.043	63.500 +0.25/-0.25			BP16510-16967-06350-SS6	Bushes - Stainless Steel and PTFE - Unflanged
165.100 -0.000/-0.064	169.672 +0.000/-0.043	76.200 +0.50/-0.50			BP16510-16967-07620-DP4	Bushes - Steel - DP4 - Split - Unflanged
165.100 -0.000/-0.064	169.672 +0.000/-0.043	76.200 +0.50/-0.50			BP16510-16967-07620-DU	Bushes - Steel - DU - Split - Unflanged
165.100 -0.000/-0.064	169.672 +0.000/-0.043	76.200 +0.25/-0.25			BP16510-16967-07620-SS6	Bushes - Stainless Steel and PTFE - Unflanged
165.100 -0.000/-0.064	169.672 +0.000/-0.043	88.900 +0.50/-0.50			BP16510-16967-08890-DP4	Bushes - Steel - DP4 - Split - Unflanged
165.100 -0.000/-0.064	169.672 +0.000/-0.043	88.900 +0.50/-0.50			BP16510-16967-08890-DU	Bushes - Steel - DU - Split - Unflanged
165.100 -0.000/-0.064	169.672 +0.000/-0.043	88.900 +0.25/-0.25			BP16510-16967-08890-SS6	Bushes - Stainless Steel and PTFE - Unflanged

 Stocked or Short Delivery

 Usually Available

 Long delivery or not in current production

ID	OD	B	DF	bf	Part Number	Type
165.100 x 169.672 mm (6.500 x 6.680 in.)						
165.100 -0.000/-0.064	169.672 +0.000/-0.043	95.250 +0.25/-0.25			BP16510-16967-09525-SS6	Bushes - Stainless Steel and PTFE - Unflanged
165.100 -0.000/-0.064	169.672 +0.000/-0.043	95.250 +0.50/-0.50			BP16510-16967-09525-DP4	Bushes - Steel - DP4 - Split - Unflanged
165.100 -0.000/-0.064	169.672 +0.000/-0.043	95.250 +0.50/-0.50			BP16510-16967-09525-DU	Bushes - Steel - DU - Split - Unflanged
165.100 -0.000/-0.064	169.672 +0.000/-0.043	101.600 +0.25/-0.25			BP16510-16967-10160-SS6	Bushes - Stainless Steel and PTFE - Unflanged
165.100 -0.000/-0.064	169.672 +0.000/-0.043	101.600 +0.50/-0.50			BP16510-16967-10160-DP4	Bushes - Steel - DP4 - Split - Unflanged
165.100 -0.000/-0.064	169.672 +0.000/-0.043	101.600 +0.50/-0.50			BP16510-16967-10160-DU	Bushes - Steel - DU - Split - Unflanged
165.100 -0.000/-0.064	169.672 +0.000/-0.043	114.300 +0.50/-0.50			BP16510-16967-11430-DP4	Bushes - Steel - DP4 - Split - Unflanged
165.100 -0.000/-0.064	169.672 +0.000/-0.043	114.300 +0.50/-0.50			BP16510-16967-11430-DU	Bushes - Steel - DU - Split - Unflanged
165.100 -0.000/-0.064	169.672 +0.000/-0.043	114.300 +0.25/-0.25			BP16510-16967-11430-SS6	Bushes - Stainless Steel and PTFE - Unflanged
165.100 -0.000/-0.064	169.672 +0.000/-0.043	120.650 +0.25/-0.25			BP16510-16967-12065-SS6	Bushes - Stainless Steel and PTFE - Unflanged
165.100 -0.000/-0.064	169.672 +0.000/-0.043	120.650 +0.50/-0.50			BP16510-16967-12065-DU	Bushes - Steel - DU - Split - Unflanged
165.100 -0.000/-0.064	169.672 +0.000/-0.043	120.650 +0.50/-0.50			BP16510-16967-12065-DP4	Bushes - Steel - DP4 - Split - Unflanged

170.000 x 175.000 mm (6.693 x 6.890 in.)						
170.000 -0.000/-0.064	175.000 +0.170/-0.000	50.000 +0.50/-0.50			BP17000-17500-05000-DX	Bushes - Steel - DX - Split - Unflanged
170.000 -0.000/-0.064	175.000 +0.170/-0.000	60.000 +0.50/-0.50			BP17000-17500-06000-DX	Bushes - Steel - DX - Split - Unflanged
170.000 -0.000/-0.064	175.000 +0.170/-0.000	80.000 +0.50/-0.50			BP17000-17500-08000-DX	Bushes - Steel - DX - Split - Unflanged
170.000 -0.000/-0.064	175.000 +0.170/-0.000	100.000 +0.50/-0.50			BP17000-17500-10000-DX	Bushes - Steel - DX - Split - Unflanged

171.450 x 176.022 mm (6.750 x 6.930 in.)						
171.450 -0.000/-0.064	176.022 +0.000/-0.043	50.800 +0.50/-0.50			BP17145-17602-05080-DP4	Bushes - Steel - DP4 - Split - Unflanged
171.450 -0.000/-0.064	176.022 +0.000/-0.043	50.800 +0.50/-0.50			BP17145-17602-05080-DU	Bushes - Steel - DU - Split - Unflanged
171.450 -0.000/-0.064	176.022 +0.000/-0.043	50.800 +0.25/-0.25			BP17145-17602-05080-SS6	Bushes - Stainless Steel and PTFE - Unflanged
171.450 -0.000/-0.064	176.022 +0.000/-0.043	57.150 +0.50/-0.50			BP17145-17602-05715-DP4	Bushes - Steel - DP4 - Split - Unflanged
171.450 -0.000/-0.064	176.022 +0.000/-0.043	57.150 +0.50/-0.50			BP17145-17602-05715-DU	Bushes - Steel - DU - Split - Unflanged
171.450 -0.000/-0.064	176.022 +0.000/-0.043	57.150 +0.25/-0.25			BP17145-17602-05715-SS6	Bushes - Stainless Steel and PTFE - Unflanged
171.450 -0.000/-0.064	176.022 +0.000/-0.043	63.500 +0.50/-0.50			BP17145-17602-06350-DP4	Bushes - Steel - DP4 - Split - Unflanged
171.450 -0.000/-0.064	176.022 +0.000/-0.043	63.500 +0.50/-0.50			BP17145-17602-06350-DU	Bushes - Steel - DU - Split - Unflanged
171.450 -0.000/-0.064	176.022 +0.000/-0.043	63.500 +0.25/-0.25			BP17145-17602-06350-SS6	Bushes - Stainless Steel and PTFE - Unflanged
171.450 -0.000/-0.064	176.022 +0.000/-0.043	76.200 +0.50/-0.50			BP17145-17602-07620-DP4	Bushes - Steel - DP4 - Split - Unflanged
171.450 -0.000/-0.064	176.022 +0.000/-0.043	76.200 +0.50/-0.50			BP17145-17602-07620-DU	Bushes - Steel - DU - Split - Unflanged
171.450 -0.000/-0.064	176.022 +0.000/-0.043	76.200 +0.25/-0.25			BP17145-17602-07620-SS6	Bushes - Stainless Steel and PTFE - Unflanged
171.450 -0.000/-0.064	176.022 +0.000/-0.043	88.900 +0.50/-0.50			BP17145-17602-08890-DP4	Bushes - Steel - DP4 - Split - Unflanged
171.450 -0.000/-0.064	176.022 +0.000/-0.043	88.900 +0.50/-0.50			BP17145-17602-08890-DU	Bushes - Steel - DU - Split - Unflanged
171.450 -0.000/-0.064	176.022 +0.000/-0.043	88.900 +0.25/-0.25			BP17145-17602-08890-SS6	Bushes - Stainless Steel and PTFE - Unflanged
171.450 -0.000/-0.064	176.022 +0.000/-0.043	95.250 +0.25/-0.25			BP17145-17602-09525-SS6	Bushes - Stainless Steel and PTFE - Unflanged
171.450 -0.000/-0.064	176.022 +0.000/-0.043	95.250 +0.50/-0.50			BP17145-17602-09525-DP4	Bushes - Steel - DP4 - Split - Unflanged
171.450 -0.000/-0.064	176.022 +0.000/-0.043	95.250 +0.50/-0.50			BP17145-17602-09525-DU	Bushes - Steel - DU - Split - Unflanged
171.450 -0.000/-0.064	176.022 +0.000/-0.043	101.600 +0.25/-0.25			BP17145-17602-10160-SS6	Bushes - Stainless Steel and PTFE - Unflanged
171.450 -0.000/-0.064	176.022 +0.000/-0.043	101.600 +0.50/-0.50			BP17145-17602-10160-DP4	Bushes - Steel - DP4 - Split - Unflanged
171.450 -0.000/-0.064	176.022 +0.000/-0.043	101.600 +0.50/-0.50			BP17145-17602-10160-DU	Bushes - Steel - DU - Split - Unflanged
171.450 -0.000/-0.064	176.022 +0.000/-0.043	114.300 +0.50/-0.50			BP17145-17602-11430-DP4	Bushes - Steel - DP4 - Split - Unflanged

 Stocked or Short Delivery

 Usually Available

 Long delivery or not in current production

ID	OD	B	DF	bf	Part Number	Type
171.450 x 176.022 mm (6.750 x 6.930 in.)						
171.450 -0.000/-0.064	176.022 +0.000/-0.043	114.300 +0.50/-0.50			BP17145-17602-11430-DU	Bushes - Steel - DU - Split - Unflanged
171.450 -0.000/-0.064	176.022 +0.000/-0.043	114.300 +0.25/-0.25			BP17145-17602-11430-SS6	Bushes - Stainless Steel and PTFE - Unflanged
171.450 -0.000/-0.064	176.022 +0.000/-0.043	120.650 +0.50/-0.50			BP17145-17602-12065-DU	Bushes - Steel - DU - Split - Unflanged
171.450 -0.000/-0.064	176.022 +0.000/-0.043	120.650 +0.25/-0.25			BP17145-17602-12065-SS6	Bushes - Stainless Steel and PTFE - Unflanged
171.450 -0.000/-0.064	176.022 +0.000/-0.043	120.650 +0.50/-0.50			BP17145-17602-12065-DP4	Bushes - Steel - DP4 - Split - Unflanged
177.800 x 182.372 mm (7.000 x 7.180 in.)						
177.800 -0.000/-0.180	182.372 +0.000/-0.160	50.800 +0.50/-0.50			BP17780-18237-05080-DP4	Bushes - Steel - DP4 - Split - Unflanged
177.800 -0.000/-0.180	182.372 +0.000/-0.160	50.800 +0.50/-0.50			BP17780-18237-05080-DU	Bushes - Steel - DU - Split - Unflanged
177.800 -0.000/-0.180	182.372 +0.000/-0.160	50.800 +0.25/-0.25			BP17780-18237-05080-SS6	Bushes - Stainless Steel and PTFE - Unflanged
177.800 -0.000/-0.180	182.372 +0.000/-0.160	57.150 +0.50/-0.50			BP17780-18237-05715-DP4	Bushes - Steel - DP4 - Split - Unflanged
177.800 -0.000/-0.180	182.372 +0.000/-0.160	57.150 +0.50/-0.50			BP17780-18237-05715-DU	Bushes - Steel - DU - Split - Unflanged
177.800 -0.000/-0.180	182.372 +0.000/-0.160	57.150 +0.25/-0.25			BP17780-18237-05715-SS6	Bushes - Stainless Steel and PTFE - Unflanged
177.800 -0.000/-0.180	182.372 +0.000/-0.160	63.500 +0.50/-0.50			BP17780-18237-06350-DP4	Bushes - Steel - DP4 - Split - Unflanged
177.800 -0.000/-0.180	182.372 +0.000/-0.160	63.500 +0.50/-0.50			BP17780-18237-06350-DU	Bushes - Steel - DU - Split - Unflanged
177.800 -0.000/-0.180	182.372 +0.000/-0.160	63.500 +0.25/-0.25			BP17780-18237-06350-SS6	Bushes - Stainless Steel and PTFE - Unflanged
177.800 -0.000/-0.180	182.372 +0.000/-0.160	76.200 +0.50/-0.50			BP17780-18237-07620-DP4	Bushes - Steel - DP4 - Split - Unflanged
177.800 -0.000/-0.180	182.372 +0.000/-0.160	76.200 +0.50/-0.50			BP17780-18237-07620-DU	Bushes - Steel - DU - Split - Unflanged
177.800 -0.000/-0.180	182.372 +0.000/-0.160	76.200 +0.25/-0.25			BP17780-18237-07620-SS6	Bushes - Stainless Steel and PTFE - Unflanged
177.800 -0.000/-0.180	182.372 +0.000/-0.160	88.900 +0.25/-0.25			BP17780-18237-08890-SS6	Bushes - Stainless Steel and PTFE - Unflanged
177.800 -0.000/-0.180	182.372 +0.000/-0.160	88.900 +0.50/-0.50			BP17780-18237-08890-DP4	Bushes - Steel - DP4 - Split - Unflanged
177.800 -0.000/-0.180	182.372 +0.000/-0.160	88.900 +0.50/-0.50			BP17780-18237-08890-DU	Bushes - Steel - DU - Split - Unflanged
177.800 -0.000/-0.180	182.372 +0.000/-0.160	95.250 +0.25/-0.25			BP17780-18237-09525-SS6	Bushes - Stainless Steel and PTFE - Unflanged
177.800 -0.000/-0.180	182.372 +0.000/-0.160	95.250 +0.50/-0.50			BP17780-18237-09525-DP4	Bushes - Steel - DP4 - Split - Unflanged
177.800 -0.000/-0.180	182.372 +0.000/-0.160	95.250 +0.50/-0.50			BP17780-18237-09525-DU	Bushes - Steel - DU - Split - Unflanged
177.800 -0.000/-0.180	182.372 +0.000/-0.160	101.600 +0.50/-0.50			BP17780-18237-10160-DP4	Bushes - Steel - DP4 - Split - Unflanged
177.800 -0.000/-0.180	182.372 +0.000/-0.160	101.600 +0.50/-0.50			BP17780-18237-10160-DU	Bushes - Steel - DU - Split - Unflanged
177.800 -0.000/-0.180	182.372 +0.000/-0.160	101.600 +0.25/-0.25			BP17780-18237-10160-SS6	Bushes - Stainless Steel and PTFE - Unflanged
177.800 -0.000/-0.180	182.372 +0.000/-0.160	114.300 +0.50/-0.50			BP17780-18237-11430-DP4	Bushes - Steel - DP4 - Split - Unflanged
177.800 -0.000/-0.180	182.372 +0.000/-0.160	114.300 +0.50/-0.50			BP17780-18237-11430-DU	Bushes - Steel - DU - Split - Unflanged
177.800 -0.000/-0.180	182.372 +0.000/-0.160	114.300 +0.25/-0.25			BP17780-18237-11430-SS6	Bushes - Stainless Steel and PTFE - Unflanged
177.800 -0.000/-0.180	182.372 +0.000/-0.160	120.650 +0.50/-0.50			BP17780-18237-12065-DP4	Bushes - Steel - DP4 - Split - Unflanged
177.800 -0.000/-0.180	182.372 +0.000/-0.160	120.650 +0.50/-0.50			BP17780-18237-12065-DU	Bushes - Steel - DU - Split - Unflanged
177.800 -0.000/-0.180	182.372 +0.000/-0.160	120.650 +0.25/-0.25			BP17780-18237-12065-SS6	Bushes - Stainless Steel and PTFE - Unflanged
180.000 x 185.000 mm (7.087 x 7.283 in.)						
180.000 -0.000/-0.063	185.000 +0.210/-0.000	50.000 +0.50/-0.50			BP18000-18500-05000-DX	Bushes - Steel - DX - Split - Unflanged
180.000 -0.000/-0.063	185.000 +0.210/-0.000	60.000 +0.50/-0.50			BP18000-18500-06000-DX	Bushes - Steel - DX - Split - Unflanged
180.000 -0.000/-0.063	185.000 +0.210/-0.000	80.000 +0.50/-0.50			BP18000-18500-08000-DP4	Bushes - Steel - DP4 - Split - Unflanged
180.000 -0.000/-0.063	185.000 +0.210/-0.000	80.000 +0.00/-0.40			BP18000-18500-08000-SS6	Bushes - Stainless Steel and PTFE - Unflanged
180.000 -0.000/-0.063	185.000 +0.210/-0.000	80.000 +0.50/-0.50			BP18000-18500-08000-DU	Bushes - Steel - DU - Split - Unflanged
180.000 -0.000/-0.063	185.000 +0.210/-0.000	80.000 +0.50/-0.50			BP18000-18500-08000-DX	Bushes - Steel - DX - Split - Unflanged

 Stocked or Short Delivery

 Usually Available

 Long delivery or not in current production

ID	OD	B	DF	bf	Part Number	Type
180.000 x 185.000 mm (7.087 x 7.283 in.)						
180.000 -0.000/-0.063	185.000 +0.210/-0.000	100.000 +0.50/-0.50			BP18000-18500-10000-DP4	Bushes - Steel - DP4 - Split - Unflanged
180.000 -0.000/-0.063	185.000 +0.210/-0.000	100.000 +0.50/-0.50			BP18000-18500-10000-DU	Bushes - Steel - DU - Split - Unflanged
180.000 -0.000/-0.063	185.000 +0.210/-0.000	100.000 +0.00/-0.40			BP18000-18500-10000-SS6	Bushes - Stainless Steel and PTFE - Unflanged
180.000 -0.000/-0.063	185.000 +0.210/-0.000	100.000 +0.50/-0.50			BP18000-18500-10000-DX	Bushes - Steel - DX - Split - Unflanged
190.000 x 195.000 mm (7.480 x 7.677 in.)						
190.000 -0.000/-0.072	195.000 +0.210/-0.000	50.000 +0.50/-0.50			BP19000-19500-05000-DX	Bushes - Steel - DX - Split - Unflanged
190.000 -0.000/-0.072	195.000 +0.210/-0.000	60.000 +0.50/-0.50			BP19000-19500-06000-DX	Bushes - Steel - DX - Split - Unflanged
190.000 -0.000/-0.072	195.000 +0.210/-0.000	80.000 +0.50/-0.50			BP19000-19500-08000-DP4	Bushes - Steel - DP4 - Split - Unflanged
190.000 -0.000/-0.072	195.000 +0.210/-0.000	80.000 +0.50/-0.50			BP19000-19500-08000-DU	Bushes - Steel - DU - Split - Unflanged
190.000 -0.000/-0.072	195.000 +0.210/-0.000	80.000 +0.00/-0.40			BP19000-19500-08000-SS6	Bushes - Stainless Steel and PTFE - Unflanged
190.000 -0.000/-0.072	195.000 +0.210/-0.000	80.000 +0.50/-0.50			BP19000-19500-08000-DX	Bushes - Steel - DX - Split - Unflanged
190.000 -0.000/-0.072	195.000 +0.210/-0.000	100.000 +0.00/-0.40			BP19000-19500-10000-SS6	Bushes - Stainless Steel and PTFE - Unflanged
190.000 -0.000/-0.072	195.000 +0.210/-0.000	100.000 +0.50/-0.50			BP19000-19500-10000-DP4	Bushes - Steel - DP4 - Split - Unflanged
190.000 -0.000/-0.072	195.000 +0.210/-0.000	100.000 +0.50/-0.50			BP19000-19500-10000-DU	Bushes - Steel - DU - Split - Unflanged
190.000 -0.000/-0.072	195.000 +0.210/-0.000	100.000 +0.50/-0.50			BP19000-19500-10000-DX	Bushes - Steel - DX - Split - Unflanged
190.000 -0.000/-0.072	195.000 +0.210/-0.000	120.000 +0.50/-0.50			BP19000-19500-12000-DX	Bushes - Steel - DX - Split - Unflanged
200.000 x 205.000 mm (7.874 x 8.071 in.)						
200.000 -0.000/-0.072	205.000 +0.210/-0.000	50.000 +0.50/-0.50			BP20000-20500-05000-DX	Bushes - Steel - DX - Split - Unflanged
200.000 -0.000/-0.072	205.000 +0.210/-0.000	60.000 +0.50/-0.50			BP20000-20500-06000-DP4	Bushes - Steel - DP4 - Split - Unflanged
200.000 -0.000/-0.072	205.000 +0.210/-0.000	60.000 +0.50/-0.50			BP20000-20500-06000-DU	Bushes - Steel - DU - Split - Unflanged
200.000 -0.000/-0.072	205.000 +0.210/-0.000	60.000 +0.00/-0.40			BP20000-20500-06000-SS6	Bushes - Stainless Steel and PTFE - Unflanged
200.000 -0.000/-0.072	205.000 +0.210/-0.000	60.000 +0.50/-0.50			BP20000-20500-06000-DX	Bushes - Steel - DX - Split - Unflanged
200.000 -0.000/-0.072	205.000 +0.210/-0.000	80.000 +0.50/-0.50			BP20000-20500-08000-DP4	Bushes - Steel - DP4 - Split - Unflanged
200.000 -0.000/-0.072	205.000 +0.210/-0.000	80.000 +0.50/-0.50			BP20000-20500-08000-DU	Bushes - Steel - DU - Split - Unflanged
200.000 -0.000/-0.072	205.000 +0.210/-0.000	80.000 +0.00/-0.40			BP20000-20500-08000-SS6	Bushes - Stainless Steel and PTFE - Unflanged
200.000 -0.000/-0.072	205.000 +0.210/-0.000	80.000 +0.50/-0.50			BP20000-20500-08000-DX	Bushes - Steel - DX - Split - Unflanged
200.000 -0.000/-0.072	205.000 +0.210/-0.000	100.000 +0.00/-0.40			BP20000-20500-10000-SS6	Bushes - Stainless Steel and PTFE - Unflanged
200.000 -0.000/-0.072	205.000 +0.210/-0.000	100.000 +0.50/-0.50			BP20000-20500-10000-DP4	Bushes - Steel - DP4 - Split - Unflanged
200.000 -0.000/-0.072	205.000 +0.210/-0.000	100.000 +0.50/-0.50			BP20000-20500-10000-DU	Bushes - Steel - DU - Split - Unflanged
200.000 -0.000/-0.072	205.000 +0.210/-0.000	100.000 +0.50/-0.50			BP20000-20500-10000-DX	Bushes - Steel - DX - Split - Unflanged
200.000 -0.000/-0.072	205.000 +0.210/-0.000	120.000 +0.50/-0.50			BP20000-20500-12000-DX	Bushes - Steel - DX - Split - Unflanged
210.000 x 215.000 mm (8.268 x 8.465 in.)						
210.000 -0.000/-0.072	215.000 +0.210/-0.000	100.000 +0.50/-0.50			BP21000-21500-10000-DU	Bushes - Steel - DU - Split - Unflanged
220.000 x 225.000 mm (8.661 x 8.858 in.)						
220.000 -0.000/-0.072	225.000 +0.210/-0.000	50.000 +0.50/-0.50			BP22000-22500-05000-DX	Bushes - Steel - DX - Split - Unflanged
220.000 -0.000/-0.072	225.000 +0.210/-0.000	60.000 +0.50/-0.50			BP22000-22500-06000-DX	Bushes - Steel - DX - Split - Unflanged
220.000 -0.000/-0.072	225.000 +0.210/-0.000	80.000 +0.00/-0.40			BP22000-22500-08000-SS6	Bushes - Stainless Steel and PTFE - Unflanged
220.000 -0.000/-0.072	225.000 +0.210/-0.000	80.000 +0.50/-0.50			BP22000-22500-08000-DP4	Bushes - Steel - DP4 - Split - Unflanged
220.000 -0.000/-0.072	225.000 +0.210/-0.000	80.000 +0.50/-0.50			BP22000-22500-08000-DU	Bushes - Steel - DU - Split - Unflanged
220.000 -0.000/-0.072	225.000 +0.210/-0.000	80.000 +0.50/-0.50			BP22000-22500-08000-DX	Bushes - Steel - DX - Split - Unflanged

 Stocked or Short Delivery

 Usually Available

 Long delivery or not in current production

ID	OD	B	DF	bf	Part Number	Type
220.000 x 225.000 mm (8.661 x 8.858 in.)						
220.000 -0.000/-0.072	225.000 +0.210/-0.000	100.000 +0.00/-0.40			BP22000-22500-10000-SS6	Bushes - Stainless Steel and PTFE - Unflanged
220.000 -0.000/-0.072	225.000 +0.210/-0.000	100.000 +0.50/-0.50			BP22000-22500-10000-DP4	Bushes - Steel - DP4 - Split - Unflanged
220.000 -0.000/-0.072	225.000 +0.210/-0.000	100.000 +0.50/-0.50			BP22000-22500-10000-DU	Bushes - Steel - DU - Split - Unflanged
220.000 -0.000/-0.072	225.000 +0.210/-0.000	100.000 +0.50/-0.50			BP22000-22500-10000-DX	Bushes - Steel - DX - Split - Unflanged
220.000 -0.000/-0.072	225.000 +0.210/-0.000	120.000 +0.50/-0.50			BP22000-22500-12000-DX	Bushes - Steel - DX - Split - Unflanged
240.000 x 245.000 mm (9.449 x 9.646 in.)						
240.000 -0.000/-0.072	245.000 +0.260/-0.000	50.000 +0.50/-0.50			BP24000-24500-05000-DX	Bushes - Steel - DX - Split - Unflanged
240.000 -0.000/-0.072	245.000 +0.260/-0.000	60.000 +0.50/-0.50			BP24000-24500-06000-DX	Bushes - Steel - DX - Split - Unflanged
240.000 -0.000/-0.072	245.000 +0.260/-0.000	80.000 +0.50/-0.50			BP24000-24500-08000-DX	Bushes - Steel - DX - Split - Unflanged
240.000 -0.000/-0.072	245.000 +0.260/-0.000	100.000 +0.50/-0.50			BP24000-24500-10000-DX	Bushes - Steel - DX - Split - Unflanged
240.000 -0.000/-0.072	245.000 +0.260/-0.000	120.000 +0.50/-0.50			BP24000-24500-12000-DX	Bushes - Steel - DX - Split - Unflanged
250.000 x 255.000 mm (9.843 x 10.039 in.)						
250.000 -0.000/-0.072	255.000 +0.260/-0.000	50.000 +0.50/-0.50			BP25000-25500-05000-DX	Bushes - Steel - DX - Split - Unflanged
250.000 -0.000/-0.072	255.000 +0.260/-0.000	60.000 +0.50/-0.50			BP25000-25500-06000-DX	Bushes - Steel - DX - Split - Unflanged
250.000 -0.000/-0.072	255.000 +0.260/-0.000	80.000 +0.00/-0.40			BP25000-25500-08000-SS6	Bushes - Stainless Steel and PTFE - Unflanged
250.000 -0.000/-0.072	255.000 +0.260/-0.000	80.000 +0.50/-0.50			BP25000-25500-08000-DP4	Bushes - Steel - DP4 - Split - Unflanged
250.000 -0.000/-0.072	255.000 +0.260/-0.000	80.000 +0.50/-0.50			BP25000-25500-08000-DU	Bushes - Steel - DU - Split - Unflanged
250.000 -0.000/-0.072	255.000 +0.260/-0.000	80.000 +0.50/-0.50			BP25000-25500-08000-DX	Bushes - Steel - DX - Split - Unflanged
250.000 -0.000/-0.072	255.000 +0.260/-0.000	100.000 +0.00/-0.40			BP25000-25500-10000-SS6	Bushes - Stainless Steel and PTFE - Unflanged
250.000 -0.000/-0.072	255.000 +0.260/-0.000	100.000 +0.50/-0.50			BP25000-25500-10000-DP4	Bushes - Steel - DP4 - Split - Unflanged
250.000 -0.000/-0.072	255.000 +0.260/-0.000	100.000 +0.50/-0.50			BP25000-25500-10000-DU	Bushes - Steel - DU - Split - Unflanged
250.000 -0.000/-0.072	255.000 +0.260/-0.000	100.000 +0.50/-0.50			BP25000-25500-10000-DX	Bushes - Steel - DX - Split - Unflanged
250.000 -0.000/-0.072	255.000 +0.260/-0.000	120.000 +0.50/-0.50			BP25000-25500-12000-DX	Bushes - Steel - DX - Split - Unflanged
260.000 x 265.000 mm (10.236 x 10.433 in.)						
260.000 -0.000/-0.081	265.000 +0.260/-0.000	50.000 +0.50/-0.50			BP26000-26500-05000-DX	Bushes - Steel - DX - Split - Unflanged
260.000 -0.000/-0.081	265.000 +0.260/-0.000	60.000 +0.50/-0.50			BP26000-26500-06000-DX	Bushes - Steel - DX - Split - Unflanged
260.000 -0.000/-0.081	265.000 +0.260/-0.000	80.000 +0.00/-0.40			BP26000-26500-08000-SS6	Bushes - Stainless Steel and PTFE - Unflanged
260.000 -0.000/-0.081	265.000 +0.260/-0.000	80.000 +0.50/-0.50			BP26000-26500-08000-DP4	Bushes - Steel - DP4 - Split - Unflanged
260.000 -0.000/-0.081	265.000 +0.260/-0.000	80.000 +0.50/-0.50			BP26000-26500-08000-DU	Bushes - Steel - DU - Split - Unflanged
260.000 -0.000/-0.081	265.000 +0.260/-0.000	80.000 +0.50/-0.50			BP26000-26500-08000-DX	Bushes - Steel - DX - Split - Unflanged
260.000 -0.000/-0.081	265.000 +0.260/-0.000	100.000 +0.50/-0.50			BP26000-26500-10000-DP4	Bushes - Steel - DP4 - Split - Unflanged
260.000 -0.000/-0.081	265.000 +0.260/-0.000	100.000 +0.50/-0.50			BP26000-26500-10000-DU	Bushes - Steel - DU - Split - Unflanged
260.000 -0.000/-0.081	265.000 +0.260/-0.000	100.000 +0.00/-0.40			BP26000-26500-10000-SS6	Bushes - Stainless Steel and PTFE - Unflanged
260.000 -0.000/-0.081	265.000 +0.260/-0.000	100.000 +0.50/-0.50			BP26000-26500-10000-DX	Bushes - Steel - DX - Split - Unflanged
260.000 -0.000/-0.081	265.000 +0.260/-0.000	120.000 +0.50/-0.50			BP26000-26500-12000-DX	Bushes - Steel - DX - Split - Unflanged
280.000 x 285.000 mm (11.024 x 11.220 in.)						
280.000 -0.000/-0.081	285.000 +0.260/-0.000	50.000 +0.50/-0.50			BP28000-28500-05000-DX	Bushes - Steel - DX - Split - Unflanged
280.000 -0.000/-0.081	285.000 +0.260/-0.000	60.000 +0.50/-0.50			BP28000-28500-06000-DX	Bushes - Steel - DX - Split - Unflanged
280.000 -0.000/-0.081	285.000 +0.260/-0.000	80.000 +0.50/-0.50			BP28000-28500-08000-DP4	Bushes - Steel - DP4 - Split - Unflanged
280.000 -0.000/-0.081	285.000 +0.260/-0.000	80.000 +0.50/-0.50			BP28000-28500-08000-DU	Bushes - Steel - DU - Split - Unflanged

 Stocked or Short Delivery

 Usually Available

 Long delivery or not in current production

ID	OD	B	DF	bf	Part Number	Type
280.000 x 285.000 mm (11.024 x 11.220 in.)						
280.000 -0.000/-0.081	285.000 +0.260/-0.000	80.000 +0.00/-0.40			BP28000-28500-08000-SS6	Bushes - Stainless Steel and PTFE - Unflanged
280.000 -0.000/-0.081	285.000 +0.260/-0.000	80.000 +0.50/-0.50			BP28000-28500-08000-DX	Bushes - Steel - DX - Split - Unflanged
280.000 -0.000/-0.081	285.000 +0.260/-0.000	100.000 +0.50/-0.50			BP28000-28500-10000-DP4	Bushes - Steel - DP4 - Split - Unflanged
280.000 -0.000/-0.081	285.000 +0.260/-0.000	100.000 +0.00/-0.40			BP28000-28500-10000-SS6	Bushes - Stainless Steel and PTFE - Unflanged
280.000 -0.000/-0.081	285.000 +0.260/-0.000	100.000 +0.50/-0.50			BP28000-28500-10000-DU	Bushes - Steel - DU - Split - Unflanged
280.000 -0.000/-0.081	285.000 +0.260/-0.000	100.000 +0.50/-0.50			BP28000-28500-10000-DX	Bushes - Steel - DX - Split - Unflanged
280.000 -0.000/-0.081	285.000 +0.260/-0.000	120.000 +0.50/-0.50			BP28000-28500-12000-DX	Bushes - Steel - DX - Split - Unflanged
300.000 x 305.000 mm (11.811 x 12.008 in.)						
300.000 -0.000/-0.081	305.000 +0.260/-0.000	50.000 +0.50/-0.50			BP30000-30500-05000-DX	Bushes - Steel - DX - Split - Unflanged
300.000 -0.000/-0.081	305.000 +0.260/-0.000	60.000 +0.50/-0.50			BP30000-30500-06000-DX	Bushes - Steel - DX - Split - Unflanged
300.000 -0.000/-0.081	305.000 +0.260/-0.000	80.000 +0.50/-0.50			BP30000-30500-08000-DP4	Bushes - Steel - DP4 - Split - Unflanged
300.000 -0.000/-0.081	305.000 +0.260/-0.000	80.000 +0.50/-0.50			BP30000-30500-08000-DU	Bushes - Steel - DU - Split - Unflanged
300.000 -0.000/-0.081	305.000 +0.260/-0.000	80.000 +0.00/-0.40			BP30000-30500-08000-SS6	Bushes - Stainless Steel and PTFE - Unflanged
300.000 -0.000/-0.081	305.000 +0.260/-0.000	80.000 +0.50/-0.50			BP30000-30500-08000-DX	Bushes - Steel - DX - Split - Unflanged
300.000 -0.000/-0.081	305.000 +0.260/-0.000	100.000 +0.50/-0.50			BP30000-30500-10000-DP4	Bushes - Steel - DP4 - Split - Unflanged
300.000 -0.000/-0.081	305.000 +0.260/-0.000	100.000 +0.00/-0.40			BP30000-30500-10000-SS6	Bushes - Stainless Steel and PTFE - Unflanged
300.000 -0.000/-0.081	305.000 +0.260/-0.000	100.000 +0.50/-0.50			BP30000-30500-10000-DU	Bushes - Steel - DU - Split - Unflanged
300.000 -0.000/-0.081	305.000 +0.260/-0.000	100.000 +0.50/-0.50			BP30000-30500-10000-DX	Bushes - Steel - DX - Split - Unflanged
300.000 -0.000/-0.081	305.000 +0.260/-0.000	120.000 +0.50/-0.50			BP30000-30500-12000-DX	Bushes - Steel - DX - Split - Unflanged

Stocked or Short Delivery

Usually Available

Long delivery or not in current production

MAIN PRODUCT GROUPS

Balls	Keysteel
Bearings	Knobs
Bushes	Mounts
Carbon Fibre	Pins
Couplings	Screws
Dowel Pins	Springs
Fasteners	Timing Belts
Gears	Timing Pulleys
	Washers

Simply type the description into the search box on our website at <http://www.minibearings.com.au/> for more information and size listings for all of these products and many more



Distributed By

Miniature Bearings Australia
<http://www.minibearings.com.au>
sales@minibearings.com.au

Resellers: Please place your contact sticker over our details

Avoid verbal communication

We sell an extensive range of products with varying amounts of technical data. Please assist us to provide you with accurate information by placing your orders and enquiries online or by e-mail.

Bushes - Metallic 2017